

www.epson.co.id/projectors

3LCD PROJECTOR



22 YEARS RUNNING SINCE 2001-2022
SOURCE: FUTURESOURCE CONSULTING



3LCD PROJECTOR

MENGAPA MEMILIH 3LCD PROJECTOR ?

Projektor Epson 3LCD menghadirkan warna-warna menakjubkan dengan tingkat kecerahan yang seimbang, realistis, dan hasil gambar yang lebih hidup. Tidak heran jika proyektor Epson adalah pilihan utama masyarakat.



EPSON 3LCD TECHNOLOGY UNTUK WARNA CERAH & LEBIH NYATA

3LCD projectors offer brighter and more accurate as they produce different shades and hues by filtering, then mixing beams of the three primary colours (red, green and blue).

In a 3LCD projector, white light is first split into the three beams of primary colours. Each beam is then filtered through its own LCD that will give each individual pixel of the image its exact brightness for each colour. The colour beams are then perfectly recombined in a prism before being projected out as a complete image.

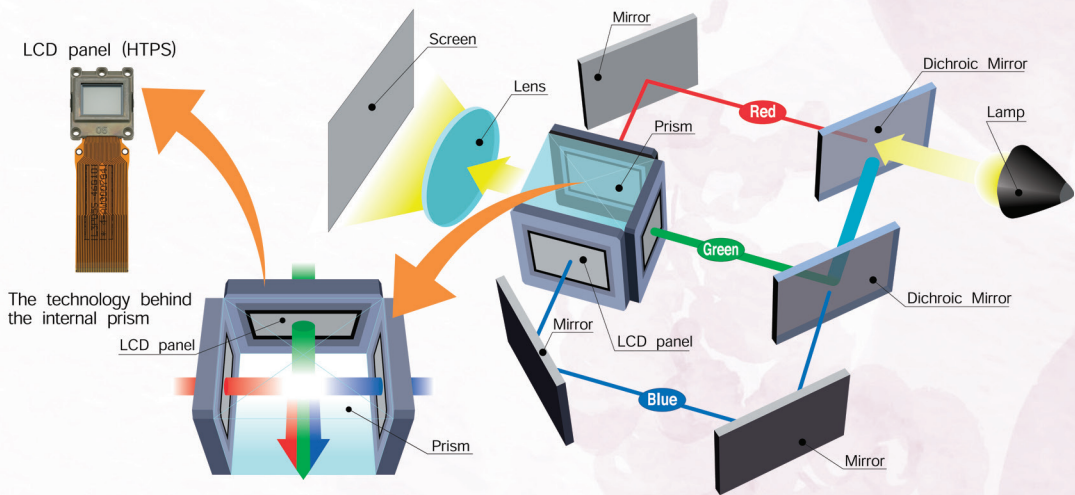

3LCD PROJECTOR

Small Sized Rooms

3LCD PROJECTOR

EB-E01



Brightness 3,300 lm	Resolution XGA	Contrast 15,000:1
Light Source Life 6,000/12,000 hrs	Keystone ±30° (V) / ±30° (H)	Connectivity USB Type-B x 1, VGA x 1, HDMI x 1
Network N/A	Power Consumption 327W / 225W	Weight 2.4 kg



12,000 Hours
Lamp Life in Eco Mode



Split Screen

EB-X06



Brightness 3,600 lm	Resolution XGA	Contrast 16,000:1
Light Source Life 6,000/12,000 hrs	Keystone ±30° (V) / ±30° (H)	Connectivity USB Type-B x 1, VGA x 1, HDMI x 1
Network Optional (ELPAP11)	Power Consumption 327W / 225W	Weight 2.5 kg



12,000 Hours
Lamp Life in Eco Mode



Split Screen



Auto Vertical
Keystone



Horizontal
Keystone Adjuster



Wireless
iProjection

3LCD PROJECTOR

EB-E10



Brightness 3,600 lm	Resolution XGA	Contrast 15,000:1
Light Source Life 6,000/12,000 hrs	Keystone ±30° (V) / ±30° (H)	Connectivity USB Type-B x 1, VGA x 1, HDMI x 1
Network N/A	Power Consumption 327W / 225W	Weight 2.4 kg



12,000 Hours
Lamp Life in Eco Mode



Split Screen

EB-E500

E500 untuk Indonesia



Brightness 3,300 lm	Resolution XGA	Contrast 15,000:1
Light Source Life 6,000/12,000 hrs	Keystone ±30° (V) / ±30° (H)	Connectivity USB Type-B x 1, VGA x 1, HDMI x 1
Network N/A	Power Consumption 327W / 225W	Weight 2.4 kg



12,000 Hours
Lamp Life in Eco Mode



Split Screen

3LCD PROJECTOR

Small Sized Rooms

3LCD PROJECTOR

EB-X500

X500 untuk Indonesia



Brightness 3,600 lm	Resolution XGA	Contrast 16,000:1
Light Source Life 6,000/12,000 hrs	Keystone ±30° (V) / ±30° (H)	Connectivity USB Type-A & Bx1 VGA x1, HDMI x1,
Network Optional (ELPAP11)	Power Consumption 327W / 225W	Weight 2.5 kg



12,000 Hours
Lamp Life in Eco Mode



Split Screen



Auto Vertical
Keystone



Horizontal Keystone
Adjuster*



Wireless
iProjection

EB-X51



Brightness 3,800 lm	Resolution XGA	Contrast 16,000:1
Light Source Life 6,000/12,000 hrs	Keystone ±30° (V) / ±30° (H)	Connectivity HDMI in x1, VGA in x1 RCA x1, 2RCA x1 USB Type-A & Bx1
Network Optional (ELPAP11)	Power Consumption 327W / 225W	Weight 2.5 kg



12,000 Hours
Lamp Life in Eco Mode



Split Screen



Auto Vertical
Keystone



Horizontal Keystone
Adjuster*



Wireless
iProjection

3LCD PROJECTOR

EB-W06



Brightness 3,700 lm	Resolution WXGA	Contrast 16,000:1
Light Source Life 6,000/12,000 hrs	Keystone ±30° (V) / ±30° (H)	Connectivity HDMI in x1, VGA in x1 RCA x1, 2RCA x1 USB Type-A & Bx1
Network Optional (ELPAP11)	Power Consumption 327W / 225W	Weight 2.5 kg



12,000 Hours
Lamp Life in Eco Mode



Split Screen



Auto Vertical
Keystone



Horizontal Keystone
Adjuster*



Wireless
iProjection

EB-W51



Brightness 4,000 lm	Resolution WXGA	Contrast 16,000:1
Light Source Life 6,000/12,000 hrs	Keystone ±30° (V) / ±30° (H)	Connectivity HDMI in x1, VGA in x1 RCA x1, 2RCA x1 USB Type-A & Bx1
Network Optional (ELPAP11)	Power Consumption 327W / 225W	Weight 2.5 kg



12,000 Hours
Lamp Life in Eco Mode



Split Screen



Auto Vertical
Keystone



Horizontal Keystone
Adjuster*



Wireless
iProjection

3LCD PROJECTOR

Small Sized Rooms

3LCD PROJECTOR

EB-FH52



Brightness 4,000 lm	Resolution 1080p	Contrast 16,000:1
Light Source Life 5,500/12,000 hrs	Keystone ±30° (V) / ±30° (H)	Connectivity HDMI in x2, VGA in x1 RCA x1, 2RCA x1 USB Type-A & Bx1
Network Built-in Support Screen Mirroring	Power Consumption 327W / 225W	Weight 3.1 kg



12,000 Hours
Lamp Life in Eco Mode



Split Screen



Auto Vertical
Keystone



Horizontal Keystone
Slider



Wireless iProjection
/ Screen Mirroring



Full HD
Resolution

EB-972



Brightness 4,100 lm	Resolution XGA	Contrast 16,000:1
Light Source Life 6,500/17,000 hrs	Keystone ±30° (V) / ±30° (H)	Connectivity HDMI in x2, VGA in x1, VGA out x1, RCA in x1, 2RCA x1 Stereo Mini Jack in x2 USB Type-A & Bx1
Network Optional (ELPAP11)	Power Consumption 327W / 225W	Weight 3.1 kg



17,000 Hours
Lamp Life in Eco Mode



Split Screen



Auto Vertical
Keystone



Horizontal Keystone
Slider



Wireless
iProjection

3LCD PROJECTOR

EB-982W



Brightness 4,200 lm	Resolution WXGA	Contrast 16,000:1
Light Source Life 6,500/17,000 hrs	Keystone ±30° (V) / ±30° (H)	Connectivity HDMI in x2, VGA in x1, VGA out x1, RCA in x1, 2RCA x1 Stereo Mini Jack in x2 Stereo Mini Jack out x1 USB Type-A & Bx1
Network Optional (ELPAP11)	Power Consumption 327W / 225W	Weight 3.1 kg



17,000 Hours
Lamp Life in Eco Mode



Split Screen



Auto Vertical
Keystone



Horizontal Keystone
Slider



Wireless
iProjection

Ultra Portable Projectors

EB-1785W Gesture Presenter



Brightness 3,200lm	Resolution WXGA	Contrast 10,000:1
Light Source Life 4,000 / 7,000 hrs	Keystone ±45°(V) / ±30°(H)	Connectivity VGA in x1, HDMI in x1 (Support MHL) Stereo Mini Jack in x1 USB Type-A & Bx1
Network Built-in Support Screen Mirroring	Power Consumption 295W / 208W	Weight 1.81 kg



Gesture
Presenter



NFC



Wireless
Projection



Real-Time Auto V/H
Keystone Correction



Split Screen

3LCD PROJECTOR

Ultra Portable Projectors



reddot design award



EB-1795F Gesture Presenter

Brightness 3,200lm	Resolution 1080p	Contrast 10,000:1
Light Source Life 4,000 / 7,000 hrs	Keystone ±45°(V) / ±30°(H)	Connectivity HDMI in x1 (Support MHL) VGA in x1, RCA x1 Stereo Mini Jack in x1 USB Type-A & Bx1
Network Built-in Support Screen Mirroring	Power Consumption 295W / 208W	Weight 1.83 kg



Gesture Presenter



NFC



Wireless Projection



Real-Time Auto V/H
Keystone Correction



Split Screen



Full HD

Mid Size Rooms Projectors

EB-2265U Gesture Presenter



Brightness 5,500lm	Resolution WUXGA	Contrast 15,000:1
Light Source Life 5,000 / 10,000 hrs	Keystone ±30°(V) / ±30°(H)	Connectivity HDBaset x1, HDMI in x2 (1 Support MHL) VGA in x2, VGA out x1 Stereo Mini Jack in x2 Stereo Mini Jack out x1 2RCA x1, RCA x1, RS-232C x1, RJ45 x1 USB Type-A & Bx1
Network Optional (ELPAP10)	Power Consumption 425W / 323W	Weight 4.7 kg



Gesture Presenter



Multi-PC Projection



Wireless Projection



Split Screen

3LCD PROJECTOR

EB-2155W



Brightness 5,000lm	Resolution WXGA	Contrast 15,000:1
Light Source Life 5,000 / 10,000 hrs	Keystone ±30°(V) / ±30°(H)	Connectivity HDMI in x2 (1 Support MHL) VGA in x2, VGA out x1 Stereo Mini Jack in x2 Stereo Mini Jack out x1 2RCA x1, RCA x1, RS-232C x1, RJ45 x1 USB Type-A & Bx1
Network Optional (ELPAP10)	Power Consumption 405W / 323W	Weight 4.3 kg



Gesture Presenter



Multi-PC Projection



Wireless Projection



Split Screen

EB-L630U



EB-L630U/EB-L730U



Wireless Projection



Flexible 360 degree installation



WUXGA Resolution



Edge Blending Technology

Brightness 6,200 lm	Resolution WUXGA (16:10)	Contrast over 2,500,000 : 1
Light Source Life 20,000 hours	Keystone ±30°(V) / ±30°(H)	Connectivity D-Sub 15Pin IN x 2, HDMI In x 2, HDBaseT RJ45 In x 1, D-Sub 15Pin Out x 1, Stereo Mini Jack In x 2, Stereo Mini Jack Out x 1, USB Type A x 1, USB Type B x 1, RS-232C D-Sub 15Pin x 1, Wired Lan RJ45 x 1, HDMI Out x1
Network Built-In	Power Consumption 345W / 258W	Weight Approx 8.4 Kg

EB-L730U

Brightness 7,000 lm	Resolution WUXGA (16:10)	Contrast over 2,500,000 : 1
Light Source Life 20,000 hours	Keystone ±30°(V) / ±30°(H)	Connectivity D-Sub 15Pin IN x 2, HDMI In x 2, HDBaseT RJ45 In x 1, D-Sub 15Pin Out x 1, Stereo Mini Jack In x 2, Stereo Mini Jack Out x 1, USB Type A x 1, USB Type B x 1, RS-232C D-Sub 15Pin x 1, Wired Lan RJ45 x 1, HDMI Out x1
Network Built-In	Power Consumption 345W / 258W	Weight Approx 8.4 Kg

3LCD PROJECTOR

Ultra Portable Projectors

EB-2065



Brightness 5,500lm	Resolution XGA	Contrast 15,000:1
Light Source Life 5,000 / 10,000 hrs	Keystone ±30°(V) / ±30°(H)	Connectivity HDMI in x2 (1 Support MHL) VGA in x2, VGA out x1 2RCA x1, RCA x1, RS-232C x1, RJ45 x1 Stereo Mini Jack in x2 Stereo Mini Jack out x1 USB Type-A & Bx1
Network Optional (ELPAP10)	Power Consumption 425W / 323W	Weight 4.4 kg



Gesture
Presenter



Multi-PC
Projection



Wireless
Projection



Split Screen

EB-L520U



Brightness 5,200lm	Resolution WUXGA (1920 x 1200)	Contrast over 2,500,000 : 1
Light Source Life 20,000 hours	Keystone ±30°(V) / ±30°(H)	Connectivity D-Sub 15Pin IN x 2, HDMI In x 2, HDBaseT RJ45 In x 1, D-Sub 15Pin Out x 1, Stereo Mini Jack In x 2, Stereo Mini Jack Out x 1, USB Type A x 1, USB Type B x 1, RS-232C D-Sub 9Pin x 1, Wired Lan RJ45 x 1,
Network Optional (ELPAP11)	Power Consumption 293W/233W	Weight Approx 7.7 Kg



Split Screen

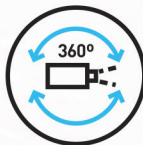

Flexible
360 degree
installation

3LCD PROJECTOR

Business Projector

EB-L210W



Brightness 4,500lm / 3,100lm	Resolution WXGA (1280 x 800)	Contrast Over 2,500,000 : 1
Light Source Life 20,000 / 30,000 hrs	Keystone ±30° (V) / ±30° (H)	Connectivity -HDMI 2 (HDCP 2.3) -D-Sub 15Pin (1 [Black] lin common with Computer 2) -RCA 2 (White, Red) -Stereo Mini Jack (2) -USB Type A & B
Network -Wired LAN : RJ45 x 1 (100Mbps) -Wireless : Built-in*2 and Optional (Using ELPAP11)	Power Consumption -Lamp On (Normal / Extended) : 260W / 191W - Standby (Network On / Off) : 2.0W / 0.5W	Weight Approx. 4.2kg



30,000 Hours Lamp Life in Eco Mode



Split Screen



Auto Vertical Keystone



Horizontal Keystone Adjuster



Wi-Fi Connection



3LCD PROJECTOR

EB-L260F



Brightness 4,600lm / 3,200lm	Resolution Full HD (1080p)	Contrast Over 2,500,000 : 1
Light Source Life 20,000 / 30,000 hrs	Keystone ±30° (V) / ±30° (H)	Connectivity -HDMI 2 (HDCP 2.3) -D-Sub 15Pin (1 [Black] lin common with Computer 2) -RCA 2 (White, Red) -Stereo Mini Jack (2) -USB Type A & B
Network -Wired LAN : RJ45 x 1 (100Mbps) -Wireless : Built-in*2 and Optional (Using ELPAP11)	Power Consumption -Lamp On (Normal / Extended) : 260W / 191W - Standby (Network On / Off) : 2.0W / 0.5W	Weight Approx. 4.2kg



30,000 Hours Lamp Life in Eco Mode



Split Screen



Auto Vertical Keystone



Horizontal Keystone Adjuster



Wi-Fi Connection



3LCD PROJECTOR

Short Throw Projectors



EB-L210SW

Brightness 4,000lm / 2,800lm	Resolution WXGA (1280 x 800)	Contrast over 2,500,000 : 1
Light Source Life Type : Laser Diode Life (Normal / Quiet / Extended) : 20,000 / 20,000 / 30,000 hrs	Keystone ±15°(V) / ±15°(H)	Connectivity HDMI 2 (HDCP 2.3) D Sub 15 Pin RCA Stereo Mini Jack USB Type A & B
Network Wired LAN : RJ45 x 1 (100Mbps) Wireless : Built-in*2 and Optional wireless (using ELPAP11)	Power Consumption Lamp On (Normal / Extended) 260W / 191W Standby (Network On / Off) 2.0W / 0.5W	Weight Approx 4.6 Kg

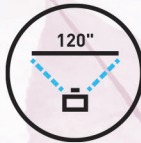

Short Throw



30,000 Light Hours



Wi-Fi Connection



Multi-PC Projection



EB-L210SF

Brightness 4,000lm / 2,800lm	Resolution Full HD (1080p)	Contrast over 2,500,000 : 1
Light Source Life Type : Laser Diode Life (Normal / Quiet / Extended) : 20,000 / 20,000 / 30,000 hrs	Keystone ±15°(V) / ±15°(H)	Connectivity HDMI 2 (HDCP 2.3) D Sub 15 Pin RCA Stereo Mini Jack USB Type A & B
Network Wired LAN : RJ45 x 1 (100Mbps) Wireless : Built-in*2 and Optional wireless (using ELPAP11)*	Power Consumption Lamp On (Normal / Extended) 260W / 191W Standby (Network On / Off) 2.0W / 0.5W	Weight Approx 4.6 Kg



Short Throw



30,000 Light Hours



Wi-Fi Connection



Multi-PC Projection

3LCD PROJECTOR

EB-L630SU



Brightness 6,000 lm	Resolution WUXGA (16:10)	Contrast over 2,500,000 : 1
Light Source Life 20,000 hours	Keystone ±30°(V) / ±30°(H)	Connectivity D-Sub 15Pin IN x 2, HDMI In x 2, HDbaseT RJ45 In x 1, D-Sub 15Pin Out x 1, Stereo Mini Jack In x 2, Stereo Mini Jack Out x 1, USB Type A x 1, USB Type B x 1, RS-232C D-Sub 15Pin x 1, Wired Lan RJ45 x 1, HDMI Out x1
Network Built-In	Power Consumption 345W / 258W	Weight Approx 8.4 Kg



Wireless Projection

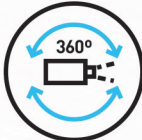

Flexible 360 degree installation



WUXGA Resolution



Edge Blending Technology



Lightning Scene

EB-W50



Brightness 3,800 lm	Resolution WXGA (1280 x 800)	Contrast 16,000:1
Light Source Life 10,000 hours (Normal), 17,000 hours (Eco)	Keystone ±30° (V) / ±30° (H)	Connectivity D-Sub 15 Pin In x 2, HDMI In x 2, D-Sub 15Pin Out x 1, Stereo Mini Jack In x 2, Stereo Mini Jack Out x 1, USB Type A x 1, USB Type B x 1, RS-232C D-Sub 9pin x 1, Wired LAN RJ45 x 1
Network Wireless ELPAP10 (Optional)	Power Consumption 285 W / 218 W	Weight 3.1 kg



17,000 Hours Lamp Life in Eco Mode



Split Screen



Auto Vertical Keystone



Dust Resistance Design



USB Direct Playback

3LCD PROJECTOR

Lighting Scene

EB-U50



Brightness 3,700 lm	Resolution WUXGA	Contrast 16,000:1
Light Source Life 10,000/17,000 hrs	Keystone ±30° (V) / ±30° (H)	Connectivity HDMI in x2, VGA in x2 VGA out x1, RJ45 x1 Stereo Mini Jack out x2 USB Type-A & Bx1
Network Built-in	Power Consumption 285W / 218W	Weight 3.1 kg



17,000 Hours
Lamp Life in Eco Mode



Split Screen



Auto Vertical
Keystone



Dust Resistance
Design



USB Direct
Playback

EV-110/EV-115

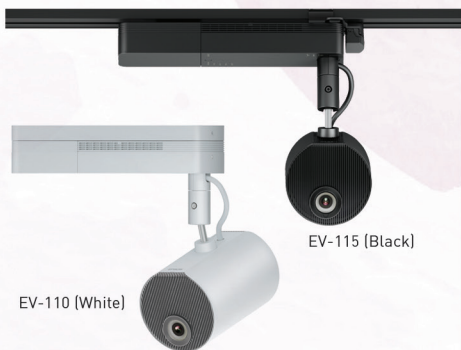

EV-110 (White)

EV-115 (Black)

Brightness 2,200lm	Resolution WXGA	Contrast >2,500,000:1
Laser Light Source 20,000 hrs	Keystone ±45°(V) / ±40°(H)	Connectivity HDMI in x1 SD Card x1, RJ45 x1 Stereo Mini Jack out x1 USB Type-A & Bx1
Network Built-in	Power Consumption 149W / 112W	Weight 6.9 kg (Exclude Direct Mount)



Flexible
Installation

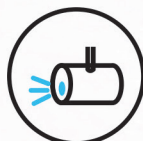

Sleek Spotlight
Design

3LCD PROJECTOR



EB-800F / 805F

Brightness 5,000 lm	Resolution 1080p	Contrast over 2,500,000 : 1
Light Source Life 20,000 hours (Normal), 30,000 hours (Extended)	Keystone ±3° (V) / ±3° (H)	Connectivity D-Sub 15Pin In x 2, Composite In RCA x 1 (Yellow), HDMI In x 3 (HDCP2.3), HDBaseT x 1 (HDCP2.3), D-Sub 15Pin Out x 1, HDMI Out x 1, Stereo Mini Jack In x 3, Stereo Mini Jack Out x 1, Rs-232C D-Sub 9Pin x 1, USB Type A x 2, USB Type B x 1, Wired Lan RJ45 x 1
Network Wireless Lan x 1 USB Type A	Power Consumption 366 W / 262 W	Weight Approx 9.4 Kg



Full HD Resolution



Ultra short-throw
130 inch @80,3 cm



Multi-PC Projection



PC free
USB memory

Ultra Short Throw Lamp Projectors

EB-685W



Brightness 3,500 lm	Resolution WXGA	Contrast 14,000:1
Light Source Life 5,000/10,000 hrs	Keystone ±3° (V) / ±3° (H)	Connectivity HDMI in x3, RCA x1 VGA in x2, VGA out x1 RS-232C x1, RJ45 x1 Stereo Mini Jack out x1 Stereo Mini Jack in x3 USB Type-A & Bx1 Microphone x1
Network Optional (ELPAP10)	Power Consumption 354W / 309W	Weight 5.7 kg



Ultra-Short
Throw



10,000 Hours
Lamp Life in Eco Mode



Multi-PC
Projection

3LCD PROJECTOR

Ultra Short Throw Lamp Projectors



**NEW
PRODUCT**

EB-760W

Brightness 4,100lm / 2,800lm	Resolution WXGA (1280 x 800)	Contrast over 2,500,000 : 1
Light Source Life Type : Laser Diode Life (Normal / Quiet / Extended) : 20,000 / 20,000 / 30,000 hrs	Keystone ±3°(V) / ±3°(H)	Connectivity HDMI Stereo Mini Jack USB Type A & B
Network Wired LAN RJ45 x 1 (100Mbps) Wireless Built-in and Optional (using ELPAP11)	Power Consumption Lamp On (Normal / Extended) 263W / 199W Standby (Network On / Off) 2.0W / 0.5W	Weight Approx 5.9 Kg



Ultra-Short Throw



20,000 Light Hours



Wireless Connection



Multi-PC Projection

EB-770F



**NEW
PRODUCT**

Brightness 4,100lm / 2,800lm	Resolution Full HD (1080p)	Contrast over 2,500,000 : 1
Light Source Life Type : Laser Diode Life (Normal / Quiet / Extended) : 20,000 / 20,000 / 30,000 hrs	Keystone ±3°(V) / ±3°(H)	Connectivity HDMI Stereo Mini Jack USB Type A & B
Network Wired LAN RJ45 x 1 (100Mbps) Wireless Built-in and Optional (using ELPAP11)	Power Consumption Lamp On (Normal / Extended) 263W / 199W Standby (Network On / Off) 2.0W / 0.5W	Weight Approx 5.9 Kg



Ultra-Short Throw



20,000 Light Hours



Wireless Connection



Multi-PC Projection



Full HD

3LCD PROJECTOR

EB-760Wi



NEW
PRODUCT

Brightness 4,100lm / 2,800lm	Resolution WXGA (1280 x 800)	Contrast over 2,500,000 : 1
Light Source Life Type : Laser Diode Life (Normal / Quiet / Extended) : 20,000 / 20,000 / 30,000 hrs	Keystone ±3°(V) / ±3°(H)	Connectivity HDMI Stereo Mini Jack USB Type A & B
Network Wired LAN RJ45 x 1 (100Mbps) Wireless Built-in and Optional (using ELPAP11)	Power Consumption Lamp On (Normal / Extended) 263W / 199W Standby (Network On / Off) 2.0W / 0.5W	Weight Approx 6.0 Kg



Ultra-Short Throw



20,000 Light Hours



Wireless Connection



Multi-PC Projection



Optional Finger Touch Interactive

EB-770Fi



NEW
PRODUCT

Brightness 4,100lm / 2,800lm	Resolution Full HD (1080p)	Contrast over 2,500,000 : 1
Light Source Life Type : Laser Diode Life (Normal / Quiet / Extended) : 20,000 / 20,000 / 30,000 hrs	Keystone ±3°(V) / ±3°(H)	Connectivity HDMI Stereo Mini Jack USB Type A & B
Network Wired LAN RJ45 x 1 (100Mbps) Wireless Built-in and Optional (using ELPAP11)	Power Consumption Lamp On (Normal / Extended) 263W / 199W Standby (Network On / Off) 2.0W / 0.5W	Weight Approx 6.0 Kg



Ultra-Short Throw



20,000 Light Hours



Wireless Connection



Multi-PC Projection



Full HD



Finger Touch Interactive

3LCD PROJECTOR

Ultra Short Throw Lamp Projectors

3LCD PROJECTOR



EB-695Wi Touch Interactive

Brightness 3,500 lm	Resolution WXGA	Contrast 14,000:1
Light Source Life 5,000/10,000 hrs	Keystone ±3° (V) / ±3° (H)	Connectivity HDMI in x3, RCA x1 VGA in x2, VGA out x1 RS-232C x1, RJ45 x1 Stereo Mini Jack out x1 Stereo Mini Jack in x3 Interactive Sync x1 USB Type-A & Bx1 Microphone x1
Network Optional (ELPAP10)	Power Consumption 354W / 309W	Weight 5.8 kg



Ultra-Short
Throw



10,000 Hours
Lamp Life in Eco Mode



Finger Touch
Interactive



Multi-PC
Projection

EB-1485Fi Touch Interactive



Brightness 5,000lm	Resolution 1080p	Contrast >2,500,000:1
Laser Light Source 20,000 hrs	Keystone ±3°(V) / ±3°(H)	Connectivity HDMI in x3 (HDCP2.3) HDBaseT x1 (HDCP2.3) HDMI out x1, RJ45 x1 VGA in x2, VGA out x1 Stereo Mini Jack in x3 Stereo Mini Jack out x1 RCA x1, RS-232C x1 Interactive Sync x1 Microphone x1, USB Type-A & Bx1
Network Built-in Support Screen Mirroring	Power Consumption 366W / 262W	Weight 9.3 kg



Ultra-Short
Throw



20,000 Light
Hours



Wireless
Connection



Multi-PC
Projection



Finger Touch
Interactive



Full HD

3LCD PROJECTOR

Large Venues

EB-PU1006W/ EB-PU1007W



Brightness 6.000 lm (PU1006W) 7.000 lm (PU1007W)	Resolution WUXGA	Contrast >2,500,000:1
Laser Source Life 20,000 hrs	Keystone ±45°(V) / ±30°(H)	Connectivity D-Sub 15Pin in x1, HDMI in x1, DVI-D in x1, HDBaseT, USB Type A x2 USB Type B x1, RS-232C x1, Stereo Mini Out x1, RJ45
Network Wireless Optional (ELPAP11)	Power Consumption 367W (PU1006W) 431W (PU1007W)	Weight 15.4 kg (PU1006W) 16.3 kg (PU1007W)



HDBaseT



Edge
Blending

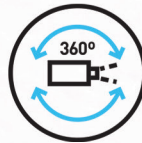

Flexible
Installation



NFC

EB-PU1008B/ EB-PU2010B



Brightness 8.500 lm (PU1008B) 10.000 lm (PU2010B)	Resolution WUXGA	Contrast >2,500,000:1
Laser Source Life 20,000 hrs	Keystone ±45°(V) / ±30°(H)	Connectivity D-Sub 15Pin in x1, HDMI in x1, DVI-D in x1, HDBaseT, USB Type A x2 USB Type B x1, RS-232C x1, Stereo Mini Out x1, RJ45, SDI x1 (for PU2010B)
Network Wireless Optional (ELPAP11)	Power Consumption 535W	Weight 16.3 kg (PU1008B) 16.8 kg (PU2010B)



HDBaseT



Edge
Blending



Flexible
Installation



NFC

3LCD PROJECTOR

Large Venues

3LCD PROJECTOR

EB-PU2213B



Brightness 13,000lm	Resolution WUXGA	Contrast >2,500,000:1
Laser Source Life 20,000 hrs	Keystone ±45°(V) / ±30°(H)	Connectivity HDMI in x1, SDI x1 HDBaseT x1 VGA in x1, VGA out x1 5BNC x1, DVI-D x1 RS-232C x1, RJ45 x1 Stereo Mini Jack in x3 Stereo Mini Jack out x1 USB Type-A & Bx1
Network Wireless optional (ELPAP10)	Power Consumption 908W / 597W	Weight 21.9 kg



HDBaseT



Flexible Installation



Edge Blending

EB-PU2216B



Brightness 16,000lm	Resolution WUXGA	Contrast >2,500,000:1
Laser Source Life 20,000 hrs	Keystone ±45°(V) / ±30°(H)	Connectivity HDMI in x1 HDBaseT x1 VGA in x1, VGA out x1 5BNC x1, DVI-D x1 RS-232C x1, RJ45 x1 Stereo Mini Jack in x3 Stereo Mini Jack out x1 USB Type-A & Bx1
Network Wireless optional (ELPAP10)	Power Consumption 1024W / 647W	Weight 22.3 kg



HDBaseT



Edge Blending

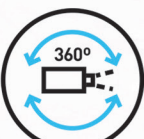

Flexible Installation

3LCD PROJECTOR

EB-PU2220B



Brightness 20,000lm	Resolution WUXGA	Contrast >2,500,000:1
Laser Source Life 20,000 hrs	Keystone ±44°(V) / ±30°(H)	Connectivity HDBaseT x1, RS-232C x1 VGA in x1, VGA out x1 BNC in x1, SDI in x1 Expansion Board ELPIF01 (HDMI in x1, DVI-D x1, DC-Out x1) Expansion Board ELPIF03 (Display port in x2) BNC out x1 RJ-45 x1 (etherCON) USB Type-A & B x1
Network Built-in	Power Consumption 1860W / 1123W	Weight 49.6 kg



HDBaseT

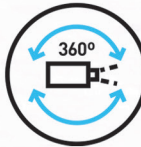

Flexible Installation



Edge Blending

EB-L30000UNL



Brightness 30,000lm	Resolution WUXGA	Contrast >2,500,000:1
Laser Source Life 20,000 hrs	Keystone ±45°(V) / ±30°(H)	Connectivity HDBaseT x1 (HDCP 2.2) VGA in x1, VGA out x1 SDI in x1, 5BNC x1 DVI-D x1 (Single link, HDCP 1.4) HDMI in x1 (HDCP 2.2) SDI out x1, RS-232C x1 Remote x1, RJ45 x1 USB Type-A & B x1
Network Optional	Power Consumption 2325W / 1511W	Weight 69.9 kg



HDBaseT

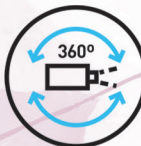

Flexible Installation



Edge Blending

3LCD PROJECTOR

Home Entertainment Projectors



EpiqVision **EF-11**

Brightness 1,000lm	Resolution Full HD (1080p)	Contrast > 2,500,000:1
Weight Approx 1.2 kg	Keystone ±34° (V) / ±40° (H)	Connectivity HDMI x1 (HDCP 1.4) Stereo Mini Jack Out x1 USB Type-A & Type-B x1



Auto Vertical Keystone



Miracast

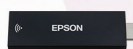

Android TV™ Dongle (ELPAP12)
sudah ada di dalam unit nya



EpiqVision **EF-12**

Brightness 1,000lm	Resolution Full HD (1080p)	Contrast > 2,500,000:1
Weight Approx 2.1 kg	Keystone ±34° (V) / ±40° (H)	Connectivity HDMI x1 (HDCP 1.4) Stereo Mini Jack Out x1 USB Type-A & Type-B x1



AndroidTV



Miracast

sound by **YAMAHA**

3LCD PROJECTOR

EH-TW6250



Brightness 2,800lm / 1,900lm	Resolution Full HD (1080P)	Contrast 35,000 : 1
Light Source Life Type Lamp: 200W UHE Lamp Life*1 Normal: 4,500 / Eco: 7,500 hours	Keystone ±30°(V) / ±30°(H)	Connectivity HDMI USB Type B
Network -	Power Consumption Lamp On (Normal/ Quiet, Extended) 301W / 231W Energy Saving 0.3W	Weight Approx 4.1 Kg



4K PRO-UHD



Auto Vertical Keystone



AndroidTV

EH-LS800B



Brightness 4,000lm / 2,000lm	Resolution 4K	Contrast Over 2,500,000:1
Light Source Life 20,000 hours (Normal / Eco)	Keystone -	Connectivity HDMI USB Type A
Network -	Power Consumption Lamp On (Normal/ Quiet, Extended) 335W / 210W Standby (Network On / Off) 2.0W / 0.4 W	Weight Approx 7.2 Kg



AndroidTV

sound by YAMAHA

Chromecast built-in

3LCD PROJECTOR

Home Entertainment

EpiqVision Ultra

EH-LS300B

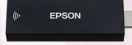

Android TV™ Dongle (ELPAP12)
sudah ada di dalam unit nya



Brightness 3,600lm	Resolution Full HD (1080p)	Contrast > 2,500,000:1
Laser Light Source 20,000 hrs	Keystone 8 point arc correction	Connectivity HDMI x2 (SMF, HDMI2=ARC) Audio Out (Bluetooth & Optical Out) USB Type-A x 1 USB Type-B Mini x1
Wireless Built-in	Power Consumption 278 W	Weight & Dimension Approx. 7.2 kg 400x467x133 mm



sound by YAMAHA

Chromecast built-in

EH-LS12000B



Brightness 2,700lm	Resolution 4K	Contrast > 2,500,000:1
Laser Light Source 20,000 hrs	Keystone ±30° (V) / ±30° (H)	Connectivity HDMI x 2 USB Type-A x 2 USB Type-B x 1 Stereo Mini Jack Out x 1
Network N/A	Power Consumption 302W/198W	Dimension Approx. 12.7kg 447 x 520 x 169 mm



4K



Lens Shift

3LCD PROJECTOR

EH-TW7000



Brightness 3,000lm	Resolution Full HD (1080p)	Contrast 40,000:1
Light Source Life 3,500 hrs / 5,000 hrs	Keystone ±30° (V) / ±30° (H)	Connectivity HDMI x 2 (HDCP 2.2) Stereo Mini Jack Out x 1 USB Type-A x 2 Type-B Mini x 1 Wireless ELPAP10 (Optional)
Max Screen Size 500 inch	Power Consumption 368W/280W	Weight & Dimension Approx 6.6 kg 410 x 310 x 157 mm



Vertical & Horizontal
Keystone Adjuster

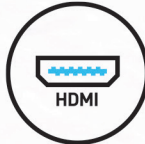

HDMI



EH-TW9400



Brightness 2,600lm	Resolution Full HD (1080p)	Contrast 1,200,000:1
Light Source Life 3,500 hrs / 5,000 hrs	Keystone ±30° (V)	Connectivity HDMI x 2 (HDCP 2.2) Stereo Mini Jack Out x 1 USB Type-A x 2 Type-B Mini x 1 Wireless ELPAP10 (Optional)
Max Screen Size 300 inch	Power Consumption 355W / 271W	Weight & Dimension Approx. 11.2 kg 520 x 170 x 450 mm



Lens Shift

3LCD PROJECTOR

Cross Over

3LCD PROJECTOR



CO-FH01

Brightness 3,000lm / 2,000lm	Resolution Full HD (1080P)	Contrast -
Light Source Life -	Keystone ±30°(V) / ±30°(H)	Connectivity HDMI USB Type A & B
Network Wireless (Optional)	Power Consumption 270W / 214W	Weight Approx 2.4 Kg

Full HD
1080p

CO-FH02



Brightness 3,000lm / 2,000lm	Resolution Full HD (1080P)	Contrast -
Light Source Life Type Lamp (Fixed), 188 W UHE Life (Normal/ Extended) 6,000 / 12,000 hours (Normal / ECO)	Keystone ±30°(V) / ±30°(H)	Connectivity USB Type A & B
Network -	Power Consumption 270W / 214W	Weight Approx 2.6 Kg

Full HD
1080p



Chromecast built-in

3LCD PROJECTOR

Wireless Presenter



ELPWP10

Ideal for small-group presentation, Selected Epson projectors offers an affordable and versatile wireless presentation system for offices.

[Contents: Wireless Dongle x2, ELPAP11 x1, Tray x1)



ELPWP20

- Cable-free collaboration Wireless presentation system for maximum ease of use
- Instant multi-screen sharing Display up to four devices simultaneously
- Display-agnostic Compatible with all displays with a HDMI input
- Compatibility with all major OSs Works with Windows, Mac, Android, iOS and Chromebooks
- Miracast built in For simple sharing on compatible devices

[Contents: Wireless Dongle x2, Base Station x1, Tray x1, IR Remote x1)



ELPWT01

- Power Consumption 5 VDC / 0.5 A
- Operating Temperature 0 to +40°C (Humidity of 20 to 80%, No condensation)
- Storage Temperature -20 to +70°C (Humidity of 0 to 95%, No condensation)
- Operating Altitude 0 to 3,000 m
- Dimensions Width 63.5 x Height 11 x Depth 175 mm (excluding USB conversion adapter)
- Weight Approx. 53 g

[Contents: Wireless Dongle x1)