



EPSON

BE COOL AND
SAVE THE WORLD



20 PRODUCT 23 CATALOGUE

SEIZE
23
THE CHANCE

TABLE OF CONTENT

- 03 INTRODUCTION
- 06 OUR SERVICES
- 14 OUR PARTNER
- 24 INKTANK PRINTER
- 35 PORTABLE PRINTER
- 44 INK CONSUMABLE
- 46 BUSINESS INKJET PRINTER
- 70 COMMERCIAL & INDUSTRIAL PRINTER
- 94 LASER PRINTER
- 100 BUSINESS & PHOTO SCANNER
- 116 3LCD PROJECTOR
- 146 TM PRINTER
- 158 LABEL INKJET PRINTER
- 166 LABEL PRINTER
- 174 DISC PUBLISHER
- 178 DOT MATRIX PRINTER
- 190 ROBOT SOLUTION



EPSON INNOVATES TO EXCEED

Selebrasi Ulang Tahun Epson Indonesia: Rayakan Pencapaian dan Rasa Syukur

Saat kami menandai satu tahun baru perjalanan Epson Indonesia, ini adalah kesempatan penting untuk merefleksikan pencapaian kami dan mengungkapkan rasa terima kasih yang tulus kepada para karyawan, mitra, dan pelanggan kami yang luar biasa selama 23 Tahun terakhir.

Dalam perjalanan kesuksesan kami, karyawan kami berperan besar sebagai aset yang berharga. Hari ini, kami menghormati dedikasi dan kontribusi mereka yang luar biasa. Pencapaian mereka adalah wujud dari pencapaian kami selama ini.

Kepada para pelanggan setia kami, kepercayaan Anda mendorong inovasi kami. Kami mengucapkan terima kasih yang sebesar-besarnya atas kemitraan Anda yang berkelanjutan. Perjalanan ini tidak akan lengkap tanpa Anda. Komitmen kami lebih dari sekadar bisnis. Sebagai bagian dari tanggung jawab perusahaan, kami secara aktif menjaga hubungan bisnis ini dengan mitra, memberikan kepercayaan serta rasa persatuan dan tujuan. Kami telah menempuh perjalanan panjang, mencapai berbagai pencapaian yang mendefinisikan kemajuan kami. Namun, kami tidak akan berhenti di sini. Visi kami untuk masa depan lebih cerah dan lebih menantang dari sebelumnya. Bersama-sama, kita akan terus mencapai tingkat yang lebih tinggi.

Kepada seluruh karyawan, mitra bisnis, dan pemangku kepentingan, kami mengundang Anda untuk bergabung bersama kami dalam merayakan perjalanan ini. Bersama-sama, kita akan menyelenggarakan berbagai acara, berbagi cerita, dan terhubung dengan khalayak yang lebih luas, untuk memperkuat komitmen kita bersama terhadap keunggulan.

Seiring kita memasuki tahun berikutnya, mari kita terus terinspirasi dari masa lalu kita, fokus pada masa depan kita, dan berterima kasih kepada orang-orang yang membuat semuanya menjadi nyata.

Stay safe, stay healthy, and stay productive.

Terima kasih!

Ng Ngee Khiong
Managing Director
of Epson Indonesia



EPSON INDONESIA COVERAGE AREA



28 BIG AUTHORISED
SERVICE PARTNER

199 SMALL AUTHORISED
SERVICE PARTNER



10 EPSON
NATION-WIDE
DISTRIBUTOR

135 EPSON
AUTHORISED
MASTER DEALER

804 EPSON
AUTHORISED
DEALER

EPSON BIG ASP

City	Address	Phone
Ambon	Jl. Diponegoro No.37 (Samping Bank Syariah Indonesia) Kel.Alhusen, Kec.Sirimau - Ambon 97127	1-500-766
Bandung	Jl. Cihampelas No. 48 A Bandung Jawa Barat 40116	1-500-766
Banjarmasin	Jl. Gatot Soebroto No. 153 Banjarmasin - Kalsel 70235	1-500-766
Batam	Jl. Komplek Bumi Indah blok V No. 14, Kel. Lubuk Baja Kota, Kec. Lubuk Baja, Kota Batam, Prov. Kepulauan Riau 29444	1-500-766
Bogor	Jl. Raya Pajajaran Ruko No.15B Bantarjati, Bogor - Jawa Barat 16153	1-500-766
Cikarang	Ruko Metro Boulevard B1 Jababeka cikarang - Jawa Barat 17530	1-500-766
Cirebon	Ruko Flamboyan, Jl. Pemuda Raya No. 36 Sunyaragi, Kesambi, Cirebon, Jawa Barat 45132	1-500-766
Denpasar	Jl. Mahendradata No. 18B, Padangsambian, Denpasar - Bali 80117	1-500-766
Jakarta	CIBIS Business Park Lot 304, Jalan TB Simatupang No.2, Jakarta Selatan - DKI Jakarta 12560	1-500-766
Jakarta	Ruko Mall Mangga Dua No. 48 Jl. Arteri Mangga Dua, Jakarta Pusat - DKI Jakarta 14420	1-500-766
Jakarta	Wisma Keiai Lt. 1 Jl. Jenderal Sudirman Kav. 3 Jakarta Pusat - Dki Jakarta 10220	1-500-766
Jember	Jl. Panglima Besar Sudirman Ruko No.1D Jember-Jawa Timur (Depan Balai Penelitian & Pengolahan Kakao) 68118	1-500-766
Madiun	Jl. Diponegoro No.56A, Kec Kartoharjo, Madiun - Jawa Timur 63119	1-500-766
Makassar	Jl. Opu Daeng Risadju No. 3A, Kunjung Mae, Mariso, Makassar - Sulsel 90125	1-500-766
Manado	Kawasan Megamas, Jl Piere Tendean Blok D No.4 Manado Sulawesi Utara 95111	1-500-766
Medan	Jl. Bambu II Komplek Graha Niaga Nomor A3B/A4, Medan - Sumut 20235	1-500-766
Palembang	Jl. H.M Rasyid Nawawi No. 249 Kelurahan 9 Ilir Palembang Sumatra Selatan 30113	1-500-766
Palu	Jl. Juanda No.58 - Palu 94111	1-500-766
Pekanbaru	Jl. Tuanku Tambusai No. 459 A Kel. Tangkerang Barat Kec Marpoyan Damai Pekanbaru, Riau 28282	1-500-766
Pontianak	Komplek Centra Bisnis Ayani Mega Mall Blok G.33, Jl. Ahmad Yani - Pontianak, Kalimantan Barat 78113	1-500-766
Purwokerto	Jl Jendral Sudirman Ruko PJK A No.4, Kranji, Purwokerto - Jawa Tengah 53116	1-500-766
Samarinda	Jl. Kh. Wahid Hasyim (M. Yamin) Kel. Sempaja Selatan, Kec. Samarinda Utara - Samarinda, Kaltim 75119	1-500-766
Semarang	Komplek Ruko Metro Plaza Blok C20 Jl. Mt Haryono No. 970 Semarang -Jawa Tengah 50242	1-500-766
Serang	Jl. Ahmad Yani No.45C, Serang - Banten 42117	1-500-766
Surabaya	Jl. Raya Gubeng No. 62, Surabaya - Jatim	1-500-766
Surabaya Barat	Jl. H.Abdul Wahab Saimin, Ruko Villa Bukit Mas Rm-11 Rt.01 Rw.07 Kel. Dukuh Pakis Kec. Dukuh Pakis, Surabaya - 60225	1-500-766
Tangerang	Ruko Melati Mas Square Blok A2 No.17 Serpong Tangerang Selatan Banten 15310	1-500-766
Yogyakarta	Yap Square, Blok A No. 6 Jl. C Simanjutak No. 2, Yogyakarta - DIY 55233	1-500-766

EPSON CUSTOMER CARE.

Feel free to contact us

 1-500-766



Chat (Whatsapp, SMS)



0812-12-37766

EPSON



**JAM OPERASIONAL EPSON CUSTOMER CARE DI
SENIN – SABTU , 07:00 – 19:00 WIB**

customer.care@ein.epson.co.id

Visit Us on       [epsonindonesia](https://www.epsonindonesia.com)  www.epson.co.id

EPSON AUTHORISED SERVICE PARTNER

City	Name	Address	Phone
Abepura	Dunia Computer	Jl. Raya Abepura, Samping Pengadilan Negri Abepura - Papua	0967-5185007 99351
Ambon	HI-Tech Computer	Jl. Imam Bonjol No. 12, Ambon - Maluku	97124 0911- 343434
Balikpapan	Widya Wisesa	Komp. Pantai Mas Permai Blok B No.14, Jl. Jend. Sudirman, Balikpapan-Kaltim	76100 62 542 730439
Banda Aceh	Angkasa Putera Abadi	Jl. T. Panglima Polem no. 141 Banda Aceh	23122-NAD 0651-636026
Bandar Lampung	CV. Rai Inkpart Computer	Jl. Diponegoro No. 121F, Sumur Batu - Teluk Betung - Lampung	35214 0813 69025565
	Mahirnet Servisindo	Jl. Kartini No. 134, Tanjung Karang, Bandar-Lampung. Lampung	35116 62 721 250456; 62 721 250486
Bandung	MIP Bandung	Ruko ITC Kosambi Blok D1, Jl. Baranangsiang Kel. Kebo Pisang Kec. Sumur Bandung, Kota Bandung - Jawa Barat	40112 022-5427034 / 02254413777
	CN Computer	Jl. Taman Kopo Indah 2 Ruko 1A No. 37 Bandung - Jawa Barat	40262 022-20597937
	PT. Teknika Sarana Gardian (Bandung)	Jl. Semar No.1 Kelurahan Arjuna, Kec Cicendo, Kota Bandung, Jawa Barat	40172
Banjarbaru	CV. Twincom	Jl. Panglima Batur Timur Rt02 No.06 (Deretan Rs. Mawar) Banjarbaru	70711 08115138800
Banjarmasin	Berlin Komputer	Jl. Kol Sugiono No.19, Banjarmasin. Kalimantan-Selatan	70233 62 511 3260228; 62 511 410750
	CV. Multi Prima	Jl. Veteran No. 8-9 Rt 07/01 Kel. Kuripan Banjarmasin - Kalsel	70236 0511-3277154
Barabai	CV Hidayah Technology	Jl. Ulama RT. 6 No. 23 Barabai Kab. Hulu Sungai Tengah, Kalimantan Selatan	71314 0517-41051
Batam	Muracom	Ruko Rafflesia Blok C No. 6 Batam Centre - Batam Kepri	29461 0778-472518/ 0778-472515/ 0778-7320615
Batulicin	CV Smart Jaya Tech	Jl. Pesantren No. 71 Batulicin, Tanah Bumbu, Kalimantan Selatan	72171 081349559909
Baturaja	CV. Jasu sri Wahyu (Digicom)	Jl. Jend Ahmad Yani No.14B, Air Karang, Desa Tanjung Baru, Baturaja, Ogan Komering Ulu, Sumatera Selatan	32121 0735-326634
Bekasi	XYZ-Go Print	Ruko Suncity Squire Blok A-21 Jl.Mayor Madmuin Hasibuan Margajaya Bekasi Selatan Kota Bekasi	17141 081398362722
Bengkayang	CV. Harindo	Jl. Sanggau Ledo No. 24 Rt.04/Rw.02 SeboPET, Bengkayang - Kalbar	79284 0562-4442340
Bengkulu	CV. Biru Teknologi Multimedia	Jl. Mt Haryono No 19B Kampung Bali - Bengkulu	38114 0736-28548
Bima	Sentral Muslim	Jl. Soekarno Hatta, No.77, Kota Bima, Ntb	84111 0374-646806
Bireuen	CV. Putra Solusindo Computer	Jl Medan B Aceh No 15 Bireuen - Aceh	24211 0644-22709
Bitung	Smart Computer	Jl. H. V. Worang No.2, Kel.Kadoodan Kec. Madidir, Bitung - Sulut	95513 0438-30805
Blangkejeren	CV. Mulia	Jl. Pasar Lama No. 156 Kota Blankejeren Kec Blankejeren Kab Gayo Luwes Aceh	24655 081286132992
Bogor	PT. Gerai Servis Indonesia	Ruko Taman Yasmin Sektor VI No. 138 Jl. KHR abd. Bin M Nuh Bogor	16113 0251-7592054
Bojonegoro	Hitech Bojonegoro	Jl. Teuku Umar No 52 Bojonegoro	62111 085231167031
Bondowoso	Prince Computer	Jl. Kh.Agus Salim 101 Blindungan Bondowoso	Jatim 68212 0332-5635057 / 433358
Bone	Surya Indah Computer	Jl. Sukawati No.88, Bone, Sulawesi Selatan	92713 0481-2921039
Bontang	Ganeka Komputer	Jl. Bhayangkara No. 21 Bontang Kalimantan Timur	75311 054824542
Boyalali	XP Computer	Jl. Merbabu 18 Boyolali Jateng -	57311 0276-320044
Bukit Tinggi	Central Multi Computer	Jl. Raya Bukittinggi No. 120 Bukittinggi, Komp. Ruko Jambu Air Permai No.120, Sumbang	26181 0752-7003688; 0752-625876
Bulukumba	CV Media Computer	Jl. Cendana No.15, Bulukumba, Sulawesi Selatan	92518 0431-2587988
Ciamis	MicomP	Jl. Kh. A. Dahlan No. 5 Ciamis - Jawa Barat	46211 0265-772636
Cianjur	CV. Mitra Jaya Computindo (Digicom)	Jl. Moch Ali No. 62 Cianjur	43214 0263-260789 / 087778888909
Cibinong	PT. Gerai Servis Indonesia	Jl. Tegar Beriman No. 1 Blok A35 Pertokoan Cibinong City Center - Cibinong	16915 021-29335280
Cibubur	PT. Sukses Komputindo Abadi	Komplek Ruko Citra Gran, Jl. Alternatif Cibubur No.23, RT.001/RW.011, Jatikarya, Kec. Jatisampurna, Kota Bekasi, Jawa Barat	17435 021-8452024
Cilegon	Star Media Tehnik	Jl. Kepodang No. 69 Kav. Blok F Cilegon - Banten	42415 0812 1234 9045 / 087777101145

EPSON AUTHORISED SERVICE PARTNER

City	Name	Address	Phone
Cimahi	CV. Niscaya Berkah	Jl. Jendral Amir Mahmud No. 603 Rt 02/010 Kel. Setiamanah Kec. Cimahi, Cimahi Jawa Barat 40524	022 665 2991
Ciputat	Macindo Pusat (Mitra Adiyasa Cemerlang)	Jl. Otista Raya, Rt 01/010 No 53G, Ciputat Tangerang Selatan 15411	021 2274 4044
Cirebon	CV. Mitra Indexindo Pratama	Jl. Basalamah No.59E (Panjunan), Lemahwungkuk, Kota Cirebon, Jawa Barat, 45112	0231-211673; 0231-245568
Demak	Prima Komputer	Jl. Demak-Kudus No. 83, Tanubayan - Demak, Jateng - 59511	085292114696
Denpasar	MIP Denpasar	Jl. Raya Sesetan 53A, Ruko Sukma Cendana, Denpasar - Bali 80114	087875904915
	Rumah Printer	Gedung RTC Lt.2 No. E5, Jl.Diponegoro No. 136 Dauh Puri Klod, Denpasar 80232	081908233350
Depok	MBI Depok	Komplek Ruko Permata Depok Regancy Blok A No.2 Kec. Ratu Jaya, kota Depok, Jawa Barat	021-77810347/ 0817-70883444
Dumai	Maestro Komputer	Jl. P. Diponegoro No. 211 Dumai - Riau 28812	0823 8223 1199
Duri	Computer City	Jl. Jend Sudirman No.228 D Duri - Riau	0765- 598008/0765- 598006
Garut	Central Computer	Jl. Cimanuk 273 Garut - Jawa Barat 44118	0262-235420
Gorontalo	Square Computer	Jl. S Parman No. 36A Kel. Biawao, Gorontalo Sulawesi Utara- 96111	082188007111
Gunung Sitoli Nias	D. Com	Jl. Diponegoro No. 136, Gunung Sitoli - Nias, Sumut 22815	085262277088
Indramayu	Personal Komputer	Jl. MT. Haryono No. 2B Sindang Indramayu Jawa Barat 45221	087873735050
Jakarta	PT Sentra Inovasi Solusindo	Jl. Agung Timur 4 Blok 01 No. 42 - 43 Sunter Jaya Jakarta Utara 14350	0216517216 / 0812 1868 6100
	MIP Cideng	Cideng Barat No. 47 G2 Rt/ Rw 009/04 Kelurahan Cideng Kecamatan Gambir Jakarta Pusat- 10150	021-22632749
	PT. Tekno Mandiri Abadi	Harco Mangga Dua Lt. 3, Blok B, No.51 Jakarta Pusat	081393714477
	PT. Teknika Sarana Gardian (Jakarta)	Jl.RS Fatmawati Rukan Golden Fatmawati (D'best) Blok J No.26, Jakarta Selatan 12560	021-75914343, 021-29042911
	MIP Warung Jati	Jl. Warung Jati Barat No.41B, Rt.8/Rw.5, Kalibata, Pancoran, Kota Jakarta Selatan, Daerah Khusus Ibukota Jakarta 12740	021-7946881
	PT. HSN Tech Indonesia (Fatmawati)	Ruko Itc Fatmawati Unit No. 7 Jl. Rs Fatmawati No. 39 Jakarta Selatan 12150	021-27513202
	PT. Faasri Utama Sakti	Jl. Raya Gading Indah No. 8 Kav. A4 Gading Permai, Jakarta-14240 (Belakang Mall La Piazza Kelapa Gading)	021-45844088
	Reksa Sekawan	Itc Permata Hijau Lt 3 Blok C11 No. 19 Jl.Ir. Soepeno Jakarta Selatan - Jakarta 12210	021-53663961
	PT. Berkah Tumbuh Bersama Indonesia (Bertubi)	Kompleks Ruko Mutiara Taman Palem, Blok C10 No. 53 Jl. Outer Ring Road, Kel. Cengkareng Timur, Kec. Cengkareng Jakarta Barat 11730	085693572247
	Jambi	CV. Eleven Jambi	Jl. Gatot Subroto No 10 Jambi 36134
Jayapura	CV. Master Computer	Jl. Percetakan Negara No. 94A, Jayapura - Papua 99111	0967-533588
Jember	Bitcom	P. Sudirman No. 58 Jember - Jatim 68118	0331-481822
Kabanjahe	CV. Mitra Computindo (d/h Era Baru Computer)	Jl. Padang Mas II No. 12, Kabanjahe Sumatra Utara 22115	0628-9032078
Karawang	Megatama Computindo	Jl. Arief Rahman Hakim No. 10B Karawang 41311	0267-8409202 / 08118499886
Kebumen	Utama Computer Kebumen	Jl. HM Sarbini No. 66 Kebumen 54316	0287382930
Kediri	Sumber Tehnik Kediri	Jl. Joyoboyo 25E Banjaran, Kota Kediri Jawa Timur 64129	0354-688880
Kendari	Mentari Komputer	Jl. Dr Sam Ratulangi No.14 Mandonga kendari 93717	085242245196
Ketapang	Metro Computer	Jl. R. Suprpto No. 88, Ketapang, Kal-Bar 78812	0534-34355; 0534-35900
Kisaran	CV. F3i	Jl. Cokroaminoto No. 147 Kisaran Sumut 21214	0623 - 43647
Kotamobagu	Carper Computer	Jl. Veteran No. 21 Kel. Motoboi Kecil, Kotamobagu Komp. Manggala Sport Hall - Sulut 95711	0434-23338
Kuningan	Zigma Comp	Jl. Re. Martadinata 33 Cijoho Kuningan - 45513	0232-874608
Kupang	Duta Multi Computer	Ruko Lontar Permai Jl. Raya Wolter Monginsidi III Blok A 21 Kupang - NTT 85111	0380-828333/ 08308441428 / 08113829998
Lamandau	My Computer dan Elektronik	Jl. Tjilik Riwut Rt. 02A Samping SDN Nanga Bulik Lamandau Kalimantan Tengah 74162	081220243666
Lampung	PT. HSN Tech Indonesia (Lampung)	Jl. Teuku Umar No. 157 Kedaton Lampung 35132	0721-705430

EPSON AUTHORISED SERVICE PARTNER

City	Name	Address	Phone
Lubuk Linggau	Sigma Komputer	Jl. Yos Sudarso No. 19, Lubuk Linggau, Sumsel 31621	0733-324828
Lumajang	Lab Persada Computer	Jl. Wijaya Kusuma No. 11 Lumajang Jawa Timur 67315	0334-811411 / 0334-888221
Luwuk Banggai	Mitra Mandiri (Jaya Raya Com)	Jl. Sam Ratulangi No.141 Luwuk Banggai -Sulteng 94712	0461-21225
Madiun	Astro Madiun	Jl. Hos Cokroaminoto 53, Kejuron, Taman, Madiun - Jatim 63132	0351-472799
	Maju Hardware	Plaza Matahari Jl. Pahlawan No.38-40 Madiun - Jawa Timur 63121	0351-481644
Magelang	Mikro Magelang	Jl. Tidar 24, Magelang Jawa Tengah 59214	0293 363453
Majalengka	Gemilang Prakarsa (Alfanet)	Jl. Kh. Abdul Halim No. 176 Majalengka - Jawa Barat 45418	0233-8285500
Makassar	Ariel Computer	Jl. G. Latimojong 163 A, Makassar. Sulawesi-Selatan 90141	0411 3610310
	MIP Makassar	Jl. AP. Pettarani Kompleks Pettarani Center Blok B12 Bua Kana, Rappocini, Kota Makassar Sulsel 90233	0411 - 4669162
	Makassar Print	Mtc Karebosi Lt.2 Blok P3A-B, Jl. Jend. A. Yani No. 47, Makassar - Sulsel 90174	0411-2558484
Malang	Angkasa Computer Center	Jl. T.G.P No. 1, Malang. Jawa-Timur 65112	0341 351000/ 0341 323222
	PT. Teknika Sarana Gardian (Malang)	Jl.Terusan Sulfat Kav.2 No.69 Pandanwangi, Blimbing Malang 65139	085109335522
Mamuju	Mahadewa Computer	Jl. Jend. Sudirman Kav 10 No. 2, Mamuju - Sulawesi Barat 91512	085100723588
Manado	PT. Master Media	Ruko Megasmart 5 No.11 Boulevard Jl. Pierre Tendean Manado - Sulut 95111	0431-8821658
	Intertech Computer	Jl. Aipda K.S Tubun No. 25 Istiql Manado, Sulawesi Utara 95121	0431 863560
Manokwari	CV. Galerindo Komputama (Itech Manokwari)	Jl. Drs. Esau Sesa Wosi, Manokwari (Samping X Advertising) 98312	'081342012387
Mataram	Revayah Mataram	Jl. Sriwijaya, Pertokoan Sriwijaya No 9, (Depan Kura-Kura, Samping Indomart) Mataram - Lombok 83127	0878-6580- 6395
Medan	MIP Medan	Jl. Prof. HM. Yamin Sh No.448, Sei Kera Hulu, Kec. Medan Perjuangan, Kota Medan, Sumatera Utara 20222	061-4553195
	Golden Dragon	Jl. Veteran No. 14D / 28 Medan - Sumut 20231	061-4567822; 061-77273158
Merauke	Padi Komputer	Jl. Parakomando No: 99 Merauke - Papua 99614	0971 - 322688
Metro	Zona Computer	Jl. Ah Nasution No. 67 A Kota Metro Lampung 34112	0725-48685
Meulaboh	CV. Multi Media	Jl. Manekro No. 38 Jurong V Gampong Kec Johan Pahlawan Meulaboh Aceh 23614	06557551722
Muara Bungo	PT. Mitra Komputer Bungo	Jl. Jend Sudirman KM 0 No. 67 Rt.09/02, (Sebelah Danamon & Rm. Jasum), Pasar Muara Bungo, Jambi 37212	0747-7331074
Nanga Pinoh	Komdisc Store.com	Jl. Juang Km. 2 No.77, Desa Tj. Niaga, Nanga Pinoh - Kalbar 79672	0568-22888
Pacitan	Surya Abadi Computer	Jl. Imam Bonjol No.34 Pacitan Jawa Timur 63512	0357-884534
Padang	Sinar Mulia Padang	Jl Belakang Tangsi II No 3A Padang - 25118. (Service)	62 751 28861; 0751-28841
	CV. Maxindo	Jl. Kp. Nias V No. 7, (Belakang Pondok), Padang - Sumbar 25211	0751-38837; 0751-39119
	PT. HSN Tech Indonesia (Padang)	Jl Veteran No. 75C Padang 25117	075-1891116
Palangkaraya	Abadi Mitra Computer II	Jl. Galaksi Raya No. 7D, Palangkaraya - Kalteng 73111	0536-3238613
Palembang	Multikom	Jl. Lingkaran I No. 22, Palembang. Sumatera-Selatan 30113	0711 316008 / 0711 358205
Palopo	Aruna Multi Computer	Jl. Andi Kambo No. 19C Palopo - Sulsel 91921	0471-326461
Palu	Sara Com	Jl. S. Parman No. 61 Palu 94111	0451-4706614 / 085397751745
Pangkalan Bun	Artha Computer	Jl. Kawitan I Pangkalan Bun - Kalteng 74112	0532-24567
Parigi	CV. Libra Com	Jl. Trans Sulawesi Kel Kampal Parigi Sulawesi Tengah 94471	085398852011 / 0811454530
Pasuruan	Aneka Sarana Computer	Jl. R.A. Kartini No. 12 Bangilan, Panggungrejo, Pasuruan - Jawa Timur 67114	0343-423739
Pati	Pati It Klinik	Jl. Kolonel Sunandar- Pati (Utara Stadion Joyokusumo Pati) 59163	085740526029
Payakumbuh	Indocomputer Payakumbuh	Jl. Soekarno Hatta No. 39, Payakumbuh Sumbar (Depan Rumah Bersatin Annisa) 26225	0752-93705

EPSON AUTHORISED SERVICE PARTNER

City	Name	Address	Phone
Pekalongan	Mitra Komputer	Jl. H.A. Salim No. 63 Pekalongan 51127	0285-435431
Pekanbaru	Multi Media Computer	Jl. Prof Moh Yamin Sh No 55B Pekanbaru. Riau 28155	0761-46814/ 0761-856856
	Dwiwira	Jl. Dr Setia Budhi No. 107A Pekanbaru 28144 - Riau	0761-25977 / 0761- 25189/0761- 28891
Pemalang	CV. Irama Putra Mandiri	Jl. Melati No. 09 Rt 005/012 Kel Palutan, Kec Pemalang Jawa Tengah 52311	081129975
Pematang Siantar	Asia Komputindo	Jl. Kartini No. 32E Pematang Siantar Sumut 21112	0622-5890388
Pontianak	Metro Computer	Jl. Gajah Mada No.87, Pontianak. Kalimantan-Barat 78123	0561- 742555/0561- 741610
	Datacom	Jl. Setiabudi No. 97A, Pontianak. Kalimantan-Barat 78122	62 561 739571; 62 561 748905
	CV. Irama Komputer	Jl. Prof M. Yamin RT 001/RW 001 Kel Kotabaru Kec. Pontianak Selatan Kalimantan Barat 78121	0811-5655-553
Probolinggo	Ridicomp	Jl. Gatot Subroto (Depan Polsek Katobu) Kota Raha, Probolinggo -Jawa Timur 67217	0335-425858
	UD. Global Tech&Service	Jl. Mastrip 177 Kanigara Probolinggo Jatim- 67213	0335-434009 / 430447
Purwakarta	Putri Komputer	Jl. Ibrahim Singadilaga No. 64 Koncara - Purwakarta 41112	02648301614
Purwokerto	Indo Komputer	Ruko Satria Plaza Blok A No 1, Jl. Jend Sudirman, Purwokerto. Jawa Tengah 53114	0281-632500
	Tripio Komputer	Jl. Dr. Angka No. 85 A, Purwokerto-Jawa Tengah 53114	0281-621908 / 081215428888
Putusibau	Mitra Computer	Jl. Komyor Ruko No. 2 Putusibau Kalbar 78711	0567-22835
Raha	RC Computer	Jl. Gatot Subroto (Depan Polsek Katobu) Kota Raha, Wamponiki, Katobu, Muna - Sulawesi Tenggara 93613	0852 41747222
Salatiga	Aston System	Jl. Imam Bonjol No.28 Salatiga	0298-326431
Samarinda	LiData Comp	Jl. Lambung Mangkurat 40, Samarinda. Kalimantan-Timur 75117	0541-739127 / 0541-736127 / 0541-7773002
Sampit	My Digital (CV. Teknologi Dunia Satu Keluarga)	Jl. Kapten Mulyono No.98A, Sampit - Kalteng 74323	0531-31335 / 085257667864
Sanggatta	Global Computer	Jl. Karya Etam No. 152B Sangatta Utara, Kutai Timur, Kalimantan Timur 75611	0549-2024148
Sanggau	Zoom Computer	Jl. Jend Sudirman No.19, Sanggau Kalbar 78512	0564-22181
Sekadau	CV. Neo Computer	Jl. Merdeka Timur Km. 02 Sekadau - Kalbar 79582	0564-2021012
Semarang	Compumart	Jl Singosari Raya No. 9 Semarang 50242	024 831 1199
	MIP Semarang	Jl. Indra Prasta No. 76B, Semarang - 50131	024-76433197
Serpong	PT. Kreatif Sinergi Teknologi	Jl. Raya Rawa Buntu No.2 (Jl. Dahlia), Kel. Rawa buntu, Kec Serpong, Kode Pos 15318	0858 9710 1388
Sibolga	CV. Modern Computer	Jl. Imam Bonjol No. 107 Sibolga Tapanuli Tengah 22522	0631-27777 - 27888
Sidikalang	UD. Mitra Computer	Jl. S.M Raja No. 19 Kel Batang Beruh Kec Sidikalang Sumatra Utara 22212	0627424150
Sidoarjo	Matahari Makmur Computer	Jl. Diponegoro No. 78, Sidoarjo - Jatim 61213	031-8069233
Singaraja	CV. Indotech	Jl. Ahmad Yani No. 55 Singaraja Kel Kaliuntu Kec Buleleng Bali 81114	0362-28123
Singkawang	CV. Central Computer	Jl. Yohana Godang No. F9 Rt. 26/07 Melayu - Sigkawang Barat Kalbar 79112	0562-638832
Sinjai	CV. Amalia Utama Computer	Jl. Manimpahoi No. 1 Kel Bongki, Kec Sinjai Utara, Sulawesi Selatan 92615	'085225393335
Sintang	CV. Gloria Komputer	Jl. Wirapati Rt 001/001 Kel Kapuas Kanan Hulu, Sintang Kalimantan Barat 78614	085245872371
Situbondo	Sigit Komputer	Jl. Cempaka No. 18B Patokan Situbondo Jawa Timur 68312	0338673408
Subang	MS Computer	Jl. Arief Rahman Hakim No. 35 Subang - Jawa Barat 41213	0260-416126 / 7707733
Subulussalam	Esa Computer	Jl. Nyak Adam Kamil Dusun Pemancar Kel Penanggalan Barat, Kec. Penanggalan Kota Subulussalam Prov Aceh 24782	081269396969
Sudimara	PT. Tiga Samudera Adiperkasa	Komplek Ruko Kuta - Ubud Village Block A-7 Jl. Hos Cokroaminoto, Sudimara Timur Tangerang Selatan 15151	021-2905 2864
Sukadana	KS Computer	Jl. Tanjung Pura Desa Sutera Kec Sukadana Kab Kayong Utara Kalimantan Barat 78852	082155505552

EPSON AUTHORISED SERVICE PARTNER

City	Name	Address	Phone
Sukamara	Sahabat Komputer dan Elektronik	Jl. Tjilik Riwut No. 30 Sukamara Kalimantan Tengah 74172	085252561656
Sumedang	CV. Semesta Komputama (Itstore)	Plaza Asia Sumedang GF 19-20 Jl. Prabu Gajah Agung No. 5 Sumedang Jawa Barat 45621	082118096595
Surabaya	PT Amtek Perkasa Internasional	Jl. Sidoserma Airdas Kav A9 Surabaya- Jawa Timur 60239	08113313344
	Abadi Cipta Komputer	Jl. Manyar Rejo 17 Menur Pumpungan, Sukolilo, Surabaya - Jatim 60118	031 5921236 - 37
	MIP Surabaya	Ruko Sentra Fortuna, Jl. Jaksa Agung Suprpto 39 Kav. 20, Ketabang, Kec Genteng Surabaya 60272	031-71758865; 031-5355460
Surakarta	PT. HSN Tech Indonesia (Surabaya)	Jl. Kusuma Bangsa No. 25D Kel Ketabang Kec Genteng Surabaya 60272	0231-99299907
	Prima Mitra Abadi	Jl. Veteran No. 205 Solo - Jateng 57155	0271-645350 / 0271-664847
Tambun	CV. Manxi Image Perkasa	Jl. Mh Tamrin No 67 Manahan Solo - Jateng (Depan Kantor Pos) 57143	0271 7462052 / 085100092986
	CV. Matrix Mikro Computer	Ruko Tambun City, RH No. 09, Jl. Sultan Hasanuddin No. 60-80, Tambun - Bekasi Jawa Barat 17510	021-22137718
Tanjung Balai Asahan	Star Computer	Jl. Sudirman No. 151 Tj. Balai Asahan Sumatra Utara 21332	0623-92060
Tanjung Morawa	Family Computer	Jl. Perintis Kemerdekaan No. 9, Tanjung Morawa B, Deli Serdang - Sumut 20362	061-7940358
Tanjung Pandan	DNP Computer	Jl. Telex Rt 06/02 Air Merbabu - Tanjung Pandan Belitung 33411	0719-9223528
Tanjung Pinang	Force Computer	Jl. Raja Ali Haji No. 10, Tj. Pinang - Kepri 29124	0771-26888; 0771-314354
Tarakan	Plus-Plus Computer	Ruko Gusher Block C-10 Jl. Gajah Mada Tarakan - Kaltara 77111	0551-36120 / 0551-5542796
Tasikmalaya	Planet Computer	Jl. Selakaso No. 4, Tasikmalaya Jawa Barat 46121	0265 332223
Tegal	CV Indo Computer Tegal	Jl. Mayjen Sutoyo 14 Tegal 52125	0283-343500
	Graha Computer	Jl. AR Hakim No. 167, Desa/Kelurahan Mangkukusuman, Kec Tegal Timur, Kota Tegal, Provinsi Jawa Tengah	'0283350140
Tenggarong	CV. Sentral Solusi Sejahtera	Jl. Kartini No. 22 Rt. 18, Tenggarong- Kutai Kartanegara Kaltim 75512	0541-665938
Ternate	PT. Datagrid Maestro Tekno	Jl. Raya Jati No. 17, Rt 03/02 Kel. Jati Ternate Selatan - Maluku Utara 97716	0921-6205567 / 081244029788
Timika	CV. Ithsan Infotika	Jl. Bhayangkara No. 39 Koperapoka, Timika - Papua 99910	0852 44523545
Tj. Redeb Berau	G Comp	Jl. Pemuda No.77 Tanjung Redeb, 77311	0821-1669-2222 / 05542122
Wonogiri	Raya Komputer (CV Raya Solusindo)	Jl. Ahmad Yani No. 56 Giripurwo Wonogiri - Jateng 57613	027-3323234
Yogyakarta	MIP Yogyakarta	Komp. Ruko Kuning No. 8 Jl. Ring Road Utara Condong Catur -Yogyakarta 55281	0274-557502
	Dot Print	Jl. Petung 1, Papringan - Jogjakarta 55321	0274-519725 / 085236139382

EPSON AUTHORISED SERVICE PARTNER

CORPORATE SERVICE PARTNER			
City	Name	Address	Phone
Batam	PT. Terang Inti Sejahtera	Ruko Four Season Blok B No. 21, Taman Duta Mas, Batam Centre, Batam - Kepri 29463	0778 - 469123 / 085271503333
Bekasi	PT. Solusi Sukses Pratama	Ruko Sampoerna Square No. 12 Jl. Raya Kranggan No. 37A Bekasi Jawa Barat 17433	021-28672601
	PT. Hade Multi Solusi	Graha Hade Jl. Wibawa Mukti II No.115, RT.003/RW.006, Jatiluhur, Kec. Jatiasih, Kota Bekasi Jawa Barat 17425	021-29062502
	PT. Polar Solusindo Utama	Ruko Kemang Permai No. 3A Jl. Siliwangi KM. 1 Sepanjang Jalan Rawa Panjang Bekasi 17114	021-82438202
	PT. Harmony Sistem	Jl. Dalang No. 8 Rawa Lumbu Bekasi Jawa Barat 17116	021-82401323
Jakarta	PT. Air Mas Servisindo	Ruko Cobastroke KH Zainul Arifin 2 Komplek Ketapang Indah Blok B1 No.10 Ketapang, Jakarta Barat 11140	021-22636555 / 085290808080
	PT. Elang Mandiri Solusi	Pusat Niaga Roxy Mas, Jl. Kh Hasyim Ashari No.9-12, RW.8, Cideng, Kecamatan Gambir, Kota Jakarta Pusat, Daerah Khusus Ibukota Jakarta 10150	021-50111351
	PT. Password Ritel	Jl. Jendral S. Parman Kav 77, Wisma 77 Tower 1 Lt. 15 Slipi, Jakarta Barat 11480	021-5363207
	PT. Albeta Sukses Mandiri	Jl. Kedoya Duri No.38A, RT.19/04, Kedoya Kec. Kb. Jeruk Jakarta Barat 11520	0215819908
	PT. Graha Digital Niaga	Ruko Duta Indah Alpha 2, Jl. Peta Selatan, Rt 08/01, Kalideres Jakarta Barat 11840	021-54313240
	PT. Data Retail Solution	Perkantoran Plaza Pasifik B4/81 Jl. Boulevard Barat Kelapa Gading, Jakarta Utara - 14240	021-4587 5368 / 4587 5369
	PT. Setia Sapta	Jl. Gajah Mada No. 183-184 Glodok Taman Sari Jakarta Barat 11120	021- 6296208 / 6499985
	PT. Intikom Berlian Mustika	Jl. Duren Tiga Raya No. 32 Rt 004/01 Duren Tiga, Pancoran, Jakarta Selatan 12760	021-52971700
	PT. Global Multimedia Technology	Jl. M Saari No 5 Rt 11/009 Sunter Jaya, Tanjung Priok, Tanjung Priok, Jakarta Utara 14360	021-22065580
	Malang	CV. Tunas Abadi	Jl. Jakarta No. 45B Malang Jawa Timur 65145
Semarang	CV. Mediadata Sejahtera	Jl. Menteri Supeno No.44B, Mugassari, Kec. Semarang Sel, Kota Semarang, Jawa Tengah 50249	08888545545
Surabaya	PT. Cahaya Inti Prima (3D Print Computer)	ITC Mega Grosir lantai.2 Blok G5 No. 1-3A, Jl. Gembong No. 20-30 Surabaya 60141	031-5476706 / 087852496899
Yogyakarta	CV. Top Distribusi	Kepuh Gk 3/953, Klitren, Gondokusuman, Yogyakarta 55222	0274-555475 / 08197555475

LARGE FORMAT & INDUSTRIAL PRINTER			
City	Name	Address	Phone
Bekasi	PT. Mandiri Artha Solusi	Ruko Sampurna Square, No.15 Jl. Raya Hankam Jatisampurna Kranggan Bekasi 17433 - Jawa Barat 17433	021-22813394 / 021-28672601
Depok	PT. Indonesia Graphic	Komplek Rukan Graha Depok Mas Blok A No. 5, Jl. Raya Arief Rahman Hakim, Depok Jawa Barat 16423	021-7829245 / 083808821483
Jakarta	CV. Media Grafindo	Green Sedayu Bizpark, Blok Dm.15 No.72 Jl. Daan Mogot Km.18 Jakarta Barat 11840	021-54315518 / 021-22520784
	PT. Mulia Mandiri Supply	Jl. Tongkol No. 6 BI, Ancol Pademangan Jakarta Utara- 14430	021-6910072
	PT. Samafitro Jakarta	Jl. Ir. H. Juanda No. 8 Jakarta Pusat - 10120	021-29495500
	PT. Aneka Warna Indah	Jl. Gn.Sahari N0.50A, RT01/RW01, Gn.Sahari Sel, Kec.Kemayoran Kota Jakarta Pusat 10610	021-6511009
Serpong	PT. Laysander Technology	Ruko Golden Boulevard R/21 Serpong Utara Bsd Tangsel - 15322	021-53161450
Surabaya	PT Samafitro Surabaya	Jemur Wonosari, Jl. Jemusari No. 313 Sidosermo, Kec Wonocolo, Kota Surabaya Jawa Timur 60299	031-841 3027 / 031-847 7779
	CV. 7 Droplet	Green Mansion Residence Blok N No. 12A, Jl. Ambeng-ambeng Selatan, Ngingas, kec Waru, Kab Sidoarjo, Jawa Timur 61256	031-85587722
	CV. Wujud Unggul	Kompleks Pergudangan Indoserena Blok A-19, Jabon, Tambaksawah, Waru, Sidoarjo Jawa Timur	031-99691147
Surakarta	CV. Sinar Citra Pratama	Jl. Sutan Syahrir No 25 Solo 57129	0271 647630 / 0811295876

EPSON NATION-WIDE DISTRIBUTOR

EPSON NATION-WIDE DISTRIBUTOR

Company Name	Address
CV TUNAS ABADI	Jl. Simpang Balapan No. 1, Kota Malang
PT ACA PACIFIC	Satrio Tower Lt 19. Unit 01 JL. Prof. Dr. Satrio Kav. C4, Kel.
PT GLOBAL MULTIMEDIA TEKNOLOGI	Ruko Mega Grosir Cempaka Mas Blok G No.11 RW.8 Kel. Sumur Batu, Kec. Kemayoran Jakarta Pusat. 10640
PT KOMINDO BIZOLUSI	Pusat Niaga Roxy Mas, Jl. KH. Hasyim Ashari No.9-12, RW 8, Kel. Cideng, Kec. Gambir, Kota Jakarta Pusat DKI Jakarta, 10150
PT MITRA NIAGA GEMILANG	Komp. Ruko Wijaya Kusuma No. 6 AB Jl. Daan Mogot No. 48 Grogol Petamburan Jakarta Barat 11460
PT PASIFIK INTERNUSA	Sudirman 7.8 Tower 1 Lt.26Jl. Jendral Sudirman Kav 7-8 Kec. Tanah Abang, Kota Jakarta Pusat. DKI Jakarta, 10220
PT REYCOM DOCUMENT SOLUSI	Pakarti Centre Building 6th FloorJl. Tanah Abang 3 no.23,25,27 Jakarta, 10160 Telephone 021-38901948
PT SETIA SAPTA	Jalan Gajah Mada 183-184, Jakarta 11120
PT SURYA SARANA DINAMIKA	Komp. Mega Sunter B-40, Jl. Danau Sunter Selatan, Jakarta
PT SYNnex METRODATA INDONESIA	APL Tower Lantai 42 Suite 1 - 8, Jl. Letjen S. Parman Kav. 28, Kel. Tanjung Duren Selatan, Kec. Grogol Petamburan, Jakarta Barat

EPSON AUTHORISED MASTER DEALER

City	Company Name
BALIKPAPAN	CV WIDYA WISESA
BANDUNG	PT ANEKA NIAGA GLOBAL PT SARANA SOLUSINDO SEJATI CV MEGA CV MASSCOM CV PRIMATECH VISINDO CV COMPUMAX MITRA SEJATI PT VISUAL INDO PERKASA PT LIEMARGA EKAPUTRA MANDIRI PT GREAT PRIMA LESTARI PT JESSTECH KEREN BANGET
BANJARMASIN	CV DATACOM PT BORNEO PRIMA UTAMA JAYA PT MULTI SARANA COMPUTER (LION COMPUTER)
BATAM	PT KARYA MURA NIAGA PT TERANG INTI SEJAHTERA
BOGOR	PT ZOOM INFOTEK TELESINDO
DENPASAR	CV ANEKA PIRANTI Cipta CV AYU WIRA
JAKARTA	CV ARTA MUARA PT KARYA ADHI GEMILANG PT DIGITEC JAYA INDONESIA PT FLEXIPOS MITRA ABADI PT MITRA INDO BHAKTI UTAMA PT INTIDATA SUPPLIES PT IS PRATAMA ABADI PT MAKRO INFORMASI TEKNOLOGI PT MEGATRONIX MITRANIAGA PT MILENIA MULTIVISI PT KARISA SUKSES ABADI PT PROSHOP MEGA JAYA PT PRATAMA Cipta LESTARINDO PT RAJAWALI MAHKOTA TEKNOLOGI PT PRIMROSE CEMERLANG LESTARI PT KHATULISTIWA JAYASAKTI ABADI PT HARYA PILAR UTAMA SUKSES PT DATA JAYA ABADI CV SUPER COMPUTINDO PT TEGUH KOMPUTAMA PT VIN SOLUSI COMPUTAMA CV MULTICASA PT GA TIGA BELAS CV X-COM MEDIA PT CENTRALTECH GLOBAL SOLUSI PT DATA RETAIL SOLUTION PT FOCUS INFOTAMA PT YAKIN ANUGERAH PERKASA PT PASSWORD RITEL SISTEM INDONESIA PT MASTERMEDIA UTAMA PT FESTINO INDONESIA CV EGP DISTRIBUSI PT DARMAWAN OPTIMA PROJEKTOR PT ITKLIK INDONESIA

City	Company Name
JAKARTA	PT JAYA UTAMA COM PT GRAHA MEDIA KOMPUTAMA PT IMAGO INOVASI INDONESIA CV TOPSON INDONESIA PT PILAR GLOBAL SOLUSI
JAMBI	PT ELEVEN KOMPUTER
MAKASSAR	PT ARIEL CREATIVE ELEVATION CV CAHAYA SURYA KOMPUTER PT VICTORIA JAYA KOMPUTAMA CV LASER COMPUTINDO PT KOMETINDO KOMPUTAMA
MANADO	CV MEGA INFORMASI CV HARMONI SUKSES MANDIRI
MEDAN	CV METRO ELEKTRONIK CV ABC ASIA PT HARSA MASTERINDO TEKNOLOGI
PADANG	PT SINARMULIA ANDALAS INFOCOM PT SEMANGAT BERKAT JAYA
PALEMBANG	CV BOBBY PUTRA PRATAMA PT MULTI DATA PALEMBANG CV MULTIKOM
PEKANBARU	CV RETYAN COMPUTER PT DWIWIRA PUTRA DINAMIKA
PONTIANAK	PT ANEKA MULTI SUKSES ABADI PT IT SOLUSINDO CV IRAMA KOMPUTER
SAMARINDA	CV LIDATA COMPUTER CV MITRA JAYA MANDIRI
SEMARANG	PT COMPUTEK INFOMART INDONESIA CV YESTOYA ABADI CV MULTI CASA SEMARANG CV GLOBAL KARUNIA TECHNOLOGY
SOLO	PT SADAR JAYA MANDIRI CV TUNGGAL OPTI PERSADA
SURABAYA	CV ANEKA CEMERLANG KOMPUTER PT KODE NIAGA TAMA PT SURYA MAKMUR KREASINDO PT KREASINDO Cipta NUSANTARA PT MULTI SARANA COMPUTER PT SURYA SATWIKA PT RAYA PERSADA SOLUSINDO PT LOGI DATA TEKNOLOGI CV DUTA SARANA SEJAHTERA
YOGYAKARTA	CV COMPUTA CV TOP DISTRIBUSI CV SINAR ABADI MULTIMEDIA PT RAKA PERKASA TEKNOLOGI

EPSON AUTHORISED DEALER

City	Company Name
ACEH	HIJRAH COMPUTER
ACEH BARAT	CV INDICOM
ACEH TAMIANG	LOGICA KREASI
AMBON	CV TIGA SEJAHTERA CV CENTRAL ANGKASA PRATAMA
ATAMBUA	CV THONBERS GEMILANG TEKNOLOGI
BAGAN BATU	PT ROKAN INOVASI TEKNOLOGI
BALIKPAPAN	CV CIPTA JAYA CV GATRA SUKSES ABADI CV SURYA JAYA SAKTI CV FULUSO COMPUTER CV TIARAKOM
BANDA ACEH	CV DUNIA KOMPUTER CV REFILL CENTER METRINDO.COM CV PUTRA SOLUSINDO COMPUTER CV SIMBADDA COM CV VIRTUAL COM CV ANGKASA PUTERA ABADI
BANDAR LAMPUNG	PT INTELINDO PUTRAPERDANA CV GLOBAL JAYA (BANDAR LAMPUNG) CV SINAR SUKMA WIJAYA CV SENTRA COMPUTER
BANDUNG	PT SIWA BANGUN PERSADA CV PILAR ABADI CV FAEYZA GEMILANG ABADI EXPO COMPUTER TOTIN COM / TOKO TINTA MEDIADATA SINAR ABADI PT PARON INDONESIA PT SARANA SOLUSINDO SEJATI PRIMA PARAHYANGAN KOMPUTER CV COMPUMAX MITRA SEJATI VISICOM PT SUPERTECH INTERNUSA CV PERSADA MANDIRI INDOPRINT PT GIRSANG TEKNOLOGI SOLUSI PT VISUAL INDO PERKASA CV SINAR BUDHI PT ABIRAMA KARYA TEKNIK PT AGRATAMA GLOBAL NIAGA PT INDOTEK BUANA KARYA PT MAKMUR EKA TEKNOLOGI CV ANNISA MANDIRI CV MANDIRI BERKAT SEJAHTERA
BANGGAI LAUT	CV BAWA KARAENG COMP
BANJAR	BM COMPUTER
BANJAR BARU	CV TWIN GROUP
BANJARMASIN	CV BERLIN KOMPUTERINDO CV ANEKA COMPUTER CV DATACOM CV INFO TECHNIC PT ANUGRAH TEKNOLOGI COMPUTER CV BANDUNG USAHA JAYA CV NUSANTARA JAYA

City	Company Name
BANTAENG	DELTA COMPUTER
BANYUWANGI	CV SENTRA DINAMIKA ASTON PRINTER BANYUWANGI CV SAHABAT CIPTA MANDIRI CV BINA USAHA MULTIKOM CV SINAR KENCANA
BARABAI	CV HIDAYAH TECHNOLOGY
BATAM	PT AZTECH KARYA MANDIRI IT STORE COM PT KARYA MURA KOMPUTER PT AIR MAS BATAM JAYA PT INK SHOP CENTER PRO COMPUTER CV TEKNOLOGI BATAM SOLUSINDO
BATANG	CV KARYA CIPTA MANDIRI
BATU LICIN	CV SMART JAYA TECH TOKO ANDHIKA
BATURAJA	CV JASU SRI WAHYU CV COMPUTERINDO BERKAT SEJAHTERA
BAU BAU	CV SATELLITE CV YANTI COM
BEKASI	PT XYZ GOPRINT INDONESIA PT WIRA NET SOLUSI
BELILAS	CV INTEL KOMPUTER
BENGKALIS	CV DWI MANDIRI
BENGGAYANG	CV BANLIE COMPUTING CV HARINDO UTAMA
BENGGULU	CV BIRU TEKNOLOGI MULTIMEDIA CV WIRA JAYA KOMPUTER
BERAU	G KOMPUTER CV PERDANA MAKMUR JAYA PT METRO RAYA INTIPRIMA CV ROBINSON KOMPUTER
BIAK	CV HANJAYA GEMILANG
BIMA	SENTRAL MUSLIM CV TIGA NUSA COMPUTER
BINJAI	ZIP COMPUTER ENTER COMPUTER BINJAI
BITUNG	SMART COMPUTER BITUNG
BLITAR	CV SENTRA MEDIA
BLORA	FEDORA COMPUTER CV MITRA PRATAMA KOMPUTINDO
BOGOR	CV MEGA PERKASA PT ZOOM INFOTEK TELESINDO CV ANEKA CITRA COMPUSINDO
BOJONEGORO	CV ASTON CAHAYA GEMILANG CV HITECH COM UD JEVA MULTI SEJAHTERA CV INDO SARANA MAKMUR
BONDOWOSO	UD PRINCE COMPUTER
BONE	CV SURYA INDAH COMPUTER KURNIA COMPUTER BONE
BONTANG	UD BINTANG PERDANA PRIMA
BOYOLALI	CV XP COMPUTER MEDIATAMA CV DIMENSI TIGA CV TERA

EPSON AUTHORISED DEALER

City	Company Name	
BUKIT TINGGI	PT CENTRAL MULTI COMPUTER	
	CV VGA KREASI SYSTEM	
BULUKUMBA	CV MEDIA KOMPUTER	
BULUNGAN	TOKO GRACIAS	
CANJUR	PT MULIA SARANA ABADI	
CIAMIS	PT ANUGRAH INTI MAKMUR (ANUGERAH COMPUTER)	
	CV MEDIA INFORMATIKA COMPUTER CIAMIS	
	CV KURNIA KOMPUTER	
CIANJUR	CV MITRA JAYA KOMPUTINDO	
CILACAP	BASS COMPUTER	
	CV KARTIKA DWIGUNA	
CIMAH	CV NISCAYA BERKAH	
CIREBON	CV MITRA INDEXINDO PRATAMA ASIA COMPUTER	
	CV ANEKA NIAGA SENTOSA	
	PT JAYA PRATAMA COMPUTINDO	
	CV MANJAYA KOMPUTER	
	PT ISTANA KOMPUTINDO	
	CV ALFA TEKNOLOG DIGITAL	
	CV SINAR TERANG	
	PT SATYA KENCANA TEKNOLOGI	
	CV POLARIS KOMPUTAMA	
	CV SANGRIA MANDIRI COMMUNICA	
	CV INDO AURUM	
	DEMAK	PRIMA KOMPUTER
	DENPASAR	PT BALI SATU COMPUTER
		ADI RAYA KOMPUTER
		DNA KOMPUTINDO
		PT ARTHA BALI COMPUTINDO
CV GLOBAL JAYA SEJAHTERA		
CV INDOTECH		
ASTIKOM		
CV BALI TECHNO GROSIR COMPUTER		
PT BALI YONI SAGUNA		
PT MASTERDATA BALI		
CV Z4COMP		
CV SRI SEDANA MESARI		
CV BALI IT SOLUSI		
DEPOK	PT GIAN TEKNOKINDO SOLUSI	
DUMAI	MAESTRO KOMPUTER	
	CV DELTA TEKNOLOGI	
	CORPORINDO	
	CV SOLUTION TECHNOLOGY	
DURI	NEW COMPUTER CITY	
FLORES	CV ERA CIPTA RAYA	
GARUT	PT MAKMUR ESENSI INDOSETIA	
	PT GOLDEN HASANAH INDONESIA	
GORONTALO	ISTANA DISC COMPUTER	
	CV GORONTALO COMPUTER	
	PT SQUARE GORONTALO	
	CV TAMPAL PRINTER	
	PT REJEKI MITRA SEJAHTERA	
	CV CIPTA KENCANA SEJAHTERA	
CV SPECTRUM MEDIATAMA		
GRESIK	CV TERACOM CIPTA PERSADA	
GROGOT	C-PRINT	

City	Company Name
HULU SUNGAI	CV YULIDA
UTARA	
INDRAGIRI HILIR	CV AKASIA TSURAYYA
	EDY COMPUTER
INDRAMAYU	CV PERSONAL KOMPUTER
	CV TUAIAN BERKAT
	PT SIS KENCANA MAS
	CV MULTI KARYA SUKSES
	PANEN RAYA
	PT ANGEL SOLUSI TECHNOLOGY
	PT SINGA MULIA ABADI
	PT DWI TUNGGAL SEJAHTERA
	PT CEMERLANG ABADI COMPUTINDO
	CV DUNIA MAS COMPUTER
	CV LIGA INTI RAYA
	PT DATAPPOINT
	PRIMAX COMPUTER
	PT EXCELINDO SEJAHTERA
	PT PHOENIXINDO SUKSES
	PERKASA
	PT IS PRATAMA ABADI
	PT BINTANG RAYA KOMPUTAMA
	PT INTEGRA INFOTEK SOLUSITAMA
PLAZA COMPUTER	
CV SUPER COMPUTINDO	
CV NATHAN SUKSES MAJU JAYA	
PT ARMINDO MANDIRI	
CV METAMA COMINDO NUSA	
CV DUTAMATRIX JAYA PERKASA	
PT CIPTA MITRA SOLUSINDO	
SUN JAYA COMPUTER	
SETIA JAYA COMPUTER	
CV BERKAH GLOBAL PERSADA	
CV VE NUSANTARA	
DUTA 1 (ONE)	
CV INTI RAYA UTAMA	
GOLDEN SWAN COMPUTER	
PT BASIS DWI NIAGA	
PT TUJUH ANUGRAH ABADI	
PT MILENIA MULTIVISI	
SANGKAKALA	
PT MEGATRONIX MITRANIAGA	
PT DIGITEC JAYA INDONESIA	
PT SOLUDEA KARYA INDONESIA	
PT SYIFA JAYA SEJATI	
PT KALLISTA KOMPUTER TEKNOLOGI	
PT SUKSES COMPUTINDO ABADI	
PT METEOR INDORETAIL COMPUTAMA	
PT DUNIA KOMPUTER INDONESIA	
PT TEKNO MANDIRI ABADI	
PT AGRES INFO TEKNOLOGI	
UD JAYA MAKMUR	
CV EASY MITRA	
PT TEGUH KOMPUTAMA	
PT PELITA CAHAYA TEKNOLOGI	
CV JAYA MANDIRI	
PT KREASI CIPTA COMPUTINDO	

EPSON AUTHORISED DEALER

City	Company Name
JAKARTA	PT WIDJOYO MITRA ABADI
	PT FLEXIPOS MITRA ABADI
	PT PIANO INTEL KOMPUTER
JAMBI	CV ANDIKA SURAYA KOMPUTER
	PT VICTORY TECHNOLOGY ABADI
	PT MASTERDATA JAMBI
JAYAPURA	CV ALVA MEDIA KOMPUTINDO
	CV DUNIA KOMPUTER (JAYAPURA)
	CV MASTER COMPUTER
JEMBER	CV ABEKOM JAYA ABADI
	CV ELANG INDONESIA
	PT BITCOM
	PT DUTA SAMUDRA PASIFIK
	JAYA COMPUTER JEMBER
JEPARA	PT SENYUM MEDIA UTAMA
	CV ASIA JAYA
	CV SAFRINDO PERKASA
JOMBANG	CV DWI PERKASA (SEMARANG COMPUTER)
	CV MITRA DATA BERJAYA
KAB BANDUNG	CV SINAR MANDIRI SOLUTION
KANDANGAN	CV HITRO
KAPUAS HULU	ELGIN COMPUTER
KARANGANYAR	CV MITRA KOMPUTER
	CV CAHAYA PUTRA MANDIRI
	PRIMA COMPUTER (PC)
KARAWANG	CV MEGATAMA SOLUSINDO
	CV PRISMA UTAMA
	CV MITRA KS UTAMA
KAYONG UTARA	CV BERKAH LAPAK UTAMA
KEBUMEN	CV VISUAL
KEDIRI	CV FM. 90
	CV MITRA JAYA
	CV RAHARJA SEJAHTERA
KENDAL	CV MAJU MAPAN ABADI
	AL BUMI IT STORE
	PT KAY DIGITAL TECHNOLOGI INDONESIA
KENDARI	CV KREASI COMPUTER
	CV MENTARI COMPUTINDO
	CV TIGA TUJUH TEKNOLOGI KOMPUTER
	RAKA MEDIATECH
	UD KALAM HIDUP
	CV RC COMPUTER
	CV ANUGERAH DAMAI
	SEJAHTERA
CV TUMAKA	
KETAPANG	CV METRO IT
	CV R COM
KISARAN	CV F3I
KLATEN	INTAN COMPUTER
	AS COMPUTER
KOTAMOBAGU	SIGMA COMPUTER
	CV CARPERCOM
KOTAWARINGIN BARAT	CV ACOMP
	CV RHAVA COMPUTINDO
	CV STARINDO COMPUTAMA
	CV ANUGRAH CIPTA MANDIRI

City	Company Name
KOTAWARINGIN TIMUR	CV PRIMA UTAMA
KUBU RAYA	TOKO WAYCOM
KUDUS	SINAR JAYA COMPUTER
KUNINGAN	CV EGYD
KUPANG	CV DUTA MULTI COMPUTER
	PT UNISTAR SARANA JAYA
	CV KHARISMA KOMPUTER
	CV PERDANA GLOBALINDO
	PT BINTANG TIMOR SUKSES SEJAHTERA
KUTA	CV DELTA SUKSES
KUTAI KARTANEGARA	ERICK VON GOTTLIEB COMPUTER
	UD DUO HATI BERSAUDARA
	CV RE KOMPUTER
KUTAI TIMUR LAHAT	CV SENTRAL SOLUSI SEJAHTERA
	CV GLOBAL GROUP
	RAJA COMPUTER
LAMANDAU	JEMMY COMPUTER
	CV WANGI RATANA
	INFORMATIKA
LAMONGAN	MY COMPUTER
LEBAK	CV HAMBA PUTRA
LHOKSEUMAWE	PT TIGA PENDEKAR SEJAHTERA
	CV DUNIA COMPUTER
LOMBOK	CV J COM
	CV KURNIA DIGITAL SOLUSINDO
LOMBOK TIMUR	NUSA PERDANA
	CV MARSYA COMPUTER
LUBUK LINGGAU	CV DELTA
	CV SIGMA KOMPUTER
LUBUK PAKAM LUMAJANG	ARTECH COMPUTER
	ICON KOMPUTER
	CV CITRA ABADI
Luwuk	CV PASTI JAYA
	CV LAB PERSADA
	CV MALEO KOMPUTER
	CV BRAGA SUKSES BERSAUDARA
	CV JAYA RAYA KOMPUTINDO
Luwuk BANGGAI	TOKO SMART COMPUTER
	CV GLOBAL ICHITEKNO
MADIUN	CV MAJU BERSAMA
	CV ISTANA KOMPUTER MANDIRI
	CV BIMA DIANIMAS NUSANTARA
MAGELANG	CV TUNGGAL OPTI PERSADA
	CV MICRO COMPUTER
	CV EMIRATES KOMPUTER
MAKASSAR	CV LASER COMPUTINDO
	CV CIPTA ZAQI PERSADA
	CV LADANG TANAH EMAS
	LAKSANA ELANG
	PT CAHAYA INDOKOM
	CV ELEXTRA
	PT SURYA ANUGRAH
	KOMPUTINDO
	PT RAMA PRIMAVERA
	PT SONIC KOMPUTER INDONESIA
CV MAKASSAR PRINT	
PT HND KOMPUTAMA	

EPSON AUTHORISED DEALER

City	Company Name	
MAKASSAR	PT MEGARICH MITRA JAYA	
	PT GENIUS COMPUTER CENTRE	
	PT VICTORIA JAYA KOMPUTAMA	
	PT MAHADEWA TEKNOLOGI KOMPUTINDO	
	PT KOMETINDO KOMPUTAMA	
	CV CAHAYA SURYA KOMPUTER	
	MANAR COMPUTER	
	BUMI MAKMUR KOMPUTER	
	CV ALVATECH	
	PT KEYLA WILSON ABADI	
	CV PROTON SUKSES BERSAMA	
	PT MUGEN MULTI DISTRIBUSI	
	PT CELEBES CEMERLANG INDONESIA	
	CV SMART MEDIA CEMERLANG	
	PT PROTOTIN SINERGI INDONESIA	
	TOKO SUKSES JAYA	
	CV MILAN JAYA KOMPUTAMA	
	PT ARIEL CREATIVE ELEVATION	
	CV ECOMPUTEX DISTRIBUSI	
	MALANG	HARTONO 2 COMPUTER
CV IN MULTIMEDIA		
NGALAM COMPUTER		
GALAXY SOLUSINDO		
CV IJEN COMPUTER		
SEMESTA GROUP		
CV ESA MEDCO TECHNOLOGY		
MALINAU	CV ANGKASA COMPUTER CENTER	
	CV CLAVIE	
MAMUJU	IFAH COMPUTER	
	PT FANTASI JAYA ABADI	
MANADO	CV INTERTECH	
	CV TERMINAL KARYA MANDIRI MEDIA PRIMA	
	CV KAWANUA JAYA MANADO	
	CENTRAL GAME	
	CV LEVEL DUA PUTRI	
	NEUTRON COMPUTER	
	CV REMPAH MANADO	
	ISTANA COMPUTER	
	MANOKWARI	CV GALERINDO KOMPUTAMA
		CV MAKARIOS
MATARAM	CV REVAYAH SUMBER BERKAT	
	CV MATRIX COMPUTER	
	CV SATU SATU JAYA	
	CV KABAR GEMBIRA	
	CV CATUR WARGA COMPUTER	
	CV RINJANI MANDIRI SEJAHTERA	
	CV DUNIA ALAT TULIS LOMBOK	
MEDAN	ECOTECH COMPUTER	
	CV CITRALOKA	
	CV SIMONE COMINDO	
	THREE NINE	
	SUPERTECH COM	
	PT HOKI ABADI SENTOSA	
	OK COMPUTER	
	MEDIA COM	
	MITRA INTERMEDIA	
	PT ADHIMUKTI KARYA BERSAMA	

City	Company Name
MEDAN	CONTEC JAYA
	CV MANDIRI SUCCESS JAYA
	BENUA JAYA COMPUTER
	CV HERO KOMPUTER
	SURE COM
	CV GEMILANG JAYA PERKASA
	PT LOGIKREASI UTAMA
	CV MIKROTEK KOMPUTINDO
	REZEKI JAYA KOMPUTER
	PT SUMBER UTAMA NUSANTARA
	PT DAYAMEGA PRATAMA
	CV JAYA ABADI MEGAH
	CV SAMA SIDE
	PT PRIMAJAYA MULTI TECHNOLOGY
	CV HIDUP BARU TEKNOLOGI
MELAWI	CV ABC ASIA
	MAJU JAYA COMPUTER WAROENG IT
MELAWI	PT KOMDISC SUKSES TEKNOLOGI
	MERAUKE
METRO	CV STARCOM
	CV PADI
MEULABOH	PT INSAN MITRA TEKNOLOGI
	CV ADA COM
MOJOKERTO	CV MULTI MEDIA
	ANTASARI COMPUTER IT CORNER
MUARA BUNGO	PT MITRA KOMPUTER BUNGO
	CV AMINOS COMPUTER
MUNTILAN	CV ASIA CENTRAL COMPUTER
	ARYA PANDAWA
NABIRE	CV SURYA ABADI
	CV MITRA MULYA KOMPUTER
PACITAN	PT SEMANGAT BERKAT JAYA
	CV VENES JAYA
PADANG	PT HEDIMAN KHARISMA MANDIRI
	CV MAX-INDO
PAINAN	CV PANEN RAYA JAYA
	CV FITRA PRATAMA
PALANGKARAYA	PT UNIVERSAL SELULER COMPUTINDO
	CV LOGOS MANDIRI
PALEMBANG	CV MITRA PERSADA KOMPUTER
	CV MULIA JAYA
PALU	CV BOBBY PUTRA PRATAMA
	PT MULTI DATA PALEMBANG
PALU	CV INTI MANDIRI PERMATA
	CV ZOOM IT SOLUTION
PALU	CV GALANG SPIDER COMPUTER
	CV ARUNA MULTI COMPUTER
PALU	UD METEOR COMPUTER
	PT ALYA PRIMA VERA
PALU	CV SHUNU ARTHA CEMERLANG
	CV LIBRA COM
PALU	CV LIMA NET
	SINAR MAKMUR COMPUTER (SMC)
PALU	CV ALEXANDRA
	CV DREAM UTAMA GROUP
PALU	CV LAGUNA KONS
	CV GLOBAL JAYA (PALU)
PALU	CV KURNIA BARU

EPSON AUTHORISED DEALER

City	Company Name
PAMEKASAN	SARANA INTI DATA
	CV MEGA DUTA COMPUTINDO
PANGKAL PINANG	CV WELLS PRATAMA MANDIRI
	CV DEDE COMPUTER
	CV DUTA BINTANG UTAMA
	CV SENTRA KOMPUTER
PARIAMAN	UD SURYA KOMPUTER
PARIGI	CV PRIMA COMPUTER
PARINGIN	CV DATA GARUDA BLG
PASURUAN	CV ANEKA SARANA COMPUTER
	CV KARISMA JAYA ABADI
	CV MITRA UTAMA
	CV YAP COM
PATI	CV PRIBUMI JAYA KOMPUTAMA
	MICRO PRINTER
	CV PUTRA MANDIRI
PAYAKUMBUH	PT INDO ALBANI TEKNOLOGI
	CV MITRA GROUP
PEKALONGAN	CV MULTINET KOMPUTER
	SURYA COMPUTER - PEKALONGAN
PEKANBARU	CV MEGA KOMPUTAMA PERKASA
	CV BITCOM NUSANTARA ELEKTRONIK
	CV IT JAYA PRATAMA
	CV JAYA MITRA ABADI
	NEW EDYCOM
	CV BEST COMPUTER
	CV RETYAN COMPUTER
	CV SEJAHTERA IT SOLUTION
	CV TEKNO KOMPUTER
	CV COMPUTER SQUARE
	TOKO UTAMA KOMPUTER
	CV MULTI MEDIA KOMPUTER
	PT TOBA MAKMUR PERKASA
	CV MEDIA ERA GLOBAL
	CV MULIA JAYA PRATAMA
	CV IRAMA PUTRA MANDIRI
	CV GABE INDO PERKASA
PEMALANG	KRAKATAU JAYA
	CV ODYSSEY
PEMATANG SIANTAR	MANRAPI COMPUTER
	KARTIKA CELL & COM
PIDIE	GALERY COMPUTER
PINRANG	SINAR KOMPUTER
POLEWALI MANDAR	CV REVOLUTION PRATAMA
PONOROGO	PT ANEKA MULTI SUKSES ABADI
	CV CIPTA MULTI JASA
	KURA KOMPUTINDO (KURAKOM)
	CV ZONA MULTIMEDIA
	PT IT SOLUSINDO
	PT DATACOM DIGITAL
	CV MENARA SQUARE
	CV USAHA JAYA ABADI
	CV ARTHA JAYA PRIMA
	PT CIPTA SARANA INTEGRASI
	CV DATA BASIS TECHNOLOGY
	CV COMCOW CENTRANUSA
DUTA COMPUTER	
CV ASTERINDO	

City	Company Name
PONTIANAK	CV ELITE KOMPUTINDO
	PEGASUS COMPUTER (PONTIANAK)
	CV MENARA GRUP
	CV JAWARA GRUP COMPUTINDO
PRABUMULIH	CV PRABU KOMPUTER
PRINGSEWU	CV GLOBAL COMPUTER
PROBOLINGGO	CV RINJAYA ELECTRINDO
	CV MEDIA TEHNIK COMPUTINDO
	WIJAYA COMPUTER
	THECOM PUSAT
	CV YOTTA TECH
PURBALINGGA	CV FASTABIC
PURWAKARTA	CV TRIPIO COMPUTER
PURWOKERTO	PT PELITA SATRIA PERKASA
	AXIA COMPUTER
	CV SISWOYO
	CV KREASI MANDIRI
	PT ALFA GIG
PURWOREJO	CV MEDIA TEKNOLOGI
	CV MULTI BERKAH SOLUSI
SALATIGA	PT ASTON PRINTER INDONESIA
	MULTI JAYA TEKNIK
	CV PRINTERKU JAYA SEJAHTERA
	PERDANA JAYA COMPUTER
	CV BINTANG JAYA KOMPUTER
	CV MITRA JAYA MANDIRI
	PT HARTORA KANONDATIM
	PRADANA
	CV DUTA SARANA COMPUTINDO
	CV SMART
	CV ARINGO RAYA
	CV PREGA LESTARI
	BAZZAR COMPUTER
	CV MASTERPIECE
	DJONIE PRINT
	PT SALIM SURYA PHONE
	CV JAVA COMPUTER SAMARINDA
CV TBOX PRIMA PERKASA	
SAMBAS	PEDOMAN COMPUTER
	CV MEDIA COMPUTER
SAMPIT	CV DATA MENTAYA
	METTA YOUTH DIGITAL STUDIO
SANGGAU	TOKO KINGDOM COMPUTER
	CV ZOOM
	CV VAN'S COMPUTER
SAROLANGUN	DOKTER KOMPUTER
SEKADAU	NEW GLORIA COMPUTER (NGC)
	CV NEO COMPUTER
SEMARANG	CV RAJA PRINT SOLUTION
	PIXEL INKJET SOLUTION
	PT HARRISMA TEKNOLOGI INDONESIA
	PT HETERO NIAGA GLOBAL
	CV YESTOYA ABADI
	PT INFOKOM PUTRA KENCANA
	CV TRINITY GROUP
	CV KARYA HIDUP MULYA
	ARIEL IT COMPUTER
	CV BERKAH JAYA COMPUTINDO
PT ARTHA INDONESIA TEKNOLOGI	
SERANG	CV BERKAH JAYA COMPUTINDO
	PT ARTHA INDONESIA TEKNOLOGI
SIBOLGA	CV MODERN COMPUTER

EPSON AUTHORISED DEALER

City	Company Name
SIDOARJO	CV MATAHARI MAKMUR
	PT INTERMEDIA COMPUTER INDONESIA
	CV GLOBAL AMALIA PRATAMA
	CV USAHA BERSAMA
SIGLI	CV RAINBOW NUSANTARA
	ORION COMPUTER
SINGKAWANG	CV MARYSA COM
	CV CENTRAL KOM
SINJAI	CV MEDIA SARANA
	CV AMALIA UTAMA KOMPUTER
SINTANG	CV GLORIA COMPUTER
	CV SAINTS COMPUTER
SITUBONDO	MITRA COMPUTER
	UD SITCOMP
	KAIROS COMPUTER
SLEMAN	CV SIGIT
	CV INDOPRINT SEJAHTERA ABADI
SOLO	CV RISC COMPUTER
	PT MANXI IMAGE PERKASA
	CV PRIMA MITRA ABADI
	PT ANDALAS SURYA GEMILANG
SORONG	PT SADAR JAYA MANDIRI
	TOHO COMPUTER
STABAT	CV AORA SUMBER SOLUSINDO
	VISTA COMPUTER (VC)
SUBANG	PUTRI COM
	CV KANABA SEJAHTERA
SUKABUMI	MS COMPUTER
	RNY COMPUTER
SUKAMARA	SAHABAT KOMPUTER & ELEKTRONIK
SUKOHARJO	AKASIA KOMPUTER
SUMBAWA	CV RISKY MEDIA COMPUTER
BESAR	CV MITRA MANDIRI
SUMEDANG	PT CAHAYA INTI PRIMA
	PLATINUM COLOUR
	CV INDOCOM SUKSES MAKMUR
	MARKAS PRINTER.COM
	CV ALFAPRINTER PERDANA MANDIRI
	ARRABON COMPUTER
	SKY PRINTING
	CV OPTIMA UNION SUKSES
	CV DB KLIK
	PT METROKOM JAYA
	PT SUN DIGITAL TEKNOLOGI INDONESIA
	PT SURYA ARTHA KOMPUTAMA
	CV CAHAYA ABADI PERSADA
	GAJAH MADA KOMPUTER
	PT ANUGRAH TUMBUH KHARUNIA
	PT KREASINDO CIPTA NUSANTARA
CV TRIJAYA SUKSES MANDIRI	
PT LOGI DATA TEKNOLOGI	
CV WIJAYA TECHNOLOGY INDONESIA	
CV KARYA SATYA TEKNOLOGI	

City	Company Name	
SURABAYA	AIPEL COMPUTER	
	GOLD INK CENTER	
	PT NUSAJAYA SEJAHTERA COMPUTER	
	PT SURYA CAKRA	
	CV BERKAT ABADI COMPUTINDO	
	PT ASIAMAS TEKNOLOGI GROSIRIA	
	PT BERKAT SUBUR LESTARI	
	CV KARYA MAJU PERDANA	
	CV DYNAMEDIA SOLUSI TEKNOLOGI	
	CV SELALU ADA SOLUSI	
	CV DUTA SARANA SEJAHTERA	
	CV SINAR SAMUDRA	
	CV CELLCOM ID LENOVO STORE	
	PT SURYA SAKTI TEKNOLOGI INDONESIA	
	CV SEMBILAN TEKNOLOGI	
	PT MIXITECH GRAHA TEKNIK	
CV SURYA PREMIUM		
CV BERIN INFORMATIKA		
PT DORAN SUKSES INDONESIA		
CV NOAH SEJAHTERA ABADI		
PT SERUNI INDAH SEMESTA		
TAKENGON	MVP COMPUTER	
TANGERANG	PT HARTA JAYA SENTOSA BERSAUDARA	
	PT MITRA MARGA SEJAHTERA	
	PT PIRAMIDA INTI PERSADA	
	PT THEA THEO STATIONARY	
	PT DUTA TEKNOLOGI NUSANTARA	
	CV MAJU JAYA ABADI	
	PT PUTRI INTI SUKSES	
	CV MITRA SUKSES MANDIRI	
	TANGERANG SELATAN	IRWAN COMPUTER
	TANJUNG	TECHNO INFINITY
TANJUNG BALAI		
KARIMUN		
TANJUNG MORAWA	PT BINTANG TEKNOLOGI SEMPURNA	
TANJUNG PANDAN	CV MULTI SARANA UTAMA	
TANJUNG PINANG	TOKO FORCE	
	INFOTECH COMPUTER	
	GLOBAL IT	
	PT DIGITAL MANDIRI JAYA	
	STANDARD COMPUTER	
	CV PLUS-PLUS	
	ADIN PRINTER	
	CV SEMESTA KOMPUTAMA	
	CV MEGAH GLORY	
	MITRA UTAMA KOMPUTER	
PEGASUS COMPUTER		
CV ANUGRAH ABADI PRATAMA		
PT PUTRAPUTRA LANGGENG JAYA		
CV INDO KOMPUTER		
CV NEW LIFE COMPUTER		
CV ANUGERAH DAFA LESTARI		
CV TRENDS COMPUTECH		
TARAKAN		
TASIKMALAYA		
TEBING TINGGI		
TEGAL		

EPSON AUTHORISED DEALER

City	Company Name
TEMBILAHAN	CV MATRIX PERKASA
TERNATE	PT DATAGRID MAESTRO TEKNO CV GIGA COM CV MARS JAYA
TIMIKA	CV ITHSAN INFOTIKA CV INDOPRIMA JAYA GALILEA KOMPUTER PAPUA
TORAJA	CV MULTICOM ANUGRAH PERSADA BALBOD COMPUTER CV POWER DIGITAL COMPUTER
TUBAN	MITRA SEJATI KOMPUTER CV VICTORY INDO PRATAMA
TULUNGAGUNG	MAXINDO COMPUTER CV LAUTAN BERKAT ABADI RADJA COMPUTER CV DHARMA INTI NUSA
WAINGAPU	CV GLOBAL TEKNIK
WONOGIRI	CV RAYA SOLUSINDO
WONOSOBO	JUZZI COMPUTER

City	Company Name
YOGYAKARTA	PT HARRISMA BUWANA JAYA CV KANA CHANNEL COMPUTER PRIMA COMPUTER CV SUKSES SEJATI COMPUTAMA CV ANNISA COMPUTER RAJA INK YOGYAKARTA PT SETIA HARAPAN COMPUTER CV FAHANA CITRA CV AIZZA CV BERKAH SEMESTA ALAM CV BELLA CAHYA CV JAYA UTAMA SUKSES PT DINAMIKA PERKASA JAYA CV SEMESTA JAYA COMPUTINDO CV STAR MEDIA COMPUTAMA PT SEMPURNA SEJAHTERA KOMPUTINDO WARA COMPUTER PT WISNO GRAHAKOM CV METROCOM

EPSON

BE cool



EMBRACE SUSTAINABILITY WITHOUT INCREASING COSTS.

Looking to reduce your environmental impact without compromising on performance or making significant investments? Our business solutions are more efficient and sustainable, every step of the way. From Heat-Free printing and Dry Fiber recycling technology to power-saving Laser projectors and scanners to digitise documents, we focus on the details that make a world of difference. So, when it comes to the business of saving energy and reducing environmental impact, we've got you covered.

Make the switch at www.epson.co.id/becool

IT'S IN THE DETAILS.

www.epson.co.id/ecotank

INKTANK PRINTER



INKTANK PRINTER

MENGAPA MEMILIH ECOTANK ?

Printhead seri EcoTank dengan teknologi *Micro Piezo* merupakan teknologi eksklusif dari Epson. Dirancang bekerja andal dan tahan lama. *Printhead Micro Piezo* memungkinkan pencetakan pada berbagai jenis media. Adapula fitur cetak cepat, pemrosesan gambar, sistem tinta, tinta, pemindahan kertas dengan sangat akurat dan mekanisme lainnya.

PrecisionCore

PrecisionCore adalah teknologi printhead yang berupa lapisan tipis unik *piezo* (TFP) yang memadukan teknologi komponen superior dengan teknologi fabrikasi *Micro-Electro-Mechanical-System (MEMS)* yang berpresisi tinggi. Hasilnya adalah kecepatan cetak dan mutu gambar yang tinggi untuk pemakaian di berbagai kegiatan usaha dan industri.

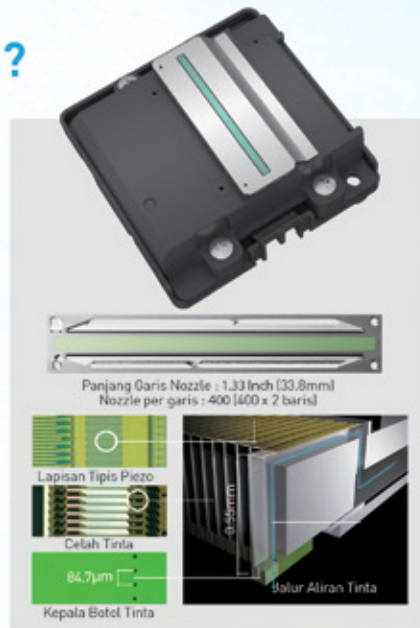

BOTOL TINTA UNIK YANG DAPAT BERHENTI OTOMATIS DAN TANGKI TINTA MUDAH DIISI ULANG



Tangki tinta menghadap ke depan untuk mempermudah pengisian ulang tinta.



Tidak akan ada kesalahan pengisian ulang tinta karena setiap desain saluran memiliki bentuk berbeda.

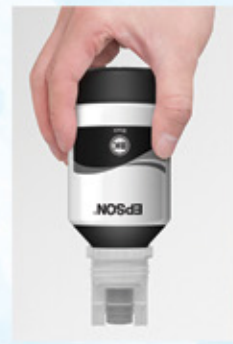

Tidak tumpah.

INKTANK PRINTER

Printer Warna Printer Multifungsi untuk Perkantoran / SOHO



L6290



- Printer Type** Print, Scan, Copy, Fax with ADF
Technology PrecisionCore™ Printhead
Ink 4 Colours Epson Genuine Ink Bottle
Print Resolution 4,800 x 1,200 dpi
(with Variable-Sized Droplet Technology)
Print Speed Up to 33 ppm / 20 ppm
Copy Resolution 600 x 600 dpi
Copy Speed Up to 11 ipm / 5.5 ppm
Scan Resolution 1,200 x 2,400 dpi
Scan Speed Monochrome 200 dpi: 12 sec, ADF ; 5.0 ipm
Colour 200 dpi: 27 sec, ADF : 5.0 ipm
Connectivity USB 2.0, Ethernet, Wi-Fi IEEE 802.11b/g/n,
Wi-Fi Direct
Epson Connect Epson iPrint, Email Print, Remote Print Driver,
Scan to Cloud
Other Mobile Solution Apple AirPrint, Mopria Print Service,
Epson Smart Panel
Warranty 2 years or 50,000 pages
Ink Model 001



L6270



- Printer Type** Print, Scan, Copy with ADF
Technology PrecisionCore™ Printhead
Ink 4 Colours Epson Genuine Ink Bottle
Print Resolution 4,800 x 1,200 dpi
(with Variable-Sized Droplet Technology)
Print Speed Up to 33 ppm / 20 ppm
Copy Resolution 600 x 600 dpi
Copy Speed Up to 11 ipm / 5.5 ppm
Scan Resolution 1,200 x 2,400 dpi
Scan Speed Monochrome 200 dpi - Flatbed : 12 sec / ADF ;
5.0 ipm
Colour 200 dpi - Flatbed : 27 sec, ADF : 5.0 ipm
Connectivity USB 2.0, Ethernet, Wi-Fi IEEE 802.11b/g/n,
Wi-Fi Direct
Epson Connect Epson iPrint, Email Print, Remote Print Driver,
Scan to Cloud
Other Mobile Solution Apple AirPrint, Mopria Print Service,
Epson Smart Panel
Warranty 2 years or 50,000 pages
Ink Model 001

INKTANK PRINTER

Printer Warna
Printer Multifungsi untuk Perkantoran / SOHO

L6260



- Printer Type** Print, Scan, Copy
Technology PrecisionCore™ Printhead
Ink 4 Colours Epson Genuine Ink Bottle
Print Resolution 4,800 x 1,200 dpi
(with Variable-Sized Droplet Technology)
Print Speed Up to 33 ppm / 20 ppm
Copy Resolution 600 x 600 dpi
Copy Speed Up to 11 ipm / 5.5 ppm
Scan Resolution 1,200 x 2,400 dpi
Scan Speed Monochrome 200 dpi: 12 sec
Colour 200 dpi: 27 sec
Connectivity USB 2.0, Ethernet, Wi-Fi IEEE 802.11b/g/n,
Wi-Fi Direct
Epson Connect Epson iPrint, Email Print, Remote Print Driver,
Scan to Cloud
Other Mobile Solution Apple AirPrint, Mopria Print Service,
Epson Smart Panel
Warranty 2 years or 50,000 pages
Ink Model 001

L5290



- Printer Type** Print, Scan, Copy, Fax with ADF
Technology On Demand Inkjet (Piezoelectric)
Ink 4 Colours Epson Genuine Ink Bottle
Print Resolution 5,760 x 1,440 dpi
(with Variable-Sized Droplet Technology)
Print Speed Approx. 33 ppm / 15 ppm
Copy Resolution 600 x 600 dpi
Copy Speed Up to 7.7 ipm / 3.8 ipm
Scan Resolution 1,200 x 2,400 dpi
Scan Speed Monochrome - Flatbed : 12 sec / ADF : 4.5 ipm
Colour - Flatbed : 29 sec / ADF : 4.5 ipm
Connectivity USB 2.0, Ethernet, Wi-Fi IEEE 802.11b/g/n,
Wi-Fi Direct
Epson Connect Epson iPrint, Epson Email Print, Remote Print
Driver
Other Mobile Solution Apple AirPrint, Mopria Print Service,
Epson Smart Panel
Warranty 2 years or 30,000 pages
Ink Model 003

INKTANK PRINTER

Printer Warna Printer Multifungsi untuk Perkantoran / SOHO



L5590



- Printer Type** Print, Scan, Copy, Fax with ADF
- Technology** PrecisionCore Printhead
- Ink** 4 Colours Epson Genuine Ink Bottle
- Print Resolution** 4800 x 1200 dpi (with Variable-Sized Droplet Technology)
- Print Speed** up to 33 ppm / 20 ppm
- Copy Resolution** 600 x 600 dpi
- Copy Speed** up to 10.8 ipm / 5.5 ipm
- Scan Resolution** 1,200 x 2,400 dpi
- Scan Speed** Monochrome 200 dpi - 12 sec / 5.0 ipm
Colour 200 dpi - 29 sec / 5.0 ipm
- Connectivity** USB 2.0, Ethernet, Wi-Fi IEEE 802.11b/g/n, Wi-Fi Direct
- Epson Connect** Epson iPrint, Epson Email Print, Remote Print Driver
- Other Mobile Solution** Apple AirPrint, Mopria Print Service, Epson Smart Panel
- Warranty Ink Model** 2 years or 50,000 pages 003

L4260



- Printer Type** Print, Scan, Copy
- Technology** On Demand Inkjet (Piezoelectric)
- Ink** 4 Colours Epson Genuine Ink Bottle
- Print Resolution** 5,760 x 1,440 dpi (with Variable-Sized Droplet Technology)
- Print Speed** Up to 33 ppm / 15 ppm
- Copy Resolution** 600 x 600 dpi
- Copy Speed** Up to 7.7 ipm / 3.8 ppm
- Scan Resolution** 1,200 x 2,400 dpi
- Scan Speed** Monochrome 200 dpi: 11 sec
Colour 200 dpi: 28 sec
- Connectivity** USB 2.0, Wi-Fi IEEE 802.11b/g/n, Wi-Fi Direct
- Epson Connect** Epson iPrint, Epson Email Print, Remote Print Driver
- Other Mobile Solution** Apple AirPrint, Mopria Print Service, Epson Smart Panel
- Warranty Ink Model** 2 years or 30,000 pages 001

INKTANK PRINTER

Printer Warna Printer Multifungsi untuk Perkantoran / SOHO



L6460



- Printer Type** Print, Scan, Copy with ADF
Technology PrecisionCore™ Printhead
Ink 4 colours pigment Epson Genuine Ink Bottle
Print Resolution 4,800 x 1,200 dpi
(with Variable-Sized Droplet Technology)
Print Speed Up to 37 ppm / 23 ppm
Copy Resolution 600 x 600 dpi
Copy Speed Up to 12 ipm / 6 ppm
Scan Resolution 1,200 x 2,400 dpi
Scan Speed Monochrome 200 dpi: Flatbed 12 ipm / 6 ipm, ADF ; 10 ipm/5 ipm
Colour 200 dpi: 27 sec, ADF : 5 ipm
- Connectivity** USB 2.0, Ethernet, Wi-Fi IEEE 802.11b/g/n, Wi-Fi Direct
- Epson Connect** Epson iPrint, Email Print, Remote Print Driver, Scan to Cloud
- Other Mobile Solution** Apple AirPrint, Mopria Print Service, Epson Smart Panel
- Warranty Ink Model** 2 years or 50,000 pages 008



L6490



- Printer Type** Print, Scan, Copy, Fax with ADF
Technology PrecisionCore™ Printhead
Ink 4 colours pigment Epson Genuine Ink Bottle
Print Resolution 4,800 x 1,200 dpi
(with Variable-Sized Droplet Technology)
Print Speed Up to 37 ppm / 23 ppm
Copy Resolution 600 x 600 dpi
Copy Speed Up to 12 ipm / 6 ppm
Scan Resolution 1,200 x 2,400 dpi
Scan Speed Monochrome 200 dpi: Flatbed 12 ipm / 6 ipm, ADF ; 10 ipm/5 ipm
Colour 200 dpi: 27 sec, ADF : 5 ipm
- Connectivity** USB 2.0, Ethernet, Wi-Fi IEEE 802.11b/g/n, Wi-Fi Direct
- Epson Connect** Epson iPrint, Email Print, Remote Print Driver, Scan to Cloud
- Other Mobile Solution** Apple AirPrint, Mopria Print Service, Epson Smart Panel
- Warranty Ink Model** 2 years or 50,000 pages 008

INKTANK PRINTER

Printer Warna Printer Multifungsi untuk Perkantoran / SOHO

L14150



- Printer Type** Print, Scan, Copy, Fax with ADF
Technology PrecisionCore™ Printhead
Ink 4 Colours Epson Genuine Ink Bottle
Print Resolution 4,800 x 1,200 dpi
Print Speed Up to 38 ppm / 24 ppm
Copy Resolution 600 x 600 dpi
Copy Speed Up to 11.5 ipm / 5.5 ipm
Scan Resolution 1,200 x 2,400 dpi
Scan Speed monochrome, 200 dpi; Flatbed : 13 sec / ADF : 5 ipm
Color, 200 dpi; Flatbed : 28 sec / ADF : 5 ipm
Connectivity USB 2.0, Ethernet, Wi-Fi IEEE 802.11b/g/n, Wi-Fi Direct
Epson Connect Epson iPrint, Epson Email Print, Remote Print Driver, Scan to Cloud
Other Mobile Solution Apple AirPrint, Mopria Print Service, Epson Smart Panel
Warranty Ink Model 2 years or 80,000 pages 001



L15150



- Printer Type** Print, Scan, Copy, Fax with ADF
Technology PrecisionCore™ Printhead
Ink 4 Colours Epson Genuine Ink Bottle
Print Resolution 4800 x 2400 dpi (with Variable-sized Droplet Technology)
Print Speed Approx; 32.0 ppm / 22.0 ppm
Copy Resolution 600 x 600 dpi
Copy Speed 23.0 ipm / 10.0 ipm
Scan Resolution 1200 x 2400 dpi
Scan Speed Black 200 dpi : Flatbed : 5 sec / ADF (Simplex / Duplex) : 26.0 ipm / 11.5 ipm
Colour 200 dpi : Flatbed : 10 sec / ADF (Simplex / Duplex) : 9.0 ipm / 6.0 ipm
Connectivity USB 2.0 Hi-speed, Ethernet, Wi-Fi IEEE 802.11b/g/n, Wi-Fi Direct
Epson Connect Epson iPrint, Email Print, Remote Print Driver, Scan to Cloud
Other Mobile Solutions Apple AirPrint, Mopria Print Service, Epson Smart Panel
Warranty Ink Model 2 years or 80,000 pages 008



INKTANK PRINTER

Printer Warna Printer Multifungsi untuk SOHO / Rumah

L3250



Printer Type	Print, Scan, Copy
Technology	On Demand Inkjet (Piezoelectric)
Ink	4 Colours Epson Genuine Ink Bottle
Print Resolution	5,760 x 1,440 dpi (with Variable-Sized Droplet Technology)
Print Speed	Approx. 33 ppm / 15 ppm
Copy Resolution	600 x 600 dpi
Copy Speed	Up to 7.0 ipm / 1.7 ipm
Scan Resolution	1200 x 2400 dpi
Scan Speed	Monochrome 200 dpi: 11 sec Colour 200 dpi: 28 sec
Connectivity	USB 2.0, Wi-Fi, Wi-Fi Direct
Epson Connect	Epson iPrint, Epson Email Print, Remote Print Driver Epson Smart Panel
Other Mobile Solution	
Warranty	2 years or 30,000 pages
Ink Model	003

L3550



Printer Type	Print, Scan, Copy
Technology	PrecisionCore Printhead
Ink	4 Colours Epson Genuine Ink Bottle
Print Resolution	4,800 x 1,200 dpi (with Variable-Sized Droplet Technology)
Print Speed	up to 33 ppm / 20 ppm
Copy Resolution	600 x 600 dpi
Copy Speed	up to 10.8 ipm / 5.5 ipm
Scan Resolution	1200 x 2400 dpi
Scan Speed	Monochrome 200 dpi: 11 sec Colour 200 dpi: 28 sec
Connectivity	USB 2.0, Wi-Fi IEEE 802.11b/g/n, Wi-Fi Direct
Epson Connect	Epson iPrint, Epson Email Print, Remote Print Driver
Other Mobile Solution	Apple AirPrint, Mopria Print Service, Epson Smart Panel
Warranty	2 years or 50,000 pages
Ink Model	003

L3210



Printer Type	Print, Scan, Copy
Technology	On Demand Inkjet (Piezoelectric)
Ink	4 Colours Epson Genuine Ink Bottle
Print Resolution	5,760 x 1,440 dpi (with Variable-Sized Droplet Technology)
Print Speed	Approx. 33 ppm / 15 ppm
Copy Resolution	600 x 600 dpi
Copy Speed	Up to 7.0 ipm / 1.7 ipm
Scan Resolution	600 x 1,200 dpi
Scan Speed	Monochrome 200 dpi: 11 sec Colour 200 dpi: 32 sec
Connectivity	USB 2.0 Hi-speed
Warranty	2 years or 30,000 pages
Ink Model	003

INKTANK PRINTER

Printer Warna
Printer Foto

INKTANK PRINTER

L8050



Printer Type	Print
Technology	On Demand Inkjet (Piezoelectric)
Ink	6 Colours Epson Genuine Ink Bottle
Print Resolution	5,760 x 1,440 dpi (with Variable-Sized Droplet Technology)
Print Speed	up to 22 ppm / 22 ppm
Connectivity	USB 2.0, Wi-Fi IEEE 802.11b/g/n, Wi-Fi Direct
Epson Connect	Epson iPrint, Epson Email Print, Remote Print Driver
Other Mobile Solution	Epson Smart Panel
Warranty	2 years or 50,000 pages
Ink Model	057

L850



Printer Type	Print, Scan, Copy
Technology	On Demand Inkjet (Piezoelectric)
Ink	6 Colours Epson Genuine Ink Bottle
Print Resolution	5,760 x 1,440 dpi (with Variable-Sized Droplet Technology)
Print Speed	Approx. 37 ppm / 38 ppm
Copy Resolution	N/A
Copy Speed	Approx 37 cpm / 38 cpm
Scan Resolution	1,200 x 2,400 dpi
Scan Speed	Monochrome 300 dpi : 1,6 msec/line Colour 300 dpi : 4,6 msec/line
Connectivity	USB 2.0 Hi-speed
Warranty	1 year or 3,000 photo prints
Ink Model	673

INKTANK PRINTER

Printer Warna Printer Foto

L18050



Printer Type	Print - A3 Size
Technology	On Demand Inkjet (Piezoelectric)
Ink	6 Colours Epson Genuine Ink Bottle
Print Resolution	5,760 x 1,440 dpi (with Variable-Sized Droplet Technology)
Print Speed	up to 22 ppm / 22 ppm
Connectivity	USB 2.0, Wi-Fi IEEE 802.11b/g/n, Wi-Fi Direct
Epson Connect	Epson iPrint, Epson Email Print, Remote Print Driver
Other Mobile Solution	Epson Smart Panel
Warranty	2 years or 50,000 pages
Ink Model	057

Printer Warna Printer Fungsi Tunggal untuk SOHO / Rumah

L121



Printer Type	Print
Technology	on Demand inkjet (piezoelectric)
Ink	4 Colours Epson Genuine Ink Bottle
Print Resolution	720 x 720 dpi (with Variable-Sized Droplet Technology)
Print Speed	up to 9.0 ipm / 4.8 ipm
Connectivity	USB 2.0 Hi-speed
Warranty	2 years or 20,000 pages
Ink Model	664

INKTANK PRINTER

Printer Warna
Printer Fungsi Tunggal untuk SOHO / Rumah



L1210



Printer Type	Print
Technology	on Demand inkjet (piezoelectric)
Ink	4 Colours Epson Genuine Ink Bottle
Print Resolution	5760 x 1440 dpi (with Variable-Sized Droplet Technology)
Print Speed	up to 33.0 ppm / 15.0 ppm
Connectivity	USB 2.0 Hi-speed
Warranty	2 Years or 30,000 pages
Ink Model	003



L1250



Printer Type	Print
Technology	on Demand inkjet (piezoelectric)
Ink	4 Colours Epson Genuine Ink Bottle
Print Resolution	5760 x 1440 dpi (with Variable-Sized Droplet Technology)
Print Speed	up to 33.0 ppm / 15.0 ppm
Connectivity	USB 2.0, Wi-Fi, Wi-Fi Direct
Epson Connect	Epson iPrint, Epson Email Print, Remote Print Driver
Other Mobile Solution	Epson Smart Panel
Warranty	2 Years or 30,000 pages
Ink Model	003

INKTANK PRINTER

Printer Warna
Printer Fungsi Tunggal untuk SOHO / Rumah



L1300



Print (A3+)

Printer Type	Print - A3 Size
Technology	On Demand Inkjet (Piezoelectric)
Ink	4 Colours Epson Genuine Ink Bottle
Print Resolution	5,760 x 1,440 dpi (with Variable-Sized Droplet Technology)
Print Speed	Approx. 30 ppm / 17 ppm
Connectivity	USB 2.0 Hi-speed
Warranty	2 years or 30,000 pages
Ink Model	664



Inkjet Portable Printer

WORKFORCE PRO WF-100



Print



Wi-Fi
Direct



Epson
Connect



Epson
Smart
Panel



Print Tech	Micro Piezo™ Printhead
Print Type	Print (Single Function)
Print Resolution	5,760 x 1,440 dpi (with Variable-Sized Droplet Technology)
Print Speed	Draft, A4 (Black / Colour): Up to 14 ppm / 11 ppm ISO 24734, A4 Simplex (Black / Colour): Up to 7.0 ipm / 4.0 ipm
Paper Size	Legal, Letter, A4, B5, A5, A6, 8x10", 5x7", 4x6", Envelopes: #10, DL, C6
Power Consumption	Operating: Approx 11 W Standby: Approx 4.0 W Sleep: Approx 1.3 W
Connectivity	Hi-Speed USB 2.0, Wi-Fi (IEEE 802.11b/g/n) Wi-Fi Direct
Epson Connect	Epson iPrint, Epson Email Print, Remote Print Driver, Epson Creative Print
Other Mobile Solutions	Apple AirPrint, Google Cloud Print, Mopria Print Service
Consumable	Up to 250 pages* for black ink pack (T289BK) & 200 pages* for color ink pack (T290CL)

INKTANK PRINTER

Printer Monokrom
Printer Multifungsi untuk Perkantoran / SOHO

M3170



red dot award 2019
winner



- Printer Type** Print, Scan, Copy, Fax with ADF
- Technology** PrecisionCore™ Printhead
- Ink** Black Pigment Epson genuine Ink Bottle
- Print Resolution** 1,200 x 2,400 dpi
(with Variable-Sized Droplet Technology)
- Print Speed** Up to 39 ppm
- Copy Speed** Up to 17 ipm
- Scan Resolution** 1,200 x 2,400 dpi
- Scan Speed** Monochrome 200 dpi: 12 sec
Colour 200 dpi: 27 sec
- Connectivity** USB 2.0 Hi-speed, Ethernet, Wi-Fi IEEE 802.11b/g/n, Wi-Fi Direct
- Epson Connect** Epson iPrint, Email Print, Remote Print Driver, Scan to Cloud
- Other Mobile Solution** Apple AirPrint, Google Cloud Print, Morpria Print Service
- Warranty** 4 years or 50,000 pages
- Ink Model** 005

M2140



red dot award 2019
winner



- Printer Type** Print, Scan, Copy
- Technology** PrecisionCore™ Printhead
- Ink** Black Pigment Epson genuine Ink Bottle
- Print Resolution** 1,200 x 2,400 dpi
(with Variable-Sized Droplet Technology)
- Print Speed** Up to 39 ppm
- Copy Resolution** 600 x 600 dpi
- Copy Speed** Up to 17 ipm
- Scan Resolution** 1,200 x 2,400 dpi
- Scan Speed** Monochrome 200 dpi: 12 sec
Colour 200 dpi: 27 sec
- Connectivity** USB 2.0 Hi-speed
- Warranty** 4 years or 50,000 pages
- Ink Model** 005

INKTANK PRINTER

Printer Monokrom
Printer Multifungsi untuk Perkantoran / SOHO

M15140



Printer Type	Print, Scan, Copy, ADF
Technology	PrecisionCore™ Printhead
Ink	Black Pigment Epson genuine Ink Bottle
Print Resolution	4800 x 2400 dpi (with Variable-sized Droplet Technology)
Print Speed	up to 32.0 ppm
Copy resolution	600 x 600 dpi
Copy speed	up to 23.0 ipm
Scan Resolution	1200 x 2400 dpi
Scan Speed	Black 200 dpi : Flatbed : 5 sec / ADF (Simplex / Duplex) : 26.0 ipm / 11.5 ipm
Connectivity	USB 2.0, Ethernet, Wi-Fi IEEE 802.11b/g/n, Wi-Fi Direct
Epson Connect	Epson iPrint, Epson Email Print, Remote Print Driver, Scan to Cloud
Other Mobile Solution	Apple AirPrint, Mopria Print Service, Smart Panel
Warranty	4 years or 150,000 pages
Ink Model	008

M2170



Printer Type	Print, Scan, Copy
Technology	PrecisionCore™ Printhead
Ink	Black Pigment Epson genuine Ink Bottle
Print Resolution	1,200 x 2,400 dpi (with Variable-Sized Droplet Technology)
Print Speed	Up to 39 ppm
Copy Resolution	600 x 600 dpi
Copy Speed	Simplex: Up to 17.0 ipm
Scan Resolution	1,200 x 2,400 dpi
Scan Speed	Monochrome 200 dpi: 12 sec Colour 200 dpi: 27 sec
Connectivity	USB 2.0, Wi-Fi IEEE 802.11b/g/n, Wi-Fi Direct, Ethernet
Epson Connect	Epson iPrint, Epson Email Print, Remote Print Driver
Other Mobile Solution	Apple AirPrint, Mopria Print Service
Warranty	4 years or 50,000 pages
Ink Model	005

INKTANK PRINTER

Printer Monokrom
Printer Fungsi Tunggal untuk Perkantoran / SOHO / Rumah

M1140



red dot award 2019
winner



Printer Type	Print
Technology	PrecisionCore™ Printhead
Ink	Black Pigment Epson genuine Ink Bottle
Print Resolution	1,200 x 2,400 dpi (with Variable-Sized Droplet Technology)
Print Speed	Up to 39 ppm
Connectivity	USB 2.0 Hi-speed
Warranty	4 Years or 50,000 pages
Ink Model	005

M1120



red dot award 2019
winner



Printer Type	Print
Technology	On Demand Inkjet (Piezoelectric)
Ink	Black Pigment Epson genuine Ink Bottle
Print Resolution	1,440 x 720 dpi (with Variable-Sized Droplet Technology)
Print Speed	Up to 32 ppm
Connectivity	USB 2.0 Hi-speed, Wi-Fi IEEE 802.11b/g/n, Wi-Fi Direct
Epson Connect	Epson iPrint, Epson Email Print, Remote Print Driver
Other Mobile Solution	Google Cloud Print
Warranty	4 years or 50,000 pages
Ink Model	005

INKTANK PRINTER

Printer Monokrom
Printer Fungsi Tunggal untuk Perkantoran / SOHO / Rumah



M1100



Printer Type	Print
Technology	On Demand Inkjet (Piezoelectric)
Ink	Black Pigment Epson genuine Ink Bottle
Print Resolution	1,440 x 720 dpi (with Variable-Sized Droplet Technology)
Print Speed	Up to 32 ppm
Connectivity	USB 2.0 Hi-speed
Warranty	4 years or 50,000 pages
Ink Model	005

M1170



Printer Type	Print
Technology	PrecisionCore Printhead
Ink	Black Pigment Epson genuine Ink Bottle
Print Resolution	1,200 x 2,400 dpi (with Variable-Sized Droplet Technology)
Print Speed	up to 39 ppm
Connectivity	USB 2.0, Wi-Fi IEEE 802.11b/g/n, Wi-Fi Direct, Ethernet
Epson Connect	Epson iPrint, Epson Email Print, Remote Print Driver
Other Mobile Solution	Mopria Print Service
Warranty	4 years or 50,000 pages
Ink Model	005



INKTANK PRINTER- 3 Years Warranty



L1211



Print

Printer Type	Print
Technology	on Demand inkjet (piezoelectric)
Ink	4 Colours Epson Genuine Ink Bottle
Print Resolution	5760 x 1440 dpi (with Variable-Sized Droplet Technology)
Print Speed	up to 33.0 ppm / 15.0 ppm
Connectivity	USB 2.0 Hi-speed
Warranty	3 Years or 30,000 pages
Ink Model	003



L1251



Print



Wi-Fi Direct



Epson Connect



Epson Smart Panel

Printer Type	Print
Technology	on Demand inkjet (piezoelectric)
Ink	4 Colours Epson Genuine Ink Bottle
Print Resolution	5760 x 1440 dpi (with Variable-Sized Droplet Technology)
Print Speed	up to 33.0 ppm / 15.0 ppm
Connectivity	USB 2.0 Hi Speed, Wi-Fi, Wi-Fi Direct
Epson Connect	Epson iPrint, Epson Email Print, Remote Print Driver
Other Mobile Solution	Epson Smart Panel
Warranty	3 Years or 30,000 pages
Ink Model	003



L3211



Print



Scan



Copy

Printer Type	Print, Scan, Copy
Technology	On Demand Inkjet (Piezoelectric)
Ink	4 Colours Epson Genuine Ink Bottle
Print Resolution	5,760 x 1,440 dpi (with Variable-Sized Droplet Technology)
Print Speed	Approx. 33 ppm / 15 ppm
Copy Resolution	600 x 600 dpi
Copy Speed	Up to 7.0 ipm / 1.7 ipm
Scan Resolution	600 x 1,200 dpi
Scan Speed	Monochrome 200 dpi: 11 sec Colour 200 dpi: 32 sec
Connectivity	USB 2.0 Hi-speed
Warranty	3 years or 30,000 pages
Ink Model	003

INKTANK PRINTER- 3 Years Warranty



L3251



- Printer Type** Print, Scan, Copy
Technology On Demand Inkjet (Piezoelectric)
Ink 4 Colours Epson Genuine Ink Bottle
Print Resolution 5,760 x 1,440 dpi
(with Variable-Sized Droplet Technology)
Print Speed Approx. 33 ppm / 15 ppm
Copy Resolution 600 x 600 dpi
Copy Speed Up to 7.7 ipm / 3.8 ipm
Scan Resolution 1200 x 2400 dpi
Scan Speed Monochrome 200 dpi: 11 sec
Colour 200 dpi: 28 sec
Connectivity USB 2.0, Wi-Fi, Wi-Fi Direct
Epson Connect Epson iPrint, Epson Email Print, Remote Print Driver
Epson Smart Panel Epson Smart Panel
Other Mobile Solution 3 years or 30,000 pages
Warranty Ink Model 003



L4261



- Printer Type** Print, Scan, Copy
Technology On Demand Inkjet (Piezoelectric)
Ink 4 Colours Epson Genuine Ink Bottle
Print Resolution 5,760 x 1,440 dpi
(with Variable-Sized Droplet Technology)
Print Speed Up to 33 ppm / 15 ppm
Copy Resolution 600 x 600 dpi
Copy Speed Up to 7.7 ipm / 3.8 ipm
Scan Resolution 1,200 x 2,400 dpi
Scan Speed Monochrome 200 dpi: 11 sec
Colour 200 dpi: 28 sec
Connectivity USB 2.0, Wi-Fi IEEE 802.11b/g/n, Wi-Fi Direct
Epson Connect Epson iPrint, Epson Email Print, Remote Print Driver
Epson Smart Panel Epson Smart Panel
Other Mobile Solution Apple AirPrint, Mopria Print Service,
Warranty Ink Model 3 years or 30,000 pages
001

INKTANK PRINTER (Available Only In Epson Official Store)

L1216



Print



Printer Type	Print
Technology	on Demand inkjet (piezoelectric)
Ink	4 Colours Epson Genuine Ink Bottle
Print Resolution	5760 x 1440 dpi (with Variable-Sized Droplet Technology)
Print Speed	up to 33.0 ppm / 15.0 ppm
Connectivity	USB 2.0 Hi-speed
Warranty	2 Years or 30,000 pages
Ink Model	003

L1256



Print



Wi-Fi Direct

Epson Connect

Epson Smart Panel



Printer Type	Print
Technology	on Demand inkjet (piezoelectric)
Ink	4 Colours Epson Genuine Ink Bottle
Print Resolution	5760 x 1440 dpi (with Variable-Sized Droplet Technology)
Print Speed	up to 33.0 ppm / 15.0 ppm
Connectivity	USB 2.0, Wi-Fi, Wi-Fi Direct
Epson Connect	Epson iPrint, Epson Email Print, Remote Print Driver
Other Mobile Solution	Epson Smart Panel
Warranty	2 Years or 30,000 pages
Ink Model	003

L3216



Print



Scan

Copy



Printer Type	Print, Scan, Copy
Technology	On Demand Inkjet (Piezoelectric)
Ink	4 Colours Epson Genuine Ink Bottle
Print Resolution	5,760 x 1,440 dpi (with Variable-Sized Droplet Technology)
Print Speed	Approx. 33 ppm / 15 ppm
Copy Resolution	600 x 600 dpi
Copy Speed	Up to 7.0 ipm / 1.7 ipm
Scan Resolution	600 x 1,200 dpi
Scan Speed	Monochrome 200 dpi: 11 sec Colour 200 dpi: 32 sec
Connectivity	USB 2.0 Hi-speed
Warranty	2 years or 30,000 pages
Ink Model	003

INKTANK PRINTER (Available Only In Epson Official Store)

L3256



Printer Type
Technology
Ink
Print Resolution

Print Speed
Copy Resolution
Copy Speed
Scan Resolution
Scan Speed

Connectivity
Epson Connect

Other Mobile Solution
Warranty
Ink Model

Print, Scan, Copy
On Demand Inkjet (Piezoelectric)
4 Colours Epson Genuine Ink Bottle
5,760 x 1,440 dpi
(with Variable-Sized Droplet Technology)
Approx. 33 ppm / 15 ppm
600 x 600 dpi
Up to 7.0 ipm / 1.7 ipm
1200 x 2400 dpi
Monochrome 200 dpi: 11 sec
Colour 200 dpi: 28 sec
USB 2.0, Wi-Fi, Wi-Fi Direct
Epson iPrint, Epson Email Print,
Remote Print Driver
Epson Smart Panel
2 years or 30,000 pages
003

L3556



Printer Type
Technology
Ink
Print Resolution

Print Speed
Copy Resolution
Copy Speed
Scan Resolution
Scan Speed

Connectivity
Epson Connect

Other Mobile Solution
Warranty
Ink Model

Print, Scan, Copy
PrecisionCore Printhead
4 Colours Epson Genuine Ink Bottle
4,800 x 1,200 dpi
(with Variable-Sized Droplet Technology)
Approx. 33 ppm / 20 ppm
600 x 600 dpi
up to 10.8 ipm / 5.5 ipm
1200 x 2400 dpi
Monochrome 200 dpi: 11 sec
Colour 200 dpi: 28 sec
USB 2.0, Wi-Fi IEEE 802.11b/g/n, Wi-Fi Direct
Epson iPrint, Epson Email Print,
Remote Print Driver
Epson Smart Panel
2 years or 50,000 pages
003

L5296



Printer Type
Technology
Ink
Print Resolution

Print Speed
Copy Resolution
Copy Speed
Scan Resolution
Scan Speed

Connectivity
Epson Connect

Other Mobile Solution
Warranty
Ink Model

Print, Scan, Copy, Fax with ADF
On Demand Inkjet (Piezoelectric)
4 Colours Epson Genuine Ink Bottle
5,760 x 1,440 dpi
(with Variable-Sized Droplet Technology)
Approx. 33 ppm / 15 ppm
600 x 600 dpi
Up to 7.7 ipm / 3.8 ipm
1,200 x 2,400 dpi
Monochrome - Flatbed : 12 sec / ADF : 4.5 ipm
Colour - Flatbed : 29 sec / ADF : 4.5 ipm
USB 2.0, Ethernet, Wi-Fi IEEE 802.11b/g/n,
Wi-Fi Direct
Epson iPrint, Epson Email Print, Remote Print
Driver
Apple AirPrint, Mopria Print Service,
Epson Smart Panel
2 years or 30,000 pages
003

INK CONSUMABLES



SINGLE-FUNCTION INKJET PRINTER	T664 series	003 series	001 series	008 series	T673 series	057 series	T7741	005
L100/L110/L120	●							
L300/L310	●							
L121	●							
L1110		●						
L1210/L1216/ L1211		●						
L1250/L1256/ L1251		●						
L1300	●							
MULTI-FUNCTION INKJET PRINTER	T664 series	003 series	001 series	008 series	T673 series	057 series	T7741	005
L200/L210/L220	●							
L350/L360/L380	●							
L355/L365/L385	●							
L550/L555/L565	●							
L455/L485	●							
L605/L655	●						●	
L1455	●						●	
L3110/L3116		●						
L3150/L3156		●						
L3210/L3216/ L3211		●						
L3250/L3256/ L3251		●						
L3550/L3556		●						
L4150/L4160			●					
L4260/L4261			●					
L5190		●						
L5290/L5296		●						
L5590		●						
L6160/L6170/ L6190			●					
L6260/L6270/ L6290			●					
L6460				●				
L6490				●				
L14150			●					
L15150				●				
PHOTO INKJET PRINTER	T664 series	003 series	001 series	008 series	T673 series	057 series	T7741	005
L800/L805					●			
L8050						●		
L850					●			
L1800					●			
L18050						●		

INK CONSUMABLES



MONOCHROME INKJET PRINTER	T664 series	003 series	001 series	008 series	T673 series	057 series	T7741	005
M100/M200							●	
M1100								●
M1120								●
M1140								●
M1170								●
M2140								●
M2170								●
M3170								●
M15140				●				

Epson Claria™ Photographic Ink



Photo Inkjet Printer

Picture Pack T585290

Epson PictureMate® PM235/310
Epson PictureMate® PM210/215
Epson PictureMate® PM250/270

■
■
■

DURABrite Ultra Inks

Ink Code

Epson WorkForce WF-7111 / WF-7611	T188 Series
Epson WorkForce WF-100	C13T289190 Blk Ink (Pigment)
	C13T290090 Ctr Ink (Pigment)
Epson Stylus® Office T1100 Epson WF Pro WF3521 Epson WF Pro WF7511/WF7011	143 [Extra High Cap]

List Maintenance Box for Consumer Product

(Lseries, Mseries & Other Model)

MATERIAL CODE	DESCRIPTION	COMPATIBILITY			
		Lseries	Mseries	Others	
C13T295000	WF-100 Maintenance Box			WF-100	
C13T295100	Maintenance box PM-520			PictureMate PM 520	
C13T671000	MAINTENANCE BOX			WP-4011	
				WP-4511	
				WP-4521	
				WF-5111	
				WF-5621	
C13T671100	MAINTENANCE BOX	L1455		WF-3011	
				WF-3521	
				WF-7211	
				WF-7711	
			L6160	M1140	
			L6170	M1170	
C13T04D100	MAINTENANCE BOX	L6190	M2140		
		L6260	M2170		
		L6270	M3170		
		L6290			
		L6460			
		L6490			
C12C934591	MAINTENANCE BOX	L15150	M15140		
		L3550			
		L5590			
C12C934461	MAINTENANCE BOX	L3556			
		L8050			
C12C937771	Pickup Roller	L18050			

BUSINESS INKJET PRINTER



BUSINESS INKJET PRINTER

MENGAPA MEMILIH BUSINESS INKJET PRINTER ?

Epson business inkjet printers menghadirkan kualitas yang luar biasa, kecepatan sangat cepat, handal dan kinerja yang optimal untuk memenuhi kebutuhan bisnis Anda.

Revolutionary Compact PrecisionCore Linehead Design

Advanced built-in Nozzle Verification Technology memonitor kondisi nozzle dan kualitas cetak menyesuaikan secara otomatis tanpa interupsi, bahkan selama pencetakan.



Heat-Free Technology

Teknologi Heat-Free tidak membutuhkan panas dalam proses pengeluaran tinta. Sebaliknya tekanan diterapkan pada Piezo Element, yang melentur ke belakang dan meneruskan tinta dari printhead ke depan.



The Ecological Choice

Lakukan lebih banyak untuk bisnis Anda dan tetap lebih ramah lingkungan. Beralih ke Epson inkjet printer dan lihat bagaimana Anda dapat meningkatkan produktivitas yang lebih tinggi dan menurunkan emisi berbahaya dalam sehari-hari.

Printer inkjet kami menggunakan daya lebih kecil dari printer laser lainnya sehingga Anda tidak hanya peduli terhadap lingkungan, tetapi Anda menghemat biaya juga.

Jumlah karbon dioksida yang dipancarkan oleh laser printer akan membutuhkan hingga 8 pohon untuk menyerap semua karbon dioksida sedangkan printer inkjet Epson hanya butuh 1 pohon.

Part yang terbuang dari Printer inkjet lebih sedikit dibandingkan printer laser.

Epson Inkjet Printers Up to **85%** less power consumption* VS Laser Printers

Epson Inkjet Printers Up to **85%** less CO₂ generated* VS Laser Printers

Epson Inkjet Printers Up to **59%** less replacement parts* VS Laser Printers

BUSINESS INKJET PRINTER

Single Function Printer A4

WORKFORCE PRO WF-5390



Print Tech	PrecisionCore™ Printhead
Print Type	Print (Single Function)
Print Resolution	4,800 x 1,200 dpi [with Variable-Sized Droplet Technology]
Print Speed	Up to 34 ppm / 34 ppm (Black#1 / Colour#2) - Draft Text - Memo (A4) Up to 24 ipm / 24 ipm (Black / Colour) - ISO 24734, A4, Simplex Up to 15 ipm / 15 ipm (Black / Colour) - ISO 24734, A4, Duplex
Paper Size	A4, 8.5x13", Legal, Letter, Executive, B5, A5, A6, B6, 5x7", 16:9 wide, 4x6", Envelopes: #10, DL, C6, C4
Power Consumption	Operating: 22 Watt Standby: 7 Watt Sleep: 1.2 Watt
Connectivity	USB 2.0, Ethernet, Wi-Fi (IEEE 802.11b/g/n), Wi-Fi Direct, NFC
Epson Connect	Epson iPrint, Epson Email Print, Remote Print Driver
Other Mobile Solutions	Apple AirPrint, Google Cloud Print, Mopria Print Service
Consumable	Up to 10,000 pages* for black ink pack & 3,000 pages* for color ink pack

Multi Function Printer A4

WORKFORCE PRO WF-C5890



Print Tech	PrecisionCore™ Printhead
Print Type	Print, Scan, Copy, Fax with ADF
Print Resolution	4,800 x 1,200 dpi [with Variable-Sized Droplet Technology]
Print Speed	Up to 34 ppm / 34 ppm (Black#1 / Colour#2) - Draft Text - Memo (A4) Up to 24 ipm / 24 ipm (Black / Colour) - ISO 24734, A4, Simplex Up to 15 ipm / 15 ipm (Black / Colour) - ISO 24734, A4, Duplex
Copy Speed	Up to 22 ipm / 22 ipm (Black / Colour) - ISO 29183, A4, Simplex Up to 22 ipm / 22 ipm (Black / Colour) - ISO 24735, A4, 1:1
Scan Speed	Monochrome 200 dpi: Flatbed / ADF (simplex) / ADF (duplex), 5 sec / 24 ppm / 8 ipm Colour 200 dpi: Flatbed / ADF (simplex) / ADF (duplex), 5 sec / 24 ppm / 8 ipm
Scan Resolution	1,200 x 2,400 dpi
Paper Size	A4, 8.5x13", Legal, Letter, Executive, B5, A5, A6, B6, 5x7", 16:9 wide, 4x6", Envelopes: #10, DL, C6, C4
Power Consumption	Operating: 25 Watt Standby: 12 Watt Sleep: 1.5 Watt
Connectivity	USB 2.0, Ethernet, Wi-Fi (IEEE 802.11b/g/n), Wi-Fi Direct, NFC
Epson Connect	Epson iPrint, Epson Email Print, Remote Print Driver, Scan to Cloud
Other Mobile Solutions	Apple AirPrint, Google Cloud Print, Mopria Print Service
Consumable	Up to 10,000 pages* for black ink pack & 3,000 pages* for color ink pack

BUSINESS INKJET PRINTER

Multi Function Printer A4



WORKFORCE PRO WF-C579R



reddot award 2019
winner



Print Tech	PrecisionCore™ Printhead
Print Type	Print, Scan, Copy, Fax with ADF
Print Resolution	4,800 x 1,200 dpi
Print Speed	[with Variable-Sized Droplet Technology] Up to 34 ppm / 34 ppm [Black#1 / Colour#2] - Draft Text - Memo (A4) Up to 24 ipm / 24 ipm [Black / Colour] - ISO 24734, A4, Simplex Up to 22 ipm / 22 ipm [Black / Colour] - ISO 29183, A4, Simplex
Copy Speed	Up to 22 ipm / 22 ipm [Black / Colour] - ISO 29183, A4, Simplex Up to 22 ipm / 22 ipm [Black / Colour] - ISO 24735, A4, 1:1
Scan Speed	Monochrome 200 dpi: 5 sec (flatbed, A4 Landscape) Colour 200 dpi: 5 sec (flatbed, A4 Landscape) ADF (duplex), 5 sec / 24 ppm / 8 ipm
Scan Resolution	1,200 x 2,400 dpi
Paper Size	A4, 8.5x13", Legal, Letter, Executive, B5, A5, A6, B6, 5x7", 16:9 wide, 4x6", Envelopes: #10, DL, C6, C4
Power Consumption	Operating: 29 Watt Standby: 14 Watt Sleep: 1.3 Watt
Connectivity	USB 2.0, Ethernet, Wi-Fi (IEEE 802.11b/g/n), Wi-Fi Direct
Epson Connect	Epson iPrint, Epson Email Print, Remote Print Driver, Scan to Cloud
Other Mobile Solutions	Apple AirPrint, Google Cloud Print, Mopria Print Service
Consumable	Up to 50,000 pages* ink packs

L6550



Printer Type	Print, Scan, Copy, Fax with ADF
Technology	PrecisionCore™ Printhead
Print Resolution	4,800 x 2,400 dpi
Print Speed	Up to 32 ppm / 22 ppm 25/12 ipm (ISO doc)
Copy Resolution	600 x 600 dpi
Copy Speed	Up to 23 ipm / 10 ipm
Scan Resolution	1,200 x 2,400 dpi
Scan Speed	Monochrome: 200dpi Up to 5.0sec / 27.5 ppm / 11 ipm Colour: 200dpi Up to 10sec / 9.0 ppm / 6.0 ipm
Connectivity	USB 2.0, Ethernet (100BASE-TX/10BASE-T), Wi-Fi (IEEE 802.11 b/g/n), Wi-Fi Direct
Epson Connect	Epson iPrint, Epson Email Print, Remote Print Driver, Scan to Cloud
Other Mobile Solution	Apple AirPrint, Mopria Print Service
Ink Model	008

BUSINESS INKJET PRINTER

Multifunction Printer A4

L6580



Printer Type	Print, Scan, Copy, Fax with ADF
Technology	PrecisionCore™ Printhead
Ink	4 Colours Epson Genuine Ink Bottle
Print Resolution	4,800 x 1,200 dpi
Print Speed	Up to 32 ppm / 32 ppm 25/25 ipm (ISO doc)
Copy Resolution	600 x 600 dpi
Copy Speed	Up to 23 ipm / 23 ipm
Scan Resolution	1,200 x 2,400 dpi
Scan Speed	Monochrome: 5 sec / Up to 27.5 ipm / 11.5 ipm Colour: 10 sec / Up to 9.0 ipm 6.0 ipm
Connectivity	USB 2.0, Ethernet (100BASE-TX/10BASE-T), Wi-Fi (IEEE 802.11 b/g/n), Wi-Fi Direct
Epson Connect	Epson iPrint, Epson Email Print, Remote Print Driver, Scan to Cloud
Other Mobile Solution	Apple AirPrint, Mopria Print Service
Ink Model	008

Multifunction Printer A3

L15160



Printer Type	Print, Scan, Copy, Fax with ADF
Technology	PrecisionCore™ Printhead
Ink	4 Colours Epson Genuine Ink Bottle
Print Resolution	4,800 x 2,400 dpi
Print Speed	Up to 32 ppm / 32 ppm 25/21 ipm (ISO doc)
Copy Resolution	600 x 600 dpi
Copy Speed	Up to 23 ipm / 23 ipm
Scan Resolution	1,200 x 2,400 dpi
Scan Speed	Black: 5 sec / Up to 26.0 ipm 11.5 ipm Colour: 10 sec / Up to 9.0 ipm 6.0 ipm
Connectivity	USB 2.0, Ethernet, Wi-Fi IEEE 802.11 b/g/n, Wi-Fi Direct
Epson Connect	Epson iPrint, Epson Email Print, Remote Print Driver, Scan to Cloud
Other Mobile Solution	Apple AirPrint, Mopria Print Service
Warranty	2 years or 80,000 prints
Ink Model	008

BUSINESS INKJET PRINTER

Multifunction Printer A3

L15180



Printer Type	Print, Scan, Copy, Fax with ADF
Technology	PrecisionCore™ Printhead
Ink	4 Colours Epson Genuine Ink Bottle
Print Resolution	4,800 x 1,200 dpi
Print Speed	Up to 32 ppm / 32 ppm 25/21 ipm (ISO doc)
Copy Resolution	600 x 600 dpi
Copy Speed	Up to 23 ipm / 23 ipm
Scan Resolution	1,200 x 2,400 dpi
Scan Speed	Black: 5 sec / Up to 26.0 ipm 11.5 ipm Colour: 10 sec / Up to 9.0 ipm 6.0 ipm
Connectivity	USB 2.0, Ethernet, Wi-Fi IEEE 802.11 b/g/n, Wi-Fi Direct
Epson Connect	Epson iPrint, Epson Email Print, Remote Print Driver, Scan to Cloud
Other Mobile Solution	Apple AirPrint, Mopria Print Service
Warranty	2 years or 80,000 prints
Ink Model	008

Monochrome Multifunction Printer A3

M15180

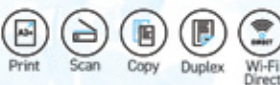

Printer Type	Print, Scan and Copy with ADF
Technology	PrecisionCore™ Printhead
Ink	Black
Print Resolution	4,800 x 2,400 dpi
Print Speed	Up to 32 ppm / 32 ppm 25/16 ipm (ISO doc)
Copy Resolution	600 x 600 dpi
Copy Speed	Up to 23 ipm / 23 ipm
Scan Resolution	1,200 x 2,400 dpi
Scan Speed	Black: 5 sec / Up to 26.0 ipm 11.5 ipm Colour: 10 sec / Up to 9.0 ipm 6.0 ipm
Connectivity	USB 2.0, Ethernet, Wi-Fi IEEE 802.11 b/g/n, Wi-Fi Direct
Epson Connect	Epson iPrint, Epson Email Print, Remote Print Driver, Scan to Cloud
Other Mobile Solution	Apple AirPrint, Mopria Print Service
Warranty	2 years or 80,000 prints
Ink Model	008

BUSINESS INKJET PRINTER

Multifunction Printer A3

WORKFORCE PRO WF-C878R



Print Method	PrecisionCore™ Print Head
Max Resolution	4,800 x 1,200 dpi (with Variable-Sized Droplet Technology)
Min Droplet Size	4.6 pl
Print Speed	Max Draft Text - Memo (A4) : Approx. 35 ppm / 35 ppm (Black / Colour) ISO 24734, A4, Simplex : Approx. 25 ipm / 24 ipm (Black / Colour) ISO 24734, A4, Duplex : Approx. 17 ipm / 16 ipm (Black / Colour) ISO 24734.2, A3, Simplex : Approx. 13 ipm / 13 ipm (Black / Colour) ISO 24734.2, A3, Duplex : Approx. 11 ipm / 11 ipm (Black / Colour)
Copy Resolution	600 x 600 dpi
Copy Speed	ISO 29183, A4, Simplex (Flatbed) Approx. 23 ipm / 22 ipm (Black / Colour) ISO 24735, A4, Simplex (ADF) Approx. 21 ipm / 21 ipm (Black / Colour) ISO 24735, A4, Duplex (ADF) Approx. 15 ipm / 15 ipm (Black / Colour)
Scan Resolution	1,200 x 2,400 dpi
Scan Speed	[A4 Landscape, Flatbed / ADF Simplex / ADF Duplex] Monochrome 200 dpi: 4.0 sec / 25 ppm / 45 ipm Colour 200 dpi: 5.0 sec / 25 ppm / 45 ipm
Memory	3,072 MB

WORKFORCE PRO WF-C879R



Print Method	PrecisionCore™ Print Head
Max Resolution	4,800 x 1,200 dpi (with Variable-Sized Droplet Technology)
Min Droplet Size	4.6 pl
Print Speed	Max Draft Text - Memo (A4) : Approx. 35 ppm / 35 ppm (Black / Colour) ISO 24734, A4, Simplex : Approx. 26 ipm / 25 ipm (Black / Colour) ISO 24734, A4, Duplex : Approx. 18 ipm / 17 ipm (Black / Colour) ISO 24734.2, A3, Simplex : Approx. 13 ipm / 13 ipm (Black / Colour) ISO 24734.2, A3, Duplex : Approx. 11 ipm / 11 ipm (Black / Colour)
Copy Resolution	600 x 600 dpi
Copy Speed	ISO 29183, A4, Simplex (Flatbed) : Approx. 24 ipm / 23 ipm (Black / Colour)
Scan Resolution	600 x 600 dpi
Scan Speed	[A4 Landscape, Flatbed / ADF Simplex / ADF Duplex] Monochrome 200 dpi: 3.7 sec / 50 ppm / 100 ipm Colour 200 dpi: 3.7 sec / 50 ppm / 100 ipm
Memory	4,224 MB

BUSINESS INKJET PRINTER

WORKFORCE ENTERPRISE AM-C4000

NEW
PRODUCT



Print Tech	PrecisionCore Line Head Inkjet Technology
Print Type	Print, Scan, Copy, Fax
Print Resolution	600 x 2,400 dpi
Print Speed	Approx. 40 ipm / 40 ipm (Black/ Colour) - ISO 24734, A4, Simplex / Duplex Approx. 23 ipm / 11 ipm (Black/ Colour) - ISO 24734.2, A3, Simplex / Duplex Approx. 7.6 sec / 7.6 sec (Black/ Colour) - First Page Out Time
Copy Speed	Approx. 40 ipm (Black and Colour) - ISO 29183, A4, Simplex (Flatbed) Approx. 40 ipm / 40 ipm (Black/ Colour) - ISO 24735, A4, Simplex (ADF 1:1) Approx. 40 ipm / 40 ipm (Black/ Colour) - ISO 24735, A4, Duplex (ADF 1:2 / 2:2)
Scan Speed	A4 Landscape: 3.0 sec, A3: 4.0 sec, A4: 60 ppm / 120 ipm A3: 30 ppm / -
Scan Resolution	600 x 600 dpi
Paper Size	A3+, A3, A4, B5, A5, A6, 5x7", 4x6", Legal, 8.5x13", Letter, Envelopes: #10, DL, C6, C5, C4
Power Consumption	Operating: 110 Watt, Standby: 46 Watt, Sleep: 1.0 Watt
Connectivity	USB 3.0, Ethernet, Ethernet, Direct Wi-Fi, Fax, Storage with HDD
Epson Connect	Epson iPrint, Epson Email Print, Remote Print Driver, Scan to Cloud
Other Mobile Solutions	Apple AirPrint, Mopria Print Service, Microsoft Universal Print
Consumable	Up to 50,000 pages *for blank ink pack

WORKFORCE ENTERPRISE AM-C5000

NEW
PRODUCT



Print Tech	PrecisionCore Line Head Inkjet Technology
Print Type	Print, Scan, Copy, Fax
Print Resolution	600 x 2,400 dpi
Print Speed	Approx. 50 ipm / 50 ipm (Black/ Colour) - ISO 24734, A4, Simplex / Duplex Approx. 30 ipm / 15 ipm (Black/ Colour) - ISO 24734.2, A3, Simplex / Duplex Approx. 6.7 sec / 6.7 sec (Black/ Colour) - First Page Out Time
Copy Speed	Approx. 50 ipm (Black and Colour) - ISO 29183, A4, Simplex (Flatbed) Approx. 50 ipm / 50 ipm (Black/ Colour) - ISO 24735, A4, Simplex (ADF 1:1) Approx. 50 ipm / 50 ipm (Black/ Colour) - ISO 24735, A4, Duplex (ADF 1:2 / 2:2)
Scan Speed	A4 Landscape: 3.0 sec, A3: 4.0 sec, A4: 60 ppm / 120 ipm A3: 30 ppm / -
Scan Resolution	600 x 600 dpi
Paper Size	A3+, A3, A4, B5, A5, A6, 5x7", 4x6", Legal, 8.5x13", Letter, Envelopes: #10, DL, C6, C5, C4
Power Consumption	Operating: 110 Watt, Standby: 46 Watt, Sleep: 1.0 Watt
Connectivity	USB 3.0, Ethernet, Ethernet, Direct Wi-Fi, Fax, Storage with HDD
Epson Connect	Epson iPrint, Epson Email Print, Remote Print Driver, Scan to Cloud
Other Mobile Solutions	Apple AirPrint, Mopria Print Service, Microsoft Universal Print
Consumable	Up to 50,000 pages *for blank ink pack

BUSINESS INKJET PRINTER

Multifunction Printer A3

WORKFORCE ENTERPRISE AM-C6000

**NEW
PRODUCT**



Print Tech	PrecisionCore Line Head Inkjet Technology
Print Type	Print, Scan, Copy, Fax
Print Resolution	600 x 2,400 dpi
Print Speed	Approx. 60 ipm / 60 ipm (Black/ Colour) - ISO 24734, A4, Simplex / Duplex Approx. 36 ipm / 20 ipm (Black/ Colour) - ISO 24734.2, A3, Simplex / Duplex Approx. 6.1 sec / 6.1 sec (Black/ Colour) - First Page Out Time
Copy Speed	Approx. 60 ipm (Black and Colour) - ISO 29183, A4, Simplex (Flatbed) Approx. 60 ipm / 60 ipm (Black/ Colour) - ISO 24735, A4, Simplex (ADF 1:1) Approx. 60 ipm / 60 ipm (Black/ Colour) - ISO 24735, A4, Duplex (ADF 1:2 / 2:2)
Scan Speed	A4 Landscape: 3.0 sec, A3: 4.0 sec, A4: 60 ppm / 120 ipm A3: 30 ppm / -
Scan Resolution	600 x 600 dpi
Paper Size	A3+, A3, A4, B5, A5, A6, 5x7", 4x6", Legal, 8.5x13", Letter, Envelopes: #10, DL, C6, C5, C4
Power Consumption	Operating: 110 Watt, Standby: 46 Watt, Sleep: 1.0 Watt
Connectivity	USB 3.0, Ethernet, Ethernet, Direct Wi-Fi, Fax, Storage with HDD
Epson Connect	Epson iPrint, Epson Email Print, Remote Print Driver, Scan to Cloud
Other Mobile Solutions	Apple AirPrint, Mopria Print Service, Microsoft Universal Print
Consumable	Up to 50,000 pages* for blank ink pack

WORKFORCE PRO WF-C20750



Print Tech	PrecisionCore™ Linehead Inkjet Technology
Print Type	Print, Scan, Copy, Fax
Print Resolution	600 x 2,400 dpi
Print Speed	Approx. 75 ipm / 75 ipm (Black / Colour) - ISO 24734, A4, Simplex / Duplex Approx. 45 ipm / 25.4 ipm (Black / Colour) - ISO 24734.2, A3, Simplex / Duplex Approx. 5.5 sec / 5.5 sec (Black / Colour) - ISO First Page Out Time
Copy Speed	Approx. 75 ipm (Black / Colour) - ISO 29183, A4, Simplex (Flatbed) Approx. 75 ipm (Black / Colour) - ISO 24735, A4, Simplex (ADF 1:1) Approx. 75 ipm (Black / Colour) - ISO 24735, A4, Duplex (ADF 1:2 / 2:2)
Scan Speed	3.7 sec / 60 ppm / 110 ppm (200 dpi; Mono / Colour)
Scan Resolution	600 x 1,200 dpi
Paper Size	A3+, A3, A4, B5, A5, A6, 5x7", 4x6", Legal, 8.5x13", Letter, Envelopes: #10, DL, C6, C5, C4
Power Consumption	Operating: 160 Watt Standby: 77 Watt Sleep: 1.4 Watt
Connectivity	USB 3.0, Ethernet (1000BASE-T/100BASE-TX/10BASE-T), Wi-Fi (IEEE 802.11b/g/n), Wi-Fi Direct, NFC
Epson Connect	Epson iPrint, Epson Email Print, Remote Print Driver, Scan to Cloud
Other Mobile Solutions	Google Cloud Print, Mopria Print Service
Consumable	Up to 100,000 pages* for black ink pack

BUSINESS INKJET PRINTER

WORKFORCE PRO WF-C21000



Print Tech	PrecisionCore™ Linehead Inkjet Technology
Print Type	Print, Scan, Copy, Fax
Print Resolution	600 x 2,400 dpi
Print Speed	Approx. 100 ipm / 100 ipm [Black / Colour] - ISO 24734, A4, Simplex / Duplex Approx. 54 ipm / 36.3 ipm [Black / Colour] - ISO 24734.2, A3, Simplex / Duplex Approx. 5.0 sec / 5.0 sec [Black / Colour] - First Page Out Time
Copy Speed	Approx. 100 ipm [Black / Colour] - ISO 29183, A4, Simplex (Flatbed) Approx. 100 ipm [Black / Colour] - ISO 24735, A4, Simplex (ADF 1:1) Approx. 100 ipm [Black / Colour] - ISO 24735, A4, Duplex (ADF 1:2 / 2:2)
Scan Speed	3.7 sec / 60 ppm / 110 ppm (200 dpi; Mono / Colour)
Scan Resolution	600 x 1,200 dpi
Paper Size	A3+, A3, A4, B5, A5, A6, 5x7", 4x6", Legal, 8.5x13", Letter, Envelopes: #10, DL, C6, C5, C4
Power Consumption	Operating: 170 Watt Standby: 77 Watt Sleep: 1.4 Watt
Connectivity	USB 3.0, Ethernet (1000BASE-T/100BASE-TX/10BASE-T), Wi-Fi (IEEE 802.11b/g/n), Wi-Fi Direct, NFC
Epson Connect	Epson iPrint, Epson Email Print, Remote Print Driver, Scan to Cloud
Other Mobile Solutions	Apple AirPrint, Google Cloud Print, Mopria Print Service
Consumable	Up to 100,000 pages* for black ink pack

Monochrome Multifunction Printer A3

WORKFORCE PRO WF-M21000



Print Tech	PrecisionCore™ Linehead Inkjet Technology
Print Type	Print, Scan, Copy, Fax
Print Resolution	600 x 2,400 dpi
Print Speed	Approx. 100 ipm / 100 ipm [Black] - ISO 24734, A4, Simplex / Duplex Approx. 54 ipm / 36.3 ipm [Black] - ISO 24734.2, A3, Simplex / Duplex Approx. 5.0 sec / 5.0 sec [Black] - First Page Out Time
Copy Speed	Approx. 100 ipm / 100 ipm [black] - ISO 29183, A4, Simplex (Flatbed) Approx. 100 ipm / 100 ipm [black] - ISO 24735, A4, Simplex (ADF, 1:1)
Scan Speed	3.7 sec / 60 ppm / 110 ppm (200 dpi; Mono / Colour)
Scan Resolution	600 x 600 dpi
Paper Size	A3+, A3, A4, B5, A5, A6, 5x7", 4x6", Legal, 8.5x13", Letter, Envelopes: #10, DL, C6, C5, C4
Power Consumption	Operating: 180 Watt Standby: 77 Watt Sleep: 1.4 Watt
Connectivity	USB 3.0, Ethernet (1000BASE-T/100BASE-TX/ 10BASE-T), Wi-Fi (IEEE 802.11b/g/n), Wi-Fi Direct, NFC
Epson Connect	Epson iPrint, Epson Email Print, Remote Print Driver, Scan to Cloud
Other Mobile Solutions	Google Cloud Print, Mopria Print Service
Consumable	Up to 100,000 pages* for black ink pack

BUSINESS INKJET PRINTER

T-Series Surecolor Technical Series

SURECOLOR SC-T3730E



Max Print Width	24 inch wide (borderless)
Print Head	2.64 MicroTFP
Max Resolution	2401 dpi x 1200 dpi
Min Droplet Size	3.5 pl
Ink System	Ultrachrome XD3 pigment ink
Type	All Pigment Aqueous
Colours	C+M+Y+R+MK+PK (Black Matte/Photo Black)
Cartridge Size	110/350/700 ml
Paper Size	Spindle-less front loading single roll [Roll: 0.07mm – 0.8mm, Cut Sheet: 0.07mm – 0.8mm, Poster Board: 0.8mm – 1.5mm]
Print Speed	CAD A1: Plain Paper 300dpi x 600dpi : 21 sec 600dpi x 600dpi Line Draw: 27 sec Poster A1 : Plain Paper 300dpi x 600dpi EPSON Vivid : 21 sec
Media Thickness	Up to 1.5mm
Interface	USB 3.0, Ethernet (100BASE-TX/1000BASE-T), Wi-Fi (IEEE802.11b/g/n), Wi-Fi Direct (Simple AP, up to 8 device connections), USB Host Direct Print (PDF, TIFF, JPEG, HP-GL/2, HP RTL)
Memory	4GB, Optional 960GB SSD
Power Consumption	Operating : 75 W, Ready : 32 W, Sleep : 2 W, Standby : 0.3 W
Dimensions (W x D x H)	1365x499x975 mm
Weight	118 kg
Adobe Postscript 3	N/A

SURECOLOR SC-T3730DE



Max Print Width	24 inch wide (borderless)
Print Head	2.64 MicroTFP
Max Resolution	2401 dpi x 1200 dpi
Min Droplet Size	3.5 pl
Ink System	Ultrachrome XD3 pigment ink
Type	All Pigment Aqueous
Colours	C+M+Y+R+MK+PK (Black Matte/Photo Black)
Cartridge Size	110/350/700 ml
Paper Size	Two automatic roll switch (top-and front loading), [Roll: 0.07mm – 0.8mm, Cut Sheet: 0.07mm – 0.8mm, Poster Board: 0.8mm – 1.5mm]
Print Speed	CAD A1: Plain Paper 300dpi x 600dpi : 21 sec 600dpi x 600dpi Line Draw: 27 sec Poster A1 : Plain Paper 300dpi x 600dpi EPSON Vivid : 21 sec
Media Thickness	Up to 1.5mm
Interface	USB 3.0, Ethernet (100BASE-TX/1000BASE-T), Wi-Fi (IEEE802.11b/g/n), Wi-Fi Direct (Simple AP, up to 8 device connections), USB Host Direct Print (PDF, TIFF, JPEG, HP-GL/2, HP RTL)
Memory	4GB, Optional 960GB SSD
Power Consumption	Operating : 75 W, Ready : 32 W, Sleep : 2 W, Standby : 0.3 W
Dimensions (W x D x H)	1365x499x975 mm
Weight	118 kg
Adobe Postscript 3	N/A

BUSINESS INKJET PRINTER

SURECOLOR SC-T3730D



Max Print Width	24 inch wide (borderless)
Print Head	2.64 MicroTFP
Max Resolution	2401 dpi x 1200 dpi
Min Droplet Size	3.5 pl
Ink System	Ultrachrome XD3 pigment ink
Type	All Pigment Aqueous
Colours	C+M+Y+R+MK+PK (Black Matte/Photo Black)
Cartridge Size	110/350/700 ml
Paper Size	Two automatic roll switch (top-and front loading), [Roll: 0.07mm - 0.8mm, Cut Sheet: 0.07mm - 0.8mm, Poster Board: 0.8mm - 1.5mm]
Print Speed	CAD A1: Plain Paper 300dpi x 600dpi : 21 sec 600dpi x 600dpi Line Draw: 27 sec Poster A1 : Plain Paper 300dpi x 600dpi EPSON Vivid : 21 sec Up to 1.5mm
Media Thickness Interface	USB 3.0, Ethernet (100BASE-TX/1000BASE-T), Wi-Fi (IEEE802.11b/g/n), Wi-Fi Direct (Simple AP, up to 8 device connections), USB Host Direct Print (PDF, TIFF, JPEG, HP-GL/2, HP RTL)
Memory	4GB, Optional 960GB SSD
Power Consumption	Operating : 75 W, Ready : 32 W, Sleep : 2 W, Standby : 0.3 W
Dimensions (W x D x H)	1365x499x975 mm
Weight	118 kg
Adobe Postscript 3	Available

SURECOLOR SC-T5730D



Max Print Width	36 inch wide (borderless)
Print Head	2.64 MicroTFP
Max Resolution	2401 dpi x 1200 dpi
Min Droplet Size	3.5 pl
Ink System	Ultrachrome XD3 pigment ink
Type	All Pigment Aqueous
Colours	C+M+Y+R+MK+PK (Black Matte/Photo Black)
Cartridge Size	110/350/700 ml
Paper Size	Two automatic roll switch (top-and front loading), [Roll: 0.07mm - 0.8mm, Cut Sheet: 0.07mm - 0.8mm, Poster Board: 0.8mm - 1.5mm]
Print Speed	CAD A1: Plain Paper 300dpi x 600dpi : 23 sec AO Size: 300dpi x 600dpi Line Draw : 28 sec Poster: Plain Paper 300dpi x 600dpi EPSON Vivid : 32 sec
Media Thickness Interface	Up to 1.5mm USB 3.0, Ethernet (100BASE-TX/1000BASE-T), Wi-Fi (IEEE802.11b/g/n), Wi-Fi Direct (Simple AP, up to 8 device connections), USB Host Direct Print (PDF, TIFF, JPEG, HP-GL/2, HP RTL)
Memory	4GB, Optional 960GB SSD
Power Consumption	Operating : 80 W, Ready : 32 W, Sleep : 2 W, Standby : 0.3 W
Dimensions (W x D x H)	1645x499x975 mm
Weight	136.8 kg
Adobe Postscript 3	Available

BUSINESS INKJET PRINTER

T-Series Surecolor Technical Series

SURECOLOR SC-T5730DM



Max Print Width	36 inch wide (borderless)
Print Head	2.64 MicroTFP
Max Resolution	2401 dpi x 1200 dpi
Min Droplet Size	3.5 pl
Ink System	Ultrachrome XD3 pigment ink
Type	All Pigment Aqueous
Colours	C+M+Y+R+MK+PK (Black Matte/Photo Black)
Cartridge Size	110/350/700 ml
Paper Size	Two automatic roll switch (top-and front loading), [Roll: 0.07mm – 0.8mm, Cut Sheet: 0.07mm – 0.8mm, Poster Board: 0.8mm – 1.5mm]
Print Speed	CAD A1: Plain Paper 300dpi x 600dpi : 23 sec AO Size:300dpi x 600dpi Line Draw : 28 sec Poster: Plain Paper 300dpi x 600dpi EPSON Vivid : 32 sec
Media Thickness	Up to 1.5mm
Interface	USB 3.0, Ethernet [100BASE-TX/1000BASE-T], Wi-Fi (IEEE802.11b/g/n), Wi-Fi Direct (Simple AP, up to 8 device connections), USB Host Direct Print [PDF, TIFF, JPEG, HP-GL/2, HP RTL]
Memory	4GB, Optional 960GB SSD
Power Consumption	Operating : 80 W, Ready : 32 W, Sleep : 2 W, Standby : 0.3 W
Dimensions (W x D x H)	1645x499x975 mm
Weight	136.8 kg
Adobe Postscript 3	Available

SURECOLOR SC-T7730D



Max Print Width	44 inch wide (borderless)
Print Head	2.64 MicroTFP
Max Resolution	2400 dpi x 1200 dpi
Min Droplet Size	3.5 pl
Ink System	Ultrachrome XD3 pigment ink
Type	All Pigment Aqueous
Colours	C+M+Y+R+MK+PK (Black Matte/Photo Black)
Cartridge Size	110/350/700 ml
Paper Size	Two automatic roll switch (top-and front loading), [Roll: 0.07mm – 0.8mm, Cut Sheet: 0.07mm – 0.8mm, Poster Board: 0.8mm – 1.5mm]
Print Speed	CAD A1: Plain Paper 300dpi x 600dpi : 23 sec AO Size:300dpi x 600dpi Line Draw : 28 sec Poster: Plain Paper 300dpi x 600dpi EPSON Vivid : 32 sec BO Size: Plain Paper 300dpi x 600dpi EPSON Vivid : 46 sec
Media Thickness	Up to 1.5mm
Interface	USB 3.0, Ethernet [100BASE-TX/1000BASE-T], Wi-Fi (IEEE802.11b/g/n), Wi-Fi Direct (Simple AP, up to 8 device connections), USB Host Direct Print [PDF, TIFF, JPEG, HP-GL/2, HP RTL]
Memory	4GB, Optional 960GB SSD
Power Consumption	Operating : 70 W, Ready : 32 W, Sleep : 2 W, Standby : 0.3 W
Dimensions (W x D x H)	1848x499x975 mm
Weight	155 kg
Adobe Postscript 3	Available

BUSINESS INKJET PRINTER

SURECOLOR SC-T7730DM



Max Print Width	44 inch wide (borderless)
Print Head	2.64 MicroTFP
Max Resolution	2400 dpi x 1200 dpi
Min Droplet Size	3.5 pl
Ink System	Ultrachrome XD3 pigment ink
Type	All Pigment Aqueous
Colours	C+M+Y+R+MK+PK (Black Matte/Photo Black)
Cartridge Size	110/350/700 ml
Paper Size	Two automatic roll switch (top-and front loading), [Roll: 0.07mm – 0.8mm, Cut Sheet: 0.07mm – 0.8mm, Poster Board: 0.8mm – 1.5mm]
Print Speed	CAD A1: Plain Paper 300dpi x 600dpi : 23 sec AO Size: 300dpi x 600dpi Line Draw : 28 sec Poster: Plain Paper 300dpi x 600dpi EPSON Vivid : 32 sec BO Size: Plain Paper 300dpi x 600dpi EPSON Vivid : 46 sec*
Media Thickness	Up to 1.5mm
Interface	USB 3.0, Ethernet (100BASE-TX/1000BASE-T), Wi-Fi (IEEE802.11b/g/n), Wi-Fi Direct (Simple AP, up to 8 device connections), USB Host Direct Print (PDF, TIFF, JPEG, HP-GL/2, HP RTL)*
Memory	4GB, Optional 960GB SSD
Power Consumption	Operating : 70 W, Ready : 32 W, Sleep : 2 W, Standby : 0.3 W
Dimensions (W x D x H)	1848x499x975 mm
Weight	155 kg
Adobe Postscript 3	Available

SURECOLOR SC-T7730DL



Max Print Width	44 inch wide (borderless)
Print Head	2.64 MicroTFP
Max Resolution	2400 dpi x 1200 dpi
Min Droplet Size	3.5 pl
Ink System	Ultrachrome XD3 pigment ink
Type	All Pigment Aqueous
Colours	C+M+Y+R+MK+PK (Black Matte/Photo Black)
Cartridge Size	1000 ml
Paper Size	Two automatic roll switch (top-and front loading), [Roll: 0.07mm – 0.8mm, Cut Sheet: 0.07mm – 0.8mm, Poster Board: 0.8mm – 1.5mm]
Print Speed	CAD A1: Plain Paper 300dpi x 600dpi : 23 sec AO Size: 300dpi x 600dpi Line Draw : 28 sec Poster: Plain Paper 300dpi x 600dpi EPSON Vivid : 32 sec BO Size: Plain Paper 300dpi x 600dpi EPSON Vivid : 46 sec*
Media Thickness	Up to 1.5mm
Interface	USB 3.0, Ethernet (100BASE-TX/1000BASE-T), Wi-Fi (IEEE802.11b/g/n), Wi-Fi Direct (Simple AP, up to 8 device connections), USB Host Direct Print (PDF, TIFF, JPEG, HP-GL/2, HP RTL)*
Memory	4GB, Optional 960GB SSD
Power Consumption	Operating : 70 W, Ready : 32 W, Sleep : 2 W, Standby : 0.3 W
Dimensions (W x D x H)	1848x499x975 mm
Weight	155 kg
Adobe Postscript 3	Available

BUSINESS INKJET PRINTER

T-Series Surecolor Technical Series

SURECOLOR SC-T3130

Versatile
Media Handling

Printhead

Up to
1.5mm
ThickUp to 24"
Wide

Max Print Width	24 inch wide (610 mm)
Print Head	PrecisionCore TFP with VSDT and Auto Head Alignment
Max Resolution	2400 dpi x 1200 dpi
Min Droplet Size	4.0 pl
Ink System	Epson Ultrachrome XD2 Pigment Ink
Type	All-Pigment Aqueous
Colours	C+M+Y+K
Cartridge Size	CMY 26/50 ml, K 50/80 ml
Print Speed (A1 sheet)	CAD A1: 34 sec
Paper Size	Single roll top loaded spindle, 2" core, 0.05-0.21 mm thick, 329-610 mm wide, 110 mm max diameter, 3kg max weight
Interface	USB 3.0 & Ethernet 10Base-T/100Base-TX/1000Base-T, Wi-Fi, Wi-Fi Direct, Air Print
OS Compatibility	Windows 10 / 8.1 / 8 / 7 / Vista / XP, Mac OSx10.6.8 or later
Memory	1 GB
Power Consumption	28W Operating, 8W Standby, 1.6W Sleep
Dimensions (W x D x H)	970 x 505 x 230
Weight	38 kg

SURECOLOR SC-T3130N

Versatile
Media Handling

Printhead

Up to
1.5mm
ThickUp to 24"
Wide

Max Print Width	24 inch wide (610 mm)
Print Head	Precision Core TFP with VSDT and Auto Head Alignment
Max Resolution	2400 dpi x 1200 dpi
Min Droplet Size	4.0pl
Ink System	Epson Ultrachrome XD2 Pigment Ink
Type	All-Pigment Aqueous
Colours	C+M+Y+K
Cartridge Size	CMY 26/50 ml, K50/80 ml
Print Speed (A1 sheet)	CAD A1:34 sec
Paper Size	Single roll top loaded spindle, 2" core, 0.05-0.21 mm thick, 329-610mm wide, 110 mm max diameter, 3 kg max weight
Interface	USB 3.0 & Ethernet 10Base-T/100Base-TX/1000Base-T, Wi-Fi, Wi-Fi Direct, Air Print
OS Compatibility	Windows 10 / 8.1 / 8 / 7 / Vista / XP, Mac OSx10.6.8 or later
Memory	1 GB
Power Consumption	28W Operating, 8W Standby, 1.6 W Sleep
Dimensions (W x D x H)	970 x 505 x 230 cm
Weight	27 kg

BUSINESS INKJET PRINTER

SURECOLOR SC-T3130X



Max Print Width Print Head	24 inch wide (610 mm) Precision Core TFP with VSDT and Auto Head Alignment
Max Resolution	2400 dpi x 1200 dpi
Min Droplet Size	3.8pl
Ink System	Epson Ultrachrome XD2 Pigment Ink
Type	All-Pigment Aqueous
Colours	C+M+Y+K
Cartridge Size	140 ml
Print Speed (A1 sheet)	CAD A1:34 sec
Paper Size	Single roll top loaded spindle, 2" core, 0.05-0.21 mm thick, 329-610mm wide, 110 mm max diameter, 3 kg max weight
Interface	USB 3.0 & Ethernet 10Base-T/100Base-TX/1000Base-T, Wi-Fi, Wi-Fi Direct, Air Print
OS Compatibility	Windows 10/ 8.1 / 8 / 7 / Vista / XP, Mac OSx10.6.8 or later
Memory	1 GB
Power Consumption	28W Operating, 8W Standby, 1.6 W Sleep
Dimensions (W x D x H)	970 x 577 x 245 cm
Weight	29 kg

SURECOLOR SC-T3130M



Max Print Width Print Head	24 inch wide (610 mm) Precision Core TFP with VSDT and Auto Head Alignment
Max Resolution	2400 dpi x 1200 dpi
Min Droplet Size	4.0pl
Ink System	Epson Ultrachrome XD2 Pigment Ink
Type	All-Pigment Aqueous
Colours	C+M+Y+K
Cartridge Size	CMY 26/50 ml, K 50/80 ml
Scan Technology	Contact Image Sensor (CIS) with RGB filters
Light Source	Dual Low Angle / RGB LED
Feed System	Sheet pass-through
Max Resolution	600 dpi
Max Scan Speed	11.43 cm/s or 4.5 ips (Colour) 19.05 cm/s or 7.5 ips (Mono)
Max Copy Speed	38 sec per A1 sheet mono 44 sec per A1 sheet colour
Print Speed (A1 sheet)	CAD A1:34 sec
Paper Size	Single roll top loaded spindle, 2" core, 0.05-0.21 mm thick, 329-610mm wide, 110 mm max diameter, 3 kg max weight
Interface	USB 3.0 & Ethernet 10Base-T/100Base-TX/1000Base-T, Wi-Fi, Wi-Fi Direct, Air Print
OS Compatibility	Windows 10/ 8.1 / 8 / 7 / Vista / XP, Mac OSx10.6.8 or later
Memory	1 GB+8GB*For scanner data processing
Power Consumption	24W Operating, 11W Standby, 2.0 W Sleep
Dimensions (W x D x H)	970 x 292 x 230
Weight	44.4 kg

BUSINESS INKJET PRINTER

T-Series Surecolor Technical Series

SURECOLOR SC-T3270



Versatile Media Handling



Printhead



Up to 1.5mm Thick



Up to 24" Wide*



Max Print Width	24 inch wide (borderless)
Print Head	PrecisionCore TFP with VSDT and Auto Head Alignment
Max Resolution	2880 dpi x 1440 dpi
Min Droplet Size	3.5pl
Ink System	Epson Ultrachrome® XD
Type	All-Pigment Aqueous
Colours	C+Y+M+Mk / Pk (Black Matte / Photo Black)
Cartridge Size	110 / 350 / 700 ml
Print Speed	Production POS: 28 sec (360 x 720 dpi) Quality POS: 66 sec (720 x 720 dpi) Production CAD: 30 sec (360 x 720 dpi) Quality CAD: 60 sec (720x1440 dpi)
Paper Size	Spindle-less front loading single roll, 2" or 3" core, 0.08-0.5 mm thick, 254-610 mm wide, 150 mm max diameter with Media Barcode System & auto tension control
Interface	USB 2.0 & Ethernet
OS Compatibility	10Base-T / 100Base-TX / 1000Base-T Windows XP / Vista / 7 / 8 (32 / 64bit), Mac OSx10.5 or later, Win server 2003 & 2008 Standard / Standard 64bit
Memory	1 GB, Optional 320 GB HDD
Power Requirement	52W Operating, 16W Ready, 3W Sleep
Dimensions (W x D x H)	1120 x 248 x 760 mm
Weight	approx. 54 kg

SURECOLOR SC-T3430



Versatile Media Handling



Printhead



Up to 1.5mm Thick



Up to 24" Wide*



Max Print Width	24 inch wide (610 mm)
Print Head	PrecisionCore TFP with VSDT and Auto Head Alignment
Max Resolution	2,400 dpi x 1,200 dpi
Min Droplet Size	4.0pl
Ink System	Epson Ultrachrome® XD2
Type	All-Pigment Aqueous
Colours	C+M+Y+K
Cartridge Size	CMYK 110/350 ml
Print Speed (A1 Sheet)	CAD A1: 25 sec
Paper Size	Single roll top loaded spindle, 2" core, 3" core for plain paper, 0.08 to 0.3 mm thick, 254-610 mm wide, 170 mm max diameter, max weight 12kg
Interface	USB 3.0 & Ethernet 10Base-T / 100Base-TX / 1000Base-T, Wi-Fi, Wi-Fi Direct, Air Print
OS Compatibility	Windows 10 / 8.1 / 8 / 7 / Vista / XP, Mac OS x 10.6.8 or later
Memory	1 GB
Power Consumption	34W Operating, 13W Standby, 1.3W Sleep
Dimensions (W x D x H)	1,080 x 668 x 585 mm
Weight	64kg

BUSINESS INKJET PRINTER

SURECOLOR SC-T3435



Max Print Width	24 inch wide (610 mm)
Print Head	Precision Core TFP with VSDT and Auto Head Alignment
Max Resolution	2400 dpi x 1200 dpi
Min Droplet Size	4.0pl
Ink System	Epson Ultrachrome XD2 Pigment Ink
Type	All-Pigment Aqueous
Colours	C+M+Y+K
Cartridge Size	CMYK, 100 ml/350 ml/700 ml
Scan Integration	Available connect with Business Inkjet Printer Scanner : WF-C17590, WF-C20590, WF-C20600, WF-C20750, WF-C21000, WF-M20590, WF-R8591, WF-C869R, WF-C878R, WF-C879R,
Print Speed (A1 sheet)	CAD A1:25 sec
Paper Size	Single roll top loaded spindle, 2/3" core, 0.08-0.3 mm thick, 254-610mm wide, 170 mm max diameter, 8 kg max weight
Interface	USB 3.0 & Ethernet 10Base-T/100Base-TX/1000Base-T, Wi-Fi, Wi-Fi Direct, Air Print
OS Compatibility	Windows 10/ 8.1 / 8 / 7 / Vista / XP, Mac OSx10.6.8 or later
Memory	1 GB
Power Consumption	34W Operating, 13W Standby, 1.3 Sleep
Dimensions (W x D x H)	1080 x 1060 x 750 cm (with stand)
Weight	64 kg

SURECOLOR SC-T5130



Max Print Width	36 inch wide (914 mm)
Print Head	PrecisionCore TFP with VSDT and Auto Head Alignment
Max Resolution	2,400 dpi x 1,200 dpi
Min Droplet Size	4.0pl
Ink System	Epson Ultrachrome® XD2
Type	All-Pigment Aqueous
Colours	C+M+Y+K
Cartridge Size	CMY 26/50 ml, K 50/80 ml
Print Speed (A3 Sheet)	CAD A3: 31 sec
Paper Size	Single roll top loaded spindle, 2" core, 0.05-0.21 mm thick, 329-910 mm wide, 110 mm max diameter, 5kg max weight
Interface	USB 3.0 & Ethernet 10Base-T / 100Base-TX / 1000Base-T, Wi-Fi, Wi-Fi Direct, Air Print
OS Compatibility	Windows 10 / 8.1 / 8 / 7 / Vista / XP, Mac OS x 10.6.8 or later
Memory	1 GB
Power Consumption	28W Operating, 8W Standby, 1.6W Sleep
Dimensions (W x D x H)	1,268 x 913 x 696 mm
Weight	46 kg

EPSON

BE
cool



**PRODUCE BIG,
ACCURATE PRINTS
WITH A SMALLER IMPACT.**

BUSINESS INKJET PRINTER

SURECOLOR SC-T5130M



Max Print Width	36 inch wide (914 mm)
Print Head	Precision Core TFP with VSDT and Auto Head Alignment
Max Resolution	2400 dpi x 1200 dpi
Min Droplet Size	4.0pl
Ink System	Epson Ultrachrome XD2 Pigment Ink
Type	All-Pigment Aqueous
Colours	C+M+Y+K
Cartridge Size	CMY 26/50 ml, K 50/80 ml
Scan Technology	Contact Image Sensor (CIS) with RGB filters
Light Source	Dual Low Angle / RGB LED
Feed System	Sheet pass-through
Max Resolution	600 dpi
Max Scan Speed	11.43 cm/s or 4.5 ips (Colour) 19.05 cm/s or 7.5 ips (Mono)
Max Copy Speed	38 sec per A1 sheet mono 44 sec per A1 sheet colour
Print Speed (A1 sheet)	CAD A1:31 sec
Paper Size	Single roll top loaded spindle, 2" core, 0.05-0.21 mm thick, 297-914mm wide, 110 mm max diameter, 3 kg max weight
Interface	USB 3.0 & Ethernet 10Base-T/100Base-TX/1000Base-T, Wi-Fi, Wi-Fi Direct, Air Print
OS Compatibility	Windows 10/ 8.1 / 8 / 7 / Vista / XP, Mac OSx10.6.8 or later
Memory	1 GB+8GB* For scanner data processing
Power Consumption	26W Operating, 12W Standby, 2.0 Sleep
Dimensions (W x D x H)	1268 x 975 x 696 cm (with stand)
Weight	54.8 kg

SURECOLOR SC-T5270/T5270D



SC-T5270 Single Roll
SC-T5270D Dual Roll



Max Print Width	36 inch wide (914 mm)
Print Head	PrecisionCore TFP with VSDT and Auto Head Alignment
Max Resolution	2,880 dpi x 1,440 dpi
Min Droplet Size	3.5pl
Ink System	Epson Ultrachrome® XD
Type	All-Pigment Aqueous
Colours	C+Y+M+Mk/Pk (Black Matte/Photo Black)
Cartridge Size	110/350/700 ml
Paper Size	Spindle-less front-loading single roll, 2" or 3" core, 0.08-0.5 mm thick, 254-914 mm wide, 150 mm max diameter with Media Barcode System & auto tension control
Print Speed	Production Post: 28 sec (360 dpi x 720 dpi a1 sheet) 50 sec (360 x 720 dpi, A0 sheet) Quality Post: 66 sec (720 x 720 dpi, A1 sheet) Production CAD: 30 sec (360 x 720 dpi, A1 sheet) 54 sec (360 x 720 dpi, A0 sheet) Quality CAD: 60 sec (720x1440 dpi, A1 sheet)
Media Thickness	SC-T5270 Single top-loading rollfeed, Manual top-loading sheet fed, Manual front-loading thick board feed Rolls (0.08mm-0.5mm thickness; max roll diameter 150mm) = 254 - 914mm width Sheets (0.08mm - 0.8mm thickness) = 210 - 914mm Thickness board = 0.8 - 1.5mm SC-T5270D Two automatic roll feeds (top-and front loading), Manual top-loading sheet fed, Manual front-loading thick board feed Rolls (0.08mm-0.5mm thickness; max roll diameter 150mm) = 254 - 914 mm width, Sheets (0.08mm - 0.8mm thickness) = 210 - 914 mm, Thickness board = 0.8 - 1.5mm
Scan Performance (MFP Configurations Only)	Max Scan Speed 3.3 inch/sec greyscale / 8.4 inch/sec colour. Scan/Copy up to 600 dpi
Interface	USB 2.0 & Ethernet 10Base-T / 100Base-TX / 1000Base-T
OS Compatibility	Windows XP / Vista / 7 / 8 (32/64bit), Mac OS x 10.5 or later, Win server 2003 & 2008 Standard/ Standard 64bit
Memory	1 GB, Optional 320 GB HDD
Power Requirement	61W Operating, 17W Ready, 3W Sleep
Dimensions (W x D x H)	1405 x 1128 x 1070 mm (SC-T5270), 1539 x 1321 x 1074 mm (SC-T5270D)
Weight	84 kg (SC-T5270), 118 kg (SC-T5270D)

BUSINESS INKJET PRINTER

T-Series Surecolor Technical Series

SURECOLOR SC-T5430

Versatile
Media Handling

Printhead

Up to
1.5mm
ThickUp to 36"
Wide

Max Print Width	36 inch wide (914 mm)
Print Head	PrecisionCore TFP with VSDT and Auto Head Alignment
Max Resolution	2400 dpi x 1200 dpi
Min Droplet Size	4.0 pl
Ink System	Epson Ultrachrome® XD2
Type	All-Pigment Aqueous
Colours	C+M+Y+K
Cartridge Size	CMYK 110/350ml
Print Speed (A1 Sheet)	CAD A1: 22 sec
Paper Size	Single roll top loaded spindle, 2" core, 3" core for plain paper, 0.08 to 0.3 mm thick, 254-914 mm wide, 170 mm max diameter, max weight 12kg
Interface	USB 3.0 & Ethernet 10Base-T / 100Base-TX / 1000Base-T, Wi-Fi, Wi-Fi Direct, Air Print
OS Compatibility	Windows 10 / 8.1 / 8 / 7 / Vista / XP, Mac OS x 10.6.8 or later
Memory	1 GB
Power Consumption	38W Operating, 13W Standby, 1.3W Sleep
Dimensions (W x D x H)	1,385 x 750 x 1,060 mm
Weight	76 kg

SURECOLOR SC-T5435

Versatile
Media Handling

Printhead

Up to
1.5mm
ThickUp to 36"
Wide

Max Print Width	36 inch wide (914 mm)
Print Head	Precision Core TFP with VSDT and Auto Head Alignment
Max Resolution	2400 dpi x 1200 dpi
Min Droplet Size	4.0pl
Ink System	Epson Ultrachrome XD2 Pigment Ink
Type	All-Pigment Aqueous
Colours	C+M+Y+K
Cartridge Size	CMYK, 100 ml/350 ml/700 ml
Scan Integration	Available connect with Business Inkjet Printer Scanner :
	WF-C17590, WF-C20590, WF-C20600, WF-C20750, WF-C21000, WF-M20590
	WF-R8591, WF-C869R, WF-C878R, WF-C879R,
Print Speed (A1 sheet)	CAD A1:22 sec
Paper Size	Single roll top loaded spindle, 2/3" core, 0.08-0.3 mm thick, 254-914mm wide, 170 mm max diameter, 12 kg max weight
Interface	USB 3.0 & Ethernet 10Base-T/100Base-TX/1000Base-T, Wi-Fi, Wi-Fi Direct, Air Print
OS Compatibility	Windows 10/ 8.1 / 8 / 7 / Vista / XP, Mac OSx10.6.8 or later
Memory	1 GB
Power Consumption	38W Operating, 13W Standby, 1.3 Sleep
Dimensions (W x D x H)	1385 x 1070 x 750 cm (with stand)
Weight	76 kg

BUSINESS INKJET PRINTER

SURECOLOR SC-T5430M



Max Print Width	36 inch wide (914 mm)
Print Head	PrecisionCore TFP with VSDT and Auto Head Alignment
Max Resolution	2400 dpi x 1200 dpi
Min Droplet Size	4.0 pl
Ink System	Epson Ultrachrome® XD2
Type	All-Pigment Aqueous
Colours	C+M+Y+K
Cartridge Size	CMYK 110/350ml
Scan Technology	Contact Image Sensor (CIS) with RGB filters
Light Source	Dual Low Angle
Feed System	Sheet pass-through
Max Resolution	600 dpi
Max Scan Speed	11.43 cm/s or 4.5 ips (Colour) 19.05 cm/s or 7.5 ips (Mono)
Max Copy Speed	38 sec per A1 sheet mono 44 sec per A1 sheet colour
Print Speed (A1 Sheet)	CAD A1 : 22 sec
Paper Size	Single roll top loaded spindle, 2" core, 3" core for plain paper, 0.08 to 0.3 mm thick, 254-914 mm wide, 170 mm max diameter, max weight 12kg
Interface	USB 3.0 & Ethernet 10Base-T / 100Base-TX / 1000Base-T, Wi-Fi, Wi-Fi Direct, Air Print
OS Compatibility	Windows 10 / 8.1 / 8 / 7 / Vista / XP, Mac OS x 10.6.8 or later
Memory	1 GB
Power Consumption	Operating 38W, Standby 13W, Sleep 1.6W
Dimensions (W x D x H)	1,385 x 966 x 1,060 mm
Weight	89 kg

SURECOLOR SC-T7270/T7270D



SC-T7270 Single Roll
SC-T7270D Dual Roll



Max Print Width	44 inch wide (borderless)
Print Head	PrecisionCore TFP with VSDT and Auto Head Alignment
Max Resolution	2,880 dpi x 1,440 dpi
Min Droplet Size	3.5 pl
Ink System	Epson Ultrachrome® XD
Type	All-Pigment Aqueous
Colours	C+Y+M+Mk (Matte Black/Photo Black)
Cartridge Size	110 / 350 / 700 ml
Print Speed	Production Post: 28 sec (360 dpi x 720 dpi, A1 sheet)
Media Thickness	SC-T7270 Single top-leading rollfeed, Manual top-loading sheet fed Manual front-loading thick board feed, Rolls (0.08mm-0.5mm thickness; max roll diameter 150mm) = 254 - 1118mm width, Sheets (0.08mm - 0.8mm thickness) = 210 - 1118 mm, Thickness board = 0.8 - 1.5mm SC-T7270D Two automatic roll feeds (top-and front loading), Manual top-loading sheet fed, Manual front-loading thick board feed Rolls (0.08mm-0.5mm thickness; max roll diameter 150mm) = 254 - 1118 mm width, Sheets (0.08mm - 0.8mm thickness) = 210 - 1118 mm, Thickness board = 0.8 - 1.5mm
Scan Performance (MFP Configurations Only)	Max Scan Speed: 146 mm/s @ 200 dpi colour/greyscale 77 mm/s @ 300 dpi colour/greyscale 57 mm/s @ 360 dpi colour/greyscale 15 mm/s @ 600 dpi colour/greyscale
Interface	USB 2.0 & Ethernet 10Base-T/100Base-TX / 1000Base-T
Memory	1 GB, Optional 320 GB HDD
Power Consumption	65W Operating, 17W Ready, 3W Sleep
Dimensions (W x D x H)	1608 x 1128 x 1070 mm [SC-T7270] 1742 x 1321 x 1074 mm [SC-T7270D]
Weight	92kg [SC-T7270], 133 kg [SC-T7270D]

BUSINESS INKJET PRINTER

Business Inkjet Printer Consumable

MATERIAL DESCRIPTION

WF-C5390 & WF-C5890

C13T11F100	STANDARD CAPACITY BLACK INK PACK
C13T11F200	STANDARD CAPACITY CYAN INK PACK
C13T11F300	STANDARD CAPACITY MAGENTA INK PACK
C13T11F400	STANDARD CAPACITY YELLOW INK PACK
C13T11H100	HIGH CAPACITY BLACK INK PACK



WF-C579R

C13T01C100	WF-C579R BK / Standard
C13T01C200	WF-C579R C / Standard
C13T01C300	WF-C579R M / Standard
C13T01C400	WF-C579R Y / Standard
C13T01D100	WF-C579R BK / Large
C13T01D200	WF-C579R C / Large
C13T01D300	WF-C579R M / Large
C13T01D400	WF-C579R Y / Large



L6550/L6580/L15160/L15180/M15180

C13T06G199	008 CAHILL/CAVANI, BLACK 127ML (EIN)
C13T06G299	008 CAHILL/CAVANI, CYAN 70ML (EIN)
C13T06G399	008 CAHILL/CAVANI, MAGENTA 70ML (EIN)
C13T06G499	008 CAHILL/CAVANI, YELLOW 70ML (EIN)



WF-C878R & WF-C879R

C13T05A100	WF-C878R/C879R INK PACK, BLACK/STD
C13T05A200	WF-C878R/C879R INK PACK, CYAN/STD
C13T05A300	WF-C878R/C879R INK PACK, MAGENTA/STD
C13T05A400	WF-C878R/C879R INK PACK, YELLOW/STD
C13T05B100	WF-C878R/C879R INK PACK, BLACK/LARGE
C13T05B200	WF-C878R/C879R INK PACK, CYAN/LARGE
C13T05B300	WF-C878R/C879R INK PACK, MAGENTA/LARGE
C13T05B400	WF-C878R/C879R INK PACK, YELLOW/LARGE



AM-C4000

C13T08F100	INK CARTRIDGE, BLACK
C13T08F200	INK CARTRIDGE, CYAN
C13T08F300	INK CARTRIDGE, MAGENTA
C13T08F400	INK CARTRIDGE, YELLOW



AM-C5000/6000

C14T08E100	INK CARTRIDGE, BLACK
C14T08E200	INK CARTRIDGE, CYAN
C14T08E300	INK CARTRIDGE, MAGENTA
C14T08E400	INK CARTRIDGE, YELLOW



WF-C20750

C13T02S100	INK CARTRIDGE, BK, 75PPM
C13T02S200	INK CARTRIDGE, C, 75PPM
C13T02S300	INK CARTRIDGE, M, 75PPM
C13T02S400	INK CARTRIDGE, Y, 75PPM

WF-C21000

C13T02Y100	INK CARTRIDGE, BK, 100PPM
C13T02Y200	INK CARTRIDGE, C, 100PPM
C13T02Y300	INK CARTRIDGE, M, 100PPM
C13T02Y400	INK CARTRIDGE, Y, 100PPM



WF-M21000

C13T04Q100	BLACK INK, MONO LIJ
------------	---------------------

BUSINESS INKJET PRINTER

Business Inkjet Printer Consumable

MATERIAL CODE	DESCRIPTION
---------------	-------------



T5430/T3430
C13T41D200 CYAN 350ML
C13T41D300 MAGENTA 350ML
C13T41D400 YELLOW 350ML
C13T41D500 BLACK 350ML
C13T41Q200 CYAN 110ML
C13T41Q300 MAGENTA 110ML
C13T41Q400 YELLOW 110ML
C13T41Q500 BLACK 110ML



C-T3130/SC-T3130N/SC-T5130/ SC-T3130M/SC-T5130M
C13T40A100 BLACK INK CARTRIDGE 50ML
C13T40A200 CYAN INK CARTRIDGE 26ML
C13T40A300 MAGENTA INK CARTRIDGE 26ML
C13T40A400 YELLOW INK CARTRIDGE 26ML
C13T40B100 BLACK INK CARTRIDGE 80ML
C13T40B200 CYAN INK CARTRIDGE 50ML
C13T40B300 MAGENTA INK CARTRIDGE 50ML
C13T40B400 YELLOW INK CARTRIDGE 50ML



T3130X
C13T49K100 BLACK 140ML
C13T49K200 CYAN 140ML
C13T49K300 MAGENTA 140ML
C13T49K400 YELLOW 140ML



T3270/T5270/T7270
C13T692100 PHOTOBLACK 110ML
C13T692200 CYAN 110ML
C13T692300 MAGENTA 110ML
C13T692400 YELLOW 110ML
C13T692500 MATTE BLACK 110ML
C13T693100 PHOTOBLACK 350ML
C13T693200 CYAN 350ML
C13T693300 MAGENTA 350ML
C13T693400 YELLOW 350ML
C13T693500 MATTE BLACK 350ML
C13T694100 PHOTOBLACK 700ML
C13T694200 CYAN 700ML
C13T694300 MAGENTA 700ML
C13T694400 YELLOW 700ML
C13T694500 MATTE BLACK 700ML



SC-T3435/SC-T5435
C13T41Q500 BLACK INK CARTRIDGE 110ML
C13T41Q200 CYAN INK CARTRIDGE 110ML
C13T41Q300 MAGENTA INK CARTRIDGE 110ML
C13T41Q400 YELLOW INK CARTRIDGE 110ML
C13T41D500 BLACK INK CARTRIDGE 350ML
C13T41D200 CYAN INK CARTRIDGE 350ML
C13T41D300 MAGENTA INK CARTRIDGE 350ML
C13T41D400 YELLOW INK CARTRIDGE 350ML
C13T41C500 BLACK INK CARTRIDGE 700ML
C13T41C200 CYAN INK CARTRIDGE 700ML
C13T41C300 MAGENTA INK CARTRIDGE 700ML
C13T41C400 YELLOW INK CARTRIDGE 700ML



SC-T3730/5730/7730/D
C13T51F200 CYAN IC (110 ML)
C13T51F800 MATTE BLACK IC (110ML)
C13T51F300 MAGENTA IC (110ML)
C13T51F100 PHOTOBLACK IC (110ML)
C13T51FF00 RED IC (110ML)
C13T51F400 YELLOW IC (110ML)
C13T50Y200 CYAN IC (350ML)
C13T50Y800 MATTEBLACK IC (350ML)
C13T50Y300 MAGENTA IC (350ML)
C13T50Y100 INK PHOTOBLACK IC (350ML)
C13T50YF00 RED IC (350ML)
C13T50Y400 YELLOW IC (350ML)
C13T50R200 CYAN IC (700ML)
C13T50R800 MATTEBLACK IC (700ML)
C13T50R300 MAGENTA IC (700ML)
C13T50R100 PHOTOBLACK IC (700ML)
C13T50RF00 RED IC (700ML)
C13T50R400 YELLOW IC (700ML)

COMMERCIAL & INDUSTRIAL PRINTER

1
TEXTILE
PRINTER BRAND
YEAR 2022

US Worldwide Quarterly Industrial Printer Tracker, 2022



1
SIGNAGE
PRINTER BRAND
YEAR 2022

US Worldwide Quarterly Industrial Printer Tracker, 2022



1
GRAPHIC
PRINTER BRAND
YEAR 2022

US Worldwide Quarterly Industrial Printer Tracker, 2022



COMMERCIAL & INDUSTRIAL PRINTER

MENGAPA MEMILIH EPSON PRINTER ?

Epson large format printer memastikan hasil warna yang luar biasa sehingga menjadi pilihan yang tepat untuk mendukung berbagai bisnis Anda mulai dari Advertising, fashion, retail dan photography.

Print head Epson Micro Piezo™

Print head Epson Micro Piezo™ Thin Film Piezo yang khusus dikembangkan untuk printer Large Format Epson, memiliki performa dan daya tahan tinggi dengan 360 micro-fine nozzles untuk setiap warnanya, memberikan bentuk dot (titik) yang sempurna. Teknologi ini menggunakan Variable-Sized Droplet Technology (VSDT) untuk memproduksi butiran tinta dalam berbagai ukuran sampai sekecil 3.5 pico-litres (pl) yang mampu menghemat waktu mencetak dan mengoptimalkan kualitas. Print head juga dilengkapi dengan Ink-Repelling Coating, lapisan pada permukaan print head untuk mengurangi kemungkinan terjadinya penyumbatan pada tinta. Teknologi printhead yang berupa lapisan tipis unik piezo (TFP) yang memadukan teknologi komponen superior dengan teknologi fabrikasi Micro-Electro-Mechanical-System (MEMS) yang berpresisi tinggi. Hasilnya adalah kecepatan cetak dan mutu gambar yang tinggi untuk pemakaian di berbagai kegiatan usaha dan industri.



Print Head Epson Micro Piezo

Teknologi Variasi Butiran Tinta (VSDT)

Epson LUT (Look Up Table) Technology

Dengan teknologi Epson LUT, hasil cetak printer format besar Epson menampilkan gradasi halus, butiran tampak berkurang dan warna tidak dapat berubah, menjadikan hasil cetak indah dan gambar berdefinisi tinggi.



COMMERCIAL & INDUSTRIAL PRINTER

P SurePress Label Printers

SUREPRESS SP-L6534VW



Print Technology	PrecisionCore linehead inkjet technology
Max Print Resolution	600 x 1200 dpi
Substrate Width	80mm to 340mm
Substrate Type	Adhesive Paper, Adhesive Film, Single Layer Paper, Single Layer Film
Substrate Thickness	80 to 320 microns
Substrate Treatment	Corona Treatment, Static Ionizer, UV Curing Lamp
Unwinder Capacity	600mm dia / 100kg weight / 1,000m length
Ink Type	UV Curable Inks
Ink Cartridges	Black, Cyan, Magenta, Yellow, Digital Varnish, White, Storage liquid
Print Speed	Productivity Mode: 50m/min, Standard Mode: 30m/min, High Density Mode: 15m/min, Reverse White Mode: 7.6m/min
Dimensions	4250 (W) x 2290 (D) x 2520 (H) mm
Weight	2640 kg

Available with Orange Ink

SUREPRESS SP-L4733AW



Model No	SurePress L 4733AW
Printing Technology	Epson MicroPiezo inkjet technology
Ink Type	SurePress AQ Ink T4 (SurePress AQ)
Ink cartridge	Black, Uncoated Black, Cyan, Magenta, Yellow, Orange, Green, Over print liquid, Moisture liquid (AW model only: White, Storage liquid)
Image size	315.2mm x 914.4mm
Print speed	Up to 8.2 meter per minute *
Substrate thickness	80 to 320 µm
Substrate width	80 to 334mm Adjustable to support any width in this range
Substrate support	Standard self adhesive label substrate, Semi gloss, gloss and matte paper stock, BOPP, PET, Yupo and pre laminated film
Unwinder capacity (Max.)	100kg weight / 1,000m length, 600mm diameter with 76mm (3") inner core
Dimensions of Press (WxDxH)	3950 x 1,910mm x 2,020mm
Dimensions of Press and Rewinder (WxDxH)	5100 x 1,910mm x 2,020mm
Weight of Press	Approximately 1870kg(TBD) including rewriter
Weight of Rewinder	Approximately 180kg
Network connectivity	Ethernet 1000 base T or higher is recommended
Power requirements	Input voltage range: Rated voltage 10% (180 220V) Rated voltage: AC (3 phases 3 lines) 200V
Temperature (Operating)	18 - 28 derajat celcius
Relative Humidity (Operating)	35 - 55% (no condensation)
Max. sound level (Operating)	75dB or less (excluding the alarm sound)

EPSON

GO
BIG



ON THE
DETAILS.

COMMERCIAL & INDUSTRIAL PRINTER

B Series | Surecolor Bulk Series

SURECOLOR SC-B6070



Versatile
Media Handling



Up to 44"
Black



Up to 44"
Wide



Ethernet



**Max Print Width
Print Head**

1118 mm (44")
MicroPiezo TFP® Print Head with Variable-Sized
Droplet Technology

**Max Resolution
Min Droplet Size
Ink System
Colours**

720 dpi x 1440 dpi
3.8pl
Dye Ink
Cyan, Magenta, Yellow, Black

Print Speed

Tank: 1500 ml Pack: 1000 ml
High Speed / Resolution: 360 x 720 dpi /
Passes: 2 = 30.6 m²/h
Production 1 / Resolution: 720 x 720 dpi /
Passes: 3 = 22.6 m²/h
Production 2 / Resolution: 720 x 1440 dpi / Passes:
4 = 15.8 m²/h
High Quality / Resolution: 720 x 1440 dpi / Passes:
7/8 = 6.2 m²/h

Paper Size

Maximum Paper Width: 1118 mm (44")
Minimum Cut-sheet Size: 254 mm (10.0")
Hi-Speed USB 2.0, Ethernet 100BASE-TX /
1000 BASE-T

Interface

OS Compatibility

Windows Vista / 7 / 8 / 8.1 / 10 (64bit) or later, Mac
OS 10.6 or later

Memory

512 MB Network: 128 MB

Power Consumption

Operating: Approx. 65W
Standby: Approx. 20W
Sleep: Approx. 3W (Interface is 1000BASE-T)
Power Off: Less Than 0.4W

SURECOLOR SC-B7070



Versatile
Media Handling



Up to 44"
Up to 1 mm



Up to 44"
Wide



Ethernet



**Max Print Width
Print Head**

1625.6 mm (64")
MicroPiezo TFP® Print Head with Variable-Sized
Droplet Technology

**Max Resolution
Min Droplet Size
Ink System
Colours**

720 dpi x 1440 dpi
5.2pl
Dye Ink
Cyan, Magenta, Yellow, Black

Print Speed

Tank: 1500 ml Pack: 1000 ml
High Speed / Resolution: 360 x 720 dpi /
Passes: 2 = 30.6 m²/h
Production 1 / Resolution: 720 x 720 dpi /
Passes: 3 = 22.6 m²/h
Production 2 / Resolution: 720 x 1440 dpi / Passes:
4 = 15.8 m²/h
High Quality / Resolution: 720 x 1440 dpi / Passes:
7/8 = 6.2 m²/h

Paper Size

Maximum Paper Width: 1118 mm (44")
Minimum Cut-sheet Size: 254 mm (10.0")
Hi-Speed USB 2.0, Ethernet 100BASE-TX /
1000 BASE-T

Interface

OS Compatibility

Windows Vista / 7 / 8 / 8.1 / 10 (64bit) or later, Mac
OS 10.6 or later

Memory

512 MB Network: 128 MB

Power Consumption

Operating: Approx. 65W
Standby: Approx. 20W
Sleep: Approx. 3W (Interface is 1000BASE-T)
Power Off: Less Than 0.4W

COMMERCIAL & INDUSTRIAL PRINTER

SURECOLOR SC-B9070



Max Print Width
Print Head

max. 1,616 mm
Dual PrecisionCore™ TFP® Printhead
2880 dpi x 1440 dpi

Max Resolution
Min Droplet Size
Ink System
Colours

4.1 pl
New Formula Dye Ink
Epson Dye Ink
Cyan, Magenta, Yellow, Black

Print Speed

Pouch: 1,000 ml; CISS Tank: 1,500 ml
Draft - 1 Pass: Up to 100 m²/h (360 x 720 dpi)
Speed - 4 Pass: Up to 31 m²/h (720 x 720 dpi)
Production - 6 Pass: Up to 20.5 m²/h (720 x 1440 dpi)
Quality - 8 Pass: Up to 15.3 m²/h (720 x 1440 dpi)
High Quality - 12 Pass: Up to 8.6 m²/h (2880 x 1440 dpi)
Max Quality - 16 Pass: Up to 6.7 m²/h (2880 x 1440 dpi)
Max Quality - 24 Pass: Up to 4.8 m²/h (2880 x 1440 dpi) [Backlit Film]
Media Width: 300 to 1,626 mm (64 inch)
Media Thickness: Up to 1 mm

Paper Size

Interface

Hi-Speed USB 2.0, Ethernet 100BASE-TX / 1000BASE-T

OS Compatibility
Memory
Power Consumption

Windows Vista / 7 / 8 / 8.1 / 10 (64bit) or later
512 MB Main + 128 MB Network
Operating: Approx. 440 W (=75 W + 360 W)
Ready: Approx. 320 W (=34 W + 280 W)
Sleep: Approx. 14 W (=13 W + 0.5 W)
Power off: Approx. 1.1 W (=0.6 W + 0.5 W)



F-Series

Surecolor Fabric Series

SURECOLOR SC-F2230



Max Print Width
Print Head
Max Resolution
Min Droplet Size
Ink System
Colours
Cartridge Size
Print Speed

Standard & Medium Grooved Platen: 356 x 406 mm
PrecisionCore MicroTFP Printhead
1200 dpi x 1200 dpi

12.8 pl
UltraChrome DG2 Ink
Cyan, Magenta, Yellow, Black, White
800ml

Cotton Garment Material

Drying: 170°C, 45 seconds [For dark T-shirt] /
Fixing: 170°C, 45 seconds [For dark T-shirt / light T-shirt]

Polyester Garment Material (For dark T-shirt)

Drying: 130°C, 60 seconds / Fixing: 130°C, 90 seconds

Polyester Garment Material (For light T-shirt)

Drying: 130°C, 60 seconds / Fixing: 130°C, 30 seconds

Hi-Speed USB 2.0 x 2 [For PC x1, for USB flash

memory x 1], 1000 Base-T
Windows & Mac Compatible

Interface

OS Compatibility
Memory
Power Consumption

1GB
Operating: Approx. 46W, Ready: Approx. 30W, Sleep:
Approx. 7.0W, Standby: Approx. 0.3W

Dimension
Weight

981 W x 499 H x 1,361 mm D
94.5 kg

NEW
PRODUCT



COMMERCIAL & INDUSTRIAL PRINTER

F Surecolor Fabric Series

**SURECOLOR
SC-F3030**
Dual
Print HeadBulk Ink
SolutionUp to 29.5 mm
thicknessSelf Repair
FunctionDirect To
Garment

Max Print Width	406 x 508 mm (using optional Large Platen)
Print Head	PrecisionCore Micro TFP print head x 2
Max Resolution	1,200 x 1,200 dp
Min Droplet Size	12.1 pl
Ink System	Epson Ultrachrome® DG
Colours	CYMKWW
Cartridge Size	1500ml
Print Speed	Fast 14s (Colour Only), 26s (White + Colour) Production: 21s (Colour Only), 40s (White + Colour) Quality: 36s (Colour Only), 47s (White + Colour) High Quality: 48s (Colour only), 70s (White + Colour)
Interface	Rear High Speed USB 2.0 & Ethernet 100Base/T1000 Base- T/100 Base Front panel USB for file storage &Uploading (FAT32 format)
OS Compatibility	Windows & Mac Compatible.
Memory	4GB
Power Consumption	168 W Operating, 111W Ready, 20W Sleep

**SURECOLOR
SC-F130**
Genuine
WarrantyWi-Fi
ConnectCompact
DesignOutstanding
Print Quality

Paper Width	A4, LTR, Legal
Printhead	PrecisionCore Micro TFP Printhead
Max. Resolution	600 x 1,200 dpi
Ink Type	Dye Sublimation Transfer Ink
Colours	Cyan, Magenta, Yellow, Black
Paper Path	Friction Feed
Print Speed	65 seconds (Default)
Interfaces	Hi-Speed USB *2, Ethernet (10BASE-T / 100BASE-TX), Wi-Fi (IEEE 802.11 b/g/n)
Memory	132 Kbyte (Input Buffer Memory)
Voltage	AC 220 - 240V (withstand voltage AC 400V)
W x D x H	375x503x187mm
Frequency	50/60 Hz
Power Consumption	Operating: Approx. 13W Ready: Approx. 4.1W Sleep: Approx. 0.7W
Weight	Approx. 4.6 kg (without ink bottle)
Warranty	1 Year/6000 sheets, Whichever comes first

COMMERCIAL & INDUSTRIAL PRINTER

SURECOLOR SC-F530



Printer Width	24"
Print Head	PrecisionCore TFP Printhead
Maximum Resolution	2400 x 1200 dpi
Ink System	Epson Genuine Dye-Sublimation Ink
Colours	Cyan, Magenta, Yellow, Black
Print Speed	Production (2 pass), For Fabric: Up to 62 sec / 21 m ² (600 x 1200 dpi), Production (7 pass): For Fabric & Rigid: Up to 208 sec / 7.5 m ² (1200 x 1200 dpi), Production (12 pass), For Fabric & Rigid: Up to 350 sec / 4.5 m ² (2400 x 1200 dpi)
Interface	USB 2.0 Hi-speed, Ethernet 100BASE-TX / 1000BASE-T
OS Compatibility	Windows 10 / 8.1 / 8 / 7 / Vista / XP, Mac OSx10.6.8 or later
Memory	1 GB
Power Consumption	Operating: Approx. 22W, Ready: Approx. 8W Sleep: Approx. 1.6W, Power Off (Stand by): Approx. 0.2W
Dimension	Storage (W x H x D): 970 mm x 245 mm x 577 mm Printing (W x H x D): 970 mm x 245 mm x 811 mm
Weight	29kg

SURECOLOR SC-F531



Max. Print Width	24 inch
Print Head	PrecisionCore TFP [®] Printhead
Max. Resolution	2,400 x 1,200 dpi
Min. Droplet Size	4.0pl
Ink Type	Epson Genuine Dye-SUblimat ion Ink
Colours	4 Colours - Cyan, Flourescent Pink, Flourescent Yellow Black
Cartridge Size	Cyan, Magenta, Yellow: 26ml, 50ml ; Black: 50ml , 80ml
Print Speed	Production (2 pass), For Fabric: Up to 62 sec / 21 m ² (600 x 1200 dpi) ; Production (7 pass): For Fabric & Rigid: Up to 208 sec / 7.5 m ² (1200 x 1200 dpi) Production (12 pass), For Fabric & Rigid: Up to 350 sec / 4.5 m ² (2400 x 1200 dpi)
Interface	Super-Speed USB 100BASE-TX/1000BASE-T/IEEE802.11 b/g/n
Memory	1 GB
Power Consumption	Ready: Approx. 8W; Sleep: Approx. 1.6 W Operating: Approx. 28W; Power Off: Approx 0.2W
Dimensions	970 x 505 x 230 (WxDxH)
Weight	29 kg (without ink cartridges)

COMMERCIAL & INDUSTRIAL PRINTER

F Surecolor Fabric Series

**SURECOLOR
SC-F7270**
Versatile
Media Handlingup to 64"
Media ThicknessUp to 64"
Media Width

Ethernet



Max Print Width	64 inches (1625.6mm)
Print Head	10 channel PrecisionCore™ TFP with VSDT
Max Resolution	720 dpi x 1440 dpi
Ink System	Epson Ultrachrome® DS
Type	Dye Sublimation
Colours	C+Y+M+Bk / C+Y+M+HDK
Cartridge Size	4 x 1.5L
Print Speed	Normal Mode Draft: 58.9 m ² /hr 1 Pass 360 x 720dpi Normal Mode Fast Production: 30.3m ² /hr; 2 Pass 720 x 720 dpi; Normal Mode Production 1: 22.2m ² /hr 3 Pass 720 x 720dpi; HQ Mode Production 1: 13.8m ² /hr 4 Pass 720 x 720dpi
Paper Size	Thickness 0.08-1mm (75 gsm or greater) Width 300-1625.6 mm
Interface	High Speed USB 2.0 & Ethernet 100Base-T/ 1000Base-T
OS Compatibility	Windows 10 / 8.1 / 8 / 7 (32/64bit) or later (64bit required for Edge Print); Mac OS X 10.7 Lion or later
Memory	512 MB Main + 128MB Network
Power Consumption	460W Operating (heater on), 10W Sleep (heater off, 1000Base-T Interface)
Dimensions (W x D x H)	2620 x 1013 x 1314 mm (W x D x H)
Weight	274kg

**SURECOLOR
SC-F6430/H**

44" wide

Maintenance
AreaTake Up
Reel

Ethernet

Ink Tank
1,5L

Max Print Width	44 inch
Print Head	PrecisionCore MicroTFP Printhead
Max Resolution	600 x 1,200 dpi
Ink System	SC-F6430 UltraChrome DS Ink (Cyan, Magenta, Yellow, High Density Black)
Type	SC-F6430H UltraChrome DS 6 Ink (Cyan, Magenta, Yellow, High Density Black, Light Cyan, Light Magenta, Fluorescent Yellow, Fluorescent Pink, Orange, Violet)
Ink Capacity	Dye Sublimation
Refill	4 x 1.5L Continuous Ink Supply System (CISS)
Paper Size	1.6 L Thickness Up to 0.5 mm Width 254 mm to 1,118 mm (10" to 44")
Interface	Super Speed USB, 100BASE-TX/1000BASE-T
Memory	1 GB
Power Consumption	80W Operating, 36W Ready, 19W Sleep
Weight	SC-F6430 With Take Up Reel: Approx. 133 kg Without Take Up Reel: Approx. 120 kg
	SC-F6430H With Take Up Reel: Approx. 140 kg Without Take Up Reel: Approx. 127 kg

COMMERCIAL & INDUSTRIAL PRINTER

SURECOLOR SC-F9430



Max Print Width	64 inch (1625.6 mm)
Print Head	DUAL Epson PrecisionCore™ TFP
Max Resolution	720 dpi x 1440 dpi
Min Droplet Size	4 pl
Ink System	Epson Ultrachrome® DS
Type	Epson Sublimation
Colours	Dual CYMHD
Cartridge Size	8 / 10 x 1.5L Continuous Ink Supply System (CISS)
Refill	1.1L CYMHDk
Print Speed	4c Fast Fabric Production: 360 x 720 dpi (2 Pass) 60.1 m2/hr 4c Standard Fabric Production : 720 x 720 dpi (3 Pass) 44.1 m2/hr 4c HQ Standard Rigid Production : 720 x 720 dpi (6 Pass) 20.7 m2/hr 6c Standard Fabric Production (F9430H only): 720 x 1440 dpi (6 Pass) 21.9m2/hr 6c HQ Standard Rigid Production (F9430H only): 720 x 1440 dpi (12 Pass) 10.6m2/hr
Paper Size	300 - 1626 mm wide x 250 mm diameter, 2"/3" core
Interface	High Speed USB 2.0 Ethernet 100Base-T / 1000Base-T
OS Compatibility	Windows 10, 8/8.1, 7 SP1 64bit or later
Memory	512 MB Main + 128 MB Network
Power Consumption	570W Operating / Standby 340W / 14W Sleep (1000BASE-T)

SURECOLOR SC-F9430H



Max Print Width	64 inch (1625.6 mm)
Print Head	DUAL Epson PrecisionCore™ TFP
Max Resolution	720 dpi x 1440 dpi
Min Droplet Size	4 pl
Ink System	Epson Ultrachrome® DS6
Type	Epson Sublimation
Colours	Dual CYMHDk + Single Fp & Fy (F9430H)
Cartridge Size	8 / 10 x 1.5L Continuous Ink Supply System (CISS)
Refill	1.1L CYMHDk
Print Speed	4c Fast Fabric Production: 360 x 720 dpi (2 Pass) 60.1 m2/hr 4c Standard Fabric Production : 720 x 720 dpi (3 Pass) 44.1 m2/hr 4c HQ Standard Rigid Production : 720 x 720 dpi (6 Pass) 20.7 m2/hr 6c Standard Fabric Production (F9430H only): 720 x 1440 dpi (6 Pass) 21.9m2/hr 6c HQ Standard Rigid Production (F9430H only): 720 x 1440 dpi (12 Pass) 10.6m2/hr
Paper Size	300 - 1626 mm wide x 250 mm diameter, 2"/3" core
Interface	High Speed USB 2.0 Ethernet 100Base-T / 1000Base-T
OS Compatibility	Windows 10, 8/8.1, 7 SP1 64bit or later
Memory	512 MB Main + 128 MB Network
Power Consumption	570W Operating / Standby 340W / 14W Sleep (1000BASE-T)

COMMERCIAL & INDUSTRIAL PRINTER

F Surecolor Fabric Series

**SURECOLOR
SC-F10030**

Max Media Width	76 inch (1950mm)
Print Head	FOUR 4.7" Epson PrecisionCore™ TFP
Nozzle Configuration	800 x 4 per head/colour
Maximum Resolution	1200 x 1200dpi
Min Droplet Size	Dye Sublimation Epson Ultrachrome® DS
Colours	CYM + HDk
Supply	DUAL Continuous Ink Supply System (CISS) with auto hot-swap
Refills	Choice of 3L or 10L box type PERFORMANCE
Max Quality	1200 x 1200dpi*4 (9 Pass) 29.3m ² /hr
Size	300-1950mm wide, 250mm max diameter/ 60Kg max weight
Thickness	0.04-1mm
Control Panel	9" Colour Touch LCD
Interface	High Speed USB 3.0, Ethernet 1000Base-T
Memory	155GBI
Power Supply	2 x 16A, 240V, 50/60 Hz AC
Power Consumption	3.9kW Operating / 221W Sleep / 9.6W Off
Dimensions (W x D x H) Printer	1303mm x 2886mm x 4607mm, 683Kg (without media holders or ink)
Operational Space (W x D x H)	CISS: 877 x 556 x 541mm, 53kg (no ink)
Weight	5.6 x 3.3 x 2.0m recommended 736kg (without ink)

**SURECOLOR
SC-F10030H**

Max Media Width	76 inch (1950mm)
Print Head	six 4.7" Epson Precision Core tm TFP
Colours	CMY + HDk + Fluorescent Pink Fluorescent Yellow or Light Magenta Light Cyan
Dimensions (W x D x H)	196" x 52" x 75" (4,978 mm x 1,303 mm x 1,886 mm)
Weight	Approx. 767 kg (Without ink cartridges)
Printing Dimensions (W x H x D)	5,008 x 1,886 x 1,303 mm
Power Consumption	Operating: Approx. 4.4kw Ready: Approx. 230W Sleep: Approx. 230W Power Off [Stand by]: Approx. 9.6 W



COMMERCIAL & INDUSTRIAL PRINTER

Direct-To-Fabric Printer

ML-8000

Print Technology	PrecisionCore Inkjet Technology
Number of Print Head	8
Max Resolution	1,200 x 1,200 dpi [Pigment], 1,200 x 600 dpi [Reactive, Acid, Disperse]
Print Speed	Print Speed Square : 290 (300 x 600 dpi, 1 pass)1 / 3,122 (300 x 600 dpi, 1 pass)† Print Speed Linear : 193 (300 x 600 dpi, 1 pass)1 / 634 (300 x 600 dpi, 1 pass)†
Power Consumption	12kVA
Network	USB 3.0 Ethernet 1000BASE-T
Dimensions	Printer: 3,700 (W) x 2,690 (D) x 1,830 (H) mm [146 x 106 x 72 in], Ink rack (with 10L ink) : 880 (W) x 960 (D) x 790 (H) mm [35 x 38 x 31 in] Printer : Approx. 2,150 kg [4,740 lb], Ink rack : Approx. 110 kg [243 lb, not including ink]
Weight	290 sqm/h (300x600) dpi, 1 pass Typical printing speed 155 sqm/h (600x600) dpi, 2 pass
Print Speed	



Monna Lisa Evo Tre 16

Print Technology	PrecisionCore Inkjet Technology
Number of Print Head	16
Max Resolution	1,200 x 1,200 dpi
Print Speed	Draft 1 404 m ² /h Draft 2 270 m ² /h Production 1 221 m ² /h Production 2 171 m ² /h Production 3 135 m ² /h High Quality 1 103 m ² /h High Quality 2 79 m ² /h High Quality 3 63 m ² /h
Humidity	35-80% RH [Condensation]
Dimension	Printing Machine: Approx. 4,660 (W) x 2,390 (D) x 1,940 (H) mm Control Box: 620 (W) x 1,220 (D) x 2,070 (H) mm Ink Rack: 1,240 (W) x 1,300 (D) x 1,220 (H) mm
Electrical	Printing Machine: AC 3 Phase 400V 50A (50/60 Hz)
Weight	4,650 kg
Print Speed	Maximum Printing Speed 434 sqm/h (300x600) dpi, 1 pass Typical Printing Speed 239 sqm/h (600x600) dpi, 2 pass 161 sqm/h (900x600) dpi, 3 pass



COMMERCIAL & INDUSTRIAL PRINTER

Direct-To-Fabric Printer

Monna Lisa ML32000



Print Technology
Number of Print Head
Max Resolution
Print Speed

PrecisionCore Inkjet Technology

32

1,200 x 1,200 dpi

Maximum Printing Speed (m2/h)

697 (300 x 600 dpi, 1 Pass)

Typical Printing Speed 1 (m2/h)

423 (600 x 600 dpi, 2 Pass)

Typical Printing Speed 2 (m2/h)

305 (900 x 600 dpi, 3 Pass)

Maximum Printing Speed (sq ft/hr)

7,502 (300 x 600 dpi, 1 Pass)

Typical Printing Speed 1 (sq ft/hr)

4,553 (600 x 600 dpi, 2 Pass)

Typical Printing Speed 2 (sq ft/hr)

3,283 (900 x 600 dpi, 3 Pass)

Humidity
Dimension

40 - 60% RH (no condensation)

Printing Machine: Approx. 4,610 (W) x 2,500 (D) x

2,070 (H) mm

Control Box: 660 (W) x 1,500 (D) x 2,290 (H) mm

Working Area: 8,110 (W) x 5,400 (D) x 2,290 (H) mm

Electrical
Weight

400V, 3 phase + Neutral + Earth

n/a

Monna Lisa ML64000



Print Technology
Number of Print Head
Max Resolution
Print Speed

PrecisionCore Inkjet Technology

64

1,200 x 1,200 dpi

Typical Printing Speed 1 (m2/h)

740 (600 x 600 dpi, 2 Pass)

Typical Printing Speed 2 (m2/h)

533 (900 x 600 dpi, 3 Pass)

Typical Printing Speed 1 (sq ft/hr)

7,965 (600 x 600 dpi, 2 Pass)

Typical Printing Speed 2 (sq ft/hr)

5,737 (900 x 600 dpi, 3 Pass)

Humidity
Dimension

40 - 60% (no condensation)

Printing Machine: Approx. 6,510 (W) x 4,960 (D) x

2,530 (H) mm

Working Area: 8,500 (W) x 7,270 (D) x 2,640 (H) mm

Electrical
Weight

AC 220 - 240V (withstand voltage AC 400V)

n/a

COMMERCIAL & INDUSTRIAL PRINTER

P-Series

Surecolor Photographic Series

SURECOLOR SC-P8530D



Technology	PrecisionCore Inkjet Technology, Variable-Sized Droplet Technology
Max Resolution	2,400 x 1,200 dpi
Min Droplet Size	3.5pl
Ink System	UltraChrome Pro 6 Ink
Ink Capacity	350, 700 ml
Colours	Cyan, Magenta, Yellow, Gray, Photo Black, Matte Black
Interface	SuperSpeed USB, 100BASE-TX / 1000BASE-T/IEEE802.11b/g/n/ac, USB memory stick
Power Consumption	Operating: Approx. 70W, Ready: Approx. 32W, Sleep: Approx. 2.0W, Standby: Approx. 0.3W
Dimension (WxDxH)	1,848 x 975 x 829 mm
Weight	Approx. 155 kg

SURECOLOR SC-P703



Max Print Wide Technology	13 inch wide On-demand ink jet (piezo electric), Variable-Sized Droplet Technology
Max Resolution	5760x1440 dpi
Min Droplet Size	1.5pl
Ink System	UltraChrome PRO10 Ink
Colours	Cyan, Vivid Magenta, Photo Black, Matte Black, Gray, Light Gray, Yellow, Vivid Light Magenta, Light Cyan, Violet
Interface	Wired Connection: Super-Speed USB, 10BASE-T/100BASE-TX, Wireless Connection: Wi-Fi 4
Power Consumption	22 W Operating/ 1.1 W Sleep
Dimension (WxDxH)	Close: 515x368x185 mm, Open: 515x769x420 mm
Weight	Main Unit: Approx. 12.6kg (without ink cartridge)

SURECOLOR SC-P903



Max Print Wide Technology	17 inch wide On-demand ink jet (piezo electric), Variable-Sized Droplet Technology
Max Resolution	5760x1440 dpi
Min Droplet Size	1.5pl
Ink System	UltraChrome PRO10 Ink
Colours	Cyan, Vivid Magenta, Photo Black, Matte Black, Gray, Light Gray, Yellow, Vivid Light Magenta, Light Cyan, Violet
Interface	Wired Connection: Super-Speed USB, 10BASE-T/100BASE-TX, Wireless Connection: Wi-Fi 4
Power Consumption	24 W Operating/ 1.1 W Sleep
Dimension (WxDxH)	Close: 615x368x199 mm, Open: 615x905x520 mm
Weight	Main Unit: Approx. 14.8kg (without ink cartridge), Option roll unit: 3.1kg

COMMERCIAL & INDUSTRIAL PRINTER

P Surecolor Photographic Series

**SURECOLOR
SC-P5000**
Versatile
Media HandlingUp to
1.5mm
ThickUp to 17"
Wide

Ethernet



Max Print Width	17 inch (432 mm)
Print Head	PrecisionCore® TFP
Max Resolution	2880 dpi x 1440 dpi
Min Droplet Size	3.5 pl
Ink System	Epson Ultrachrome® HDX
Type	Aqueous all-pigment
Colours	11 (Configurable with Light Light Black OR Violet)
Cartridge Size	200 ml
Print Speed (A2 sheet)	Draft: 360 dpi x 360 dpi 0.5 minutes Normal: 360 dpi x 720 dpi 0.8 minutes Fine: 720 dpi x 720 dpi 1.8 minutes Super Fine: 720 dpi x 1440 dpi 3.6 minutes Super Photo: 2880 dpi x 1440 dpi 7 minutes
Paper Size	8" x 10" (203 x 254 mm) - A2+ (432 x 610 mm) sheets, 203-432 mm wide x 150 mm diameter 3" core / 103 mm diameter 2" core rolls
Interface	High Speed USB 2.0, Ethernet 10Base-T / 100Base-TX / 1000Base-T
OS Compatibility	Mac OS X 10.6.8 or later, Windows 10, 8/8.1, 7, Vista, & Win XP SP1
Memory	256 MB Main and 128 MB Network
Power Consumption	52W Operating / Standby 20W / 5W Sleep (1000BASE-T)
Dimensions (W x D x H)	863 x 766 x 405 mm (Sheet feed & output tray closed)
Weight	52kg (no ink)

**SURECOLOR
SC-P6000**
Versatile
Media HandlingUp to
1.5mm
ThickUp to 24"
WideBorderless
PrintingPrint Quality
2,880 x 1,440 dpi

Print Head	PrecisionCore™ TFP printhead, Epson Variable-Sized Droplet Technology
Max Resolution	2880x1440 dpi
Min Droplet Size	3.5 pl
Ink System	Epson UltraChrome HD
Colours	Cyan, Photo Black, Matte Black, Vivid Magenta, Yellow, Light Cyan, Vivid Light Magenta, Light Black, Light Light Black
Paper Path	Friction Feed
Roll Dimensions	254mm-610mm, 2inch-core/3inch-core
Paper Size (w) and Thickness	2inch-core: Max 103mm / 3inch-core: Max 150mm 254mm (10") - 610mm (24"): Roll paper 254mm (10") - 610mm (24"): Cut Sheet 0.08-1.50mm
Borderless	254mm (10in.), 300mm (11.8in.), 329mm (13in.), 406mm (16in.), 432mm (17in.), 515mm (20.3in.), 594mm (23in.), 610mm (24in.)
Interface	Hi-Speed USB, 10BASE-T/100BASE-T/1000BASE-T
Dimension (W x D x H)	1,356 x 667 x 1,218 mm
Weight	Approx. 101kg

COMMERCIAL & INDUSTRIAL PRINTER

SURECOLOR SC-P6530E



Versatile Media Handling Up to 1.5mm Thick Up to 24" Wide Borderless Printing



NEW
PRODUCT

Max Print Width 24 Inch
Print Head PrecisionCore Micro TFP printhead
Max Resolution 2400 dpl x 1200 dpl
Min Droplet Size 3.5pl
Ink System Ultra Chrome Pro 6 Ink
Colours 6
Paper Handling Roll Paper / Friction Head
Print Speed 111 Sec, A1 Size Premium Glossy
Printer Interface 1000 BASE-T
OS Compatibility Mac OS X 10.6.8 or later, Mac os 11 or later
Memory 4 GB
Power Consumption Operating approx 75W
Ready approx 32W
Sleep approx 2W
Standby approx 0.3W

SURECOLOR SC-P8000



Versatile Media Handling Up to 1.5mm Thick Up to 44" Wide Borderless Printing Print Quality 2,880 x 1,440 dpi



Print Head PrecisionCore™ TFP printhead,
Epson Variable-Sized Droplet Technology
Max Resolution 2880x1440 dpi
Min Droplet Size 3.5 pl
Ink System Epson UltraChrome HD
Colours Cyan, Photo Black, Matte Black, Vivid Magenta, Yellow, Light Cyan, Vivid Light Magenta, Light Black, Light Light Black
Paper Path Friction Feed
Roll Dimensions 254mm-1118mm, 2inch-core/ 3inch-core
2inch-core: Max 103mm/ 3inch-core: Max 150mm
Paper Size (w) and Thickness 254mm (10") - 1118mm (44"): Roll paper 210mm (A4) - 1118mm (44"): Cut Sheet 0.08-1.50mm
Borderless 728mm (29in.), 841mm (A0/33in.), 914mm (36in.), 1118mm (44in.) 728mm (29in.), 841mm (A0/33in.), 914mm (36in.), 1118mm (44in.)
Interface Hi-Speed USB, 10BASE-T/100BASE-T/1000BASE-T
Dimension (W x D x H) 1,864 x 667 x 1,218 mm
Weight Approx. 135kg

SURECOLOR SC-P7530



Versatile Media Handling Up to 1.5mm Thick Up to 24" Wide Borderless Printing Easy Maintenance



Max Print Width 24 inch
Print Head Micro TFP Printhead
Max Resolution 2400 dpi x 1200 dpi
Min Droplet Size 3.5 pl
Ink System Ultrachrome® Pro12 Pigment Ink
Colours 12
Paper Handling Roll Paper / Friction Feed
Print Speed 97 sec (Level 1) 122 sec (Default) Premium Glossy
Photo Paper 170 gsm A1 size/ISO
Super Speed USB, 100 BASE - TX /
1000 BASE - T
Printer Interface Mac OS X 10.6.8 or later,
OS Compatibility Windows XP / Vista / 7 / 8 / 8.1 (32/64bit) or later
Memory 2 GB
Power Consumption Operating : Approx 85 W
Ready : Approx 32 W
Sleep : Approx 3.4 W
Power Off (Standby) : Approx 0.3 W

COMMERCIAL & INDUSTRIAL PRINTER

P Surecolor Photographic Series

SURECOLOR SC-P9530



Max Print Width	44 inch
Print Head	Micro TFP Printhead
Max Resolution	2400 dpi x 1200 dpi
Min Droplet Size	3.5 pl
Ink System	Ultrachrome® Pro12 Pigment Ink
Colours	12
Paper Handling	Roll Paper / Friction Feed
Print Speed	219 sec (Level 1) 285 sec (Default) Premium Glossy
Printer Interface	Photo Paper 170 gsm B0 size/ISO USB Interface (Hi-Speed USB/USB, 100 BASE - TX / 1000 BASE - T
OS Compatibility	Mac OS X 10.6.8 or later, Windows XP / Vista / 7 / 8 / 8.1 (32/64bit) or later
Memory	2 GB
Power Consumption	Operating : Approx 110 W Ready : Approx 32 W Sleep : Approx 3.4 W Power Off (Stand by) : Approx 0.3 W

S Surecolor Signage Series

SURECOLOR SC-R5030L



Max Print Width	64 inch
Technology	PrecisionCore inkjet technology
Max Resolution	1,200 x 2,400 dpi With 600 x 600 dpi 8 Half Tone layers
Print Speed	Banner Fast Production Vinyl, Paper & Wall Covering - 21m ² /h (600 x 1200dpi 6 pass) Banner Production Vinyl, Paper & Wall Covering - 15.1m ² /h (1200 x 1200dpi 9 pass) Textile Production - 9.5m ² /h (1200 x 1200dpi 14 pass) Film Production - 5.2m ² /h (1200 x 2400dpi 26 pass)
Ink Type/Colours	Resin ink
Ink Capacity	Cyan, Magenta, Yellow, Black, Light Cyan, Light Magenta +Optimizer+Maintenance Liquid @ 3000ml
Interface	USB (Hi-Speed USB), 100BASE-TX/1000BASE-T
Memory	2 GB
Power Consumption	4.6kW Operating/ 220W Ready/ 46W Sleep/ 1.1W Power Off (Stand by)
Dimensions (W x D x H)	Printing : 2,949mm x 1,045mm x 1,774mm Stowed : 2,949mm x 1,045mm x 1,605mm
Weight	449kg

COMMERCIAL & INDUSTRIAL PRINTER



Surecolor Signage Series

SURECOLOR SC-V7000



Epson 1st UV Flatbed Printer

Technology	MicroPiezo Inkjet Technology (Technology 1) Variable-Sized Droplet Technology (Technology 2)
Print Head	MicroPiezo Printhead
Nozzle Configuration	11,520 nozzles (180 nozzles x 8 lines x 8 head)
Max Resolution	720 x 1,440 dpi
Print Speed	Colour High Speed: 360 x 720 dpi, with speed 43.1 m/h
Curing Method	LED-UV type
Ink Type	UV Curable Ink
Colours	Cyan, Magenta, Yellow, Black, Light Cyan, Light Magenta, Gray, Red, White, Varnish
Ink Capacity	1,000 ml (Ink Bottle)
Max Printing Area	Max. 2,500 x 1,250 mm
Max Media Size	Max. 2,500 x 1,250 mm
Interface	Super-Speed USB (Type-B)
Power Consumption	Operating: Approx. 4.8kW
Dimensions (W x D x H)	4,635mm x 2,768mm x 1,730mm
Weight	1,370 kg (With ink cartridges)

SD-10

Digital Colour Spectrophotometer



Technology	Spectroscopic Device
Spectral Range	400 - 700nm
Sampling Interval	Colour Measurement
Photometric Range	10 nm (Interpolation by software)
Light Source	LED (Including UV)
Measurement Conditions	M0: Including UV light component, ISO 13655:2017 measurement condition M0 M1e: D50 - Including UV light component, measurement conditions equivalent to ISO 13655:2017 measurement condition M1 (Measurement conditions held with a radiant power at all wavelengths from 400 to 700 nm, and power ratios in the 300 to 400 nm and 400 to 500 nm regions similar to D50) M2: Without UV, ISO 13655:2017 measurement condition M2
Calibration	White reference built in the sensor cover
Scan Length	400mm
Interfaces	USB Type-C, USB 2.0 Full-Speed BLE Bluetooth Low Energy
Dimensions (W x D x H)	35 x 80 x 80 mm (Shutter Closed) 35 x 80 x 77.6 mm (Shutter Opened)
Weight	Approx. 190g

COMMERCIAL & INDUSTRIAL PRINTER

S Surecolor Signage Series

F

SURECOLOR
SC-S40670Versatile
Media HandlingUp to
1.5mm ThickUp to 64"
Wide

Max Print Width	64 inch
Print Head	PrecisionCore™ TFP® Printhead
Max Resolution	1440 dpi x 1440 dpi
Min Droplet Size	4.2 pl
Ink System	Epson Ultrachrome® GS3
Type	Eco-Solvent Based
Colours	CMYK
Cartridge Size	4 x 700 ml
Print Speed	Draft: 58.4m ² /hr (360 dpi x 720 dpi 1 pass) Billboard: 29.4m ² /hr (720 dpi x 720 dpi 2 pass) Banner: 16.6m ² /hr (720 dpi x 720 dpi 4 pass) Vinyl: 10.5m ² /hr (720 dpi x 1440 dpi 6 pass) Film: 3.5m ² /hr (1440 dpi x 1440 dpi 16 pass)
Paper Size	Single Roll, 2" or 3" core, 250 mm max outer diameter & 45kg max weight Sizing: 300 to 1626 mm wide, 500 mm min length, 1 mm max thickness
Interface	Hi-Speed USB 2.0, 100BASE-TX / 1000BASE-T
RIP Compatibility	Supplied with Epson Edge Print and supports a wide range of 3rd party applications
Memory	512 MB
Power Consumption	480W Operating / 330W Ready/ 12W Sleep
Dimensions (W x D x H)	2,620 x 1,338 x 880 mm (W x H x D)
Weight	279kg

SURECOLOR
SC-S60670Versatile
Media HandlingDual
Print HeadUp to
1.5mm ThickUp to 64"
Wide

Max Print Width	64 inch
Print Head	Dual PrecisionCore™ TFP® Printhead
Max Resolution	1440 dpi x 1440 dpi
Min Droplet Size	4.2 pl
Ink System	Epson Ultrachrome® GS3
Type	Eco-Solvent Based
Colours	CMYK
Cartridge Size	2 x 4 x 700 ml
Print Speed	Max Speed: 95.3m ² /hr (360 dpi x 720 dpi 1 pass) Billboard: 52.3m ² /hr (720 dpi x 720 dpi 2 pass) Banner: 29.4m ² /hr (720 dpi x 720 dpi 4 pass) Vinyl: 17.6m ² /hr (720 dpi x 1440 dpi 6 pass) Film: 6.8m ² /hr (1440 dpi x 1440 dpi 16 pass)
Paper Size	Single Roll, 2" or 3" core, 250 mm max outer diameter & 45kg max weight Sizing: 300 to 1626 mm wide, 500 mm min length, 1 mm max thickness
Interface	Hi-Speed USB 2.0, 100BASE-TX / 1000BASE-T
RIP Compatibility	Supplied with Epson Edge Print and supports a wide range of 3rd party applications
Memory	512 MB Main + 128 MB Network
Power Consumption	745W Operating / 445W Ready/ 13W Sleep
Dimensions (W x D x H)	2,620 x 1,338 x 972 mm (W x H x D)
Weight	291kg

COMMERCIAL & INDUSTRIAL PRINTER

SURECOLOR SC-S60670L



Max Print Width	64 inch
Print Head	Dual PrecisionCore™ TFP® Printhead
Max Resolution	1440 dpi x 1440 dpi
Min Droplet Size	4.2 pl
Ink System	Epson Ultrachrome® GS3
Type	Eco-Solvent Based
Colours	Dual C, M, Y, K (Choice of Standard)
Cartridge Size	2 x 4 x 1500 ml
Print Speed	Max Speed: 95.3m ² /hr (360 dpi x 720 dpi 1 pass) Billboard: 52.3m ² /hr (720 dpi x 720 dpi 2 pass) Banner: 29.4m ² /hr (720 dpi x 720 dpi 4 pass) Vinyl: 17.6m ² /hr (720 dpi x 1440 dpi 6 pass) Film: 6.8m ² /hr (1440 dpi x 1440 dpi 16 pass) Single Roll, 2" or 3" core, 250mm max outer diameter & 45kg max weight Sizing: 300 to 1626mm wide, 500mm min length, 1mm max thickness
Interface	High Speed USB & Ethernet 100Base-T / 1000Base-T
RIP Compatibility	Supplied with Epson Edge Print and supports a wide range of 3rd party applications
Memory	512 MB Main + 128 MB Network
Power Consumption	820W
Dimensions (W x D x H)	2,766 x 1,671 x 1,147mm
Weight	331kg w/ink

SURECOLOR SC-S80670



Max Print Width	64 inches
Print Head	DUAL Print Head PrecisionCore™ TFP® Printhead
Max Resolution	1440 dpi x 1440 dpi
Min Droplet Size	4.2 pl
Ink System	Epson Ultrachrome® GS3 & GS3+RED
Type	Eco-Solvent Based
Colours	C, M, Y, K, Lc, Lm, Lk, Or, Rd + (optional) White or Metallic Silver
Cartridge Size	9 x 700 ml + optional 1 x [600 ml Wht or 350 ml Mtl]
Print Speed	Max Speed(9c): 95.1m ² /hr (360 dpi x 360 dpi 1 pass) Billboard (9c): 31.6m ² /hr (720 dpi x 720 dpi 4 pass HS) Banner (9c): 18.2m ² /hr (720 dpi x 720 dpi 6 pass)
Paper Size	Input Format Single Roll with 2" or 3" core, 250 mm max outer diameter & 45kg max weight Sizing 300 to 1626 mm wide, 500 mm min length, 1 mm max thickness
Interface	High Speed USB 2.0 & Ethernet 100Base-T / 1000Base-T
RIP Compatibility	Supplied with Epson Edge Print and supports a wide range of 3rd party applications
Memory	2 GB, Network: 512MB +128MB
Power Consumption	745W Operating/380W Ready/14W Sleep
Dimensions (W x D x H)	2,620 x 1,338 x 880 mm [W x H x D]
Weight	284kg

COMMERCIAL & INDUSTRIAL PRINTER

S | Surecolor Signage Series

**SURECOLOR
SC-S80670L**
Versatile
Media HandlingDual
Print HeadUp to
1.5mm
ThickUp to A1+
Wide

Max Print Width	64 inches
Print Head	Dual PrecisionCore™ TFP® Printhead
Max Resolution	1440 dpi x 1440 dpi
Min Droplet Size	4.2 pl
Ink System	Epson Ultrachrome® GS3 & GS3+RED
Type	Eco-Solvent Based
Colours	C, M, Y, K, Lc, Lm, Lk, Or, Rd + (optional) White or Metallic Silver
Cartridge Size	9 x 1500 ml + optional 1 x (all color 1500ml) 1500ml White and 500ml Silver Metallic
Print Speed	High Speed: 52.3m/hr (360 dpi x 720 dpi 2 pass)
Paper Handling	Rear Roll Feed / Auto take-up reel
Paper Size	Input Format Single Roll with 2" or 3" core, 250 mm max outer diameter & 45kg max weight Sizing 300 to 1626 mm wide, 500 mm min length, 1 mm max thickness
Interface	High Speed USB & Ethernet 100Base-TX / 1000Base-T
RIP Compatibility	Supplied with Epson Edge Print and supports a wide range of 3rd party applications
Memory	2GB, Network: 128 MB
Power Consumption	640W
Dimensions (W x D x H)	2,766 x 1,671 x 1,090 mm
Weight	326kg w/ink

D | Surelab Photolab Series

**SURELAB
SL-D1030**
Epson
Genuine InkEnvironment
Friendly

Print Head	Micro Piezo Printhead
Max Resolution	1,440 x 720 dpi
Min Droplet Size	2.5 pl
Ink System	Epson UltraChrome D6r-S Dye Ink
Ink Capacity	250ml
Colours	Cyan, Magenta, Yellow, Light Cyan, Light Magenta, Black
Paper Size	Width: 89mm - 210mm ; Length: 148mm - 297mm
Print Size	Roll: Max. 1,000mm, Min. 50mm / Manual Feed: 1,000mm / Auto Sheet Feeder (ASF): 297mm
Interface	Hi-Speed USB, 100BASE-TX/10BASE-T, IEEE802.11b/g/n, Wi-Fi
OS Compatibility	Windows® 10, Windows® 8.1 for each 32bit/64bit, Macintosh Mac OS X (10.9.5 or later), Mac OS 11.X
Power Consumption	Operating: Approx. 80W / Ready: Approx. 14W / Sleep: Approx. 1.2W / Standby: Approx. 0.2W
Dimensions (W x D x H)	Single-sided Model: 460 x 683 x 359 mm Double-sided Model: 460 x 747 x 441 mm
Weight	Single-sided model: 17.6kg Double-sided model: 23.1kg Main unit: 17.6kg, Duplex Feeder: 5.5kg

COMMERCIAL & INDUSTRIAL PRINTER



SURELAB SL-D3000



Print Method	Epson Micro Piezo™ on-demand inkjet with Variable Sized Droplet Technology
Max Resolution	1440 x 1440dpi (Gloss & Lustre) / 720 x 720 dpi (Matte)
Min Droplet Size	1.5pl
Ink System Colours	Epson UltraChrome D6 Ink Colours 6 (Cyan, Yellow, Magenta, Black, Light Cyan, Light Magenta) 700 ml per colour
Media Handling	Single Roll Model Dual Roll Model Rear roll up to 305mm / 12" media width Rear roll up to 305mm / 12" media width Front roll up to 210mm / 8" media width Auto-Switch between front / rear rolls
Printer Interface	USB 2.0 Hi-Speed
OS Compatibility	Microsoft Windows XP Professional (SP3), Windows 7 Professional (32- or 64-bit) 2.8 GHz Intel® Core 2 Duo or better
Memory	-
Power Consumption	500W Operating/ 60W Standby

SURELAB SL-D530



Print Method	Micro Piezo Inkjet Technology with Variable Sized Droplet Technology
Max Resolution	1440 x 720dpi (High Quality) / 720 x 720 dpi (Standard) / 720x360 (Draft)
Max Droplet Size	2.5pl
Ink System Colours	Epson UltraChrome D6r-S Dye Ink Colours 6 (Cyan, Magenta, Yellow, Light Cyan, Light Magenta, Black) 70 ml per colour
Media Handling	Auto Sheet Feeder Width: 89mm - 102mm ; Length: 127mm - 152mm Auto Sheet Feeder: 3.5" x 5", 4" x 6" (100 sheets)
Printer Interface	Hi-Speed USB, 100BASE-TX/10BASE-T, IEEE802.11b/g/n
OS Compatibility	Windows®11, Windows®10, Windows®8.1 for each 32bit/64bit, Macintosh Mac OS X (10/9/5 or later), Mac OS 11.X
Memory	0.5 GB
Power Consumption	18W Operating/ 3.8W Ready/1.4W Sleep/ 0.2W Standby

COMMERCIAL & INDUSTRIAL PRINTER

Commercial & Industrial Printer Consumable

Order Code	Description	Product	Order Code	Description	Product
C13T738100	Black	SC-B6070	C13T824800	Epson UltraChrome HD 350ml Matte Black Pigment Ink Cartridge	SC-P6000
C13T738200	Cyan		C13T824900	Epson UltraChrome HD 350ml Light Light Black Pigment Ink Cartridge	
C13T738300	Magenta		C13T824100	Epson UltraChrome HD 350ml Photo Black Pigment Ink Cartridge	SC-P8000
C13T738400	Yellow		C13T824200	Epson UltraChrome HD 350ml Cyan Pigment Ink Cartridge	
C13T904100	Black	SC-B9070	C13T824300	Epson UltraChrome HD 350ml Vivid Magenta Pigment Ink Cartridge	
C13T904200	Cyan		C13T824400	Epson UltraChrome HD 350ml Yellow Pigment Ink Cartridge	
C13T904300	Magenta		C13T824500	Epson UltraChrome HD 350ml Light Cyan Pigment Ink Cartridge	
C13T904400	Yellow		C13T824600	Epson UltraChrome HD 350ml Vivid Light Magenta Pigment Ink Cartridge	
C13T725100	Epson UltraChrome D6 Ink - Black 600ml	SC-F2130	C13T824700	Epson UltraChrome HD 350ml Light Black Pigment Ink Cartridge	
C13T725200	Epson UltraChrome D6 Ink - Cyan 600ml		C13T824800	Epson UltraChrome HD 350ml Matte Black Pigment Ink Cartridge	
C13T725300	Epson UltraChrome D6 Ink - Magenta 600ml		C13T824900	Epson UltraChrome HD 350ml Light Light Black Pigment Ink Cartridge	
C13T725400	Epson UltraChrome D6 Ink - Yellow 600ml		C13T824100	Epson UltraChrome HD 350ml Photo Black Pigment Ink Cartridge	SC-P7000
C13T725A00	Epson UltraChrome D6 Ink - White 600ml		C13T824200	Epson UltraChrome HD 350ml Cyan Pigment Ink Cartridge	
C13S400080	D5 Transfer General Purpose 24 inch Roll	SC-F530	C13T824300	Epson UltraChrome HD 350ml Vivid Magenta Pigment Ink Cartridge	
C13S400079	D5 Transfer General Purpose 17 inch Roll		C13T824400	Epson UltraChrome HD 350ml Yellow Pigment Ink Cartridge	
C13S400081	D5 Transfer General Purpose A3 Roll		C13T824500	Epson UltraChrome HD 350ml Light Cyan Pigment Ink Cartridge	
C13S400082	D5 Transfer General Purpose A4 Roll		C13T824600	Epson UltraChrome HD 350ml Vivid Light Magenta Pigment Ink Cartridge	
C13S400077	D5 Transfer General Purpose A3 Sheet		C13T824700	Epson UltraChrome HD 350ml Light Black Pigment Ink Cartridge	
C13S400078	D5 Transfer General Purpose A4 Sheet		C13T824800	Epson UltraChrome HD 350ml Matte Black Pigment Ink Cartridge	
C12C933151	Stand (24")		C13T824900	Epson UltraChrome HD 350ml Light Light Black Pigment Ink Cartridge	
C12C935701	Roll Feed Spindle (24")		C13T824100	Epson UltraChrome HD 350ml Photo Black Pigment Ink Cartridge	SC-P7000
C13S210057	Maintenance Box		C13T824200	Epson UltraChrome HD 350ml Cyan Pigment Ink Cartridge	
C13S210055	Auto Cutter Spare Blade		C13T824300	Epson UltraChrome HD 350ml Vivid Magenta Pigment Ink Cartridge	
C13T46H200	Epson UltraChrome D5 Ink - Cyan 1.1L	SC-F6630	C13T824400	Epson UltraChrome HD 350ml Yellow Pigment Ink Cartridge	
C13T46H300	Epson UltraChrome D5 Ink - Magenta 1.1L		C13T824500	Epson UltraChrome HD 350ml Light Cyan Pigment Ink Cartridge	
C13T46H400	Epson UltraChrome D5 Ink - Yellow 1.1L		C13T824600	Epson UltraChrome HD 350ml Vivid Light Magenta Pigment Ink Cartridge	
C13T46H800	Epson UltraChrome D5 Ink - HD Black 1.1L		C13T824700	Epson UltraChrome HD 350ml Light Black Pigment Ink Cartridge	
C13T741200	Epson UltraChrome D5 Ink - Cyan 1L x 6pcs	SC-F7270	C13T824800	Epson UltraChrome HD 350ml Matte Black Pigment Ink Cartridge	
C13T741300	Epson UltraChrome D5 Ink - Magenta 1L x 6pcs		C13T824900	Epson UltraChrome HD 350ml Light Light Black Pigment Ink Cartridge	
C13T741400	Epson UltraChrome D5 Ink - Yellow 1L x 6pcs		C13T824A00	Epson UltraChrome HDX 350ml Orange Pigment Ink Cartridge	
C13T741X00	Epson UltraChrome D5 Ink - HD Black 1L x 6pcs		C13T824B00	Epson UltraChrome HDX 350ml Green Pigment Ink Cartridge	
C13T46H200	Epson UltraChrome D5 Ink - Cyan 1.1L	SC-F9340	C13T824D00	Epson UltraChrome HDX 350ml Violet Pigment Ink Cartridge	
C13T46H300	Epson UltraChrome D5 Ink - Magenta 1.1L		C13T809000	Epson UltraChrome Pro 700ml Light Grey Pigment Ink Cartridge	SC-P20070
C13T46H400	Epson UltraChrome D5 Ink - Yellow 1.1L		C13T809100	Epson UltraChrome Pro 700ml Photo Black Pigment Ink Cartridge	
C13T46H800	Epson UltraChrome D5 Ink - HD Black 1.1L		C13T809200	Epson UltraChrome Pro 700ml Cyan Pigment Ink Cartridge	
C13T46H600	Epson UltraChrome D5 Ink - FY 1.1L		C13T809300	Epson UltraChrome Pro 700ml Vivid Magenta Pigment Ink Cartridge	
C13T46H500	Epson UltraChrome D5 Ink - FP 1.1L		C13T809400	Epson UltraChrome Pro 700ml Yellow Pigment Ink Cartridge	
C13T327100	Photo Black	SC-P407	C13T809500	Epson UltraChrome Pro 700ml Light Cyan Pigment Ink Cartridge	
C13T327200	Cyan		C13T809600	Epson UltraChrome Pro 700ml Vivid Light Magenta Pigment Ink Cartridge	
C13T327300	Magenta		C13T809700	Epson UltraChrome Pro 700ml Dark Grey Pigment Ink Cartridge	
C13T327400	Yellow		C13T809800	Epson UltraChrome Pro 700ml Matte Black Pigment Ink Cartridge	
C13T327700	Red		C13T809900	Epson UltraChrome Pro 700ml Grey Pigment Ink Cartridge	
C13T327800	Matte Black		C13T913100	Epson UltraChrome HD 200ml Photo Black Pigment Ink Cartridge	SC-P5000
C13T327900	Orange		C13T913200	Epson UltraChrome HD 200ml Cyan Pigment Ink Cartridge	
C13T327000	Gloss Optimizer		C13T913300	Epson UltraChrome HD 200ml Vivid Magenta Pigment Ink Cartridge	
C13T763100	Photo Black	SC-P607	C13T913400	Epson UltraChrome HD 200ml Yellow Pigment Ink Cartridge	
C13T763200	Cyan		C13T913500	Epson UltraChrome HD 200ml Light Cyan Pigment Ink Cartridge	
C13T763300	Vivid Magenta				
C13T763400	Yellow				
C13T763500	Light Cyan				
C13T763600	Vivid Light Magenta				
C13T763700	Light Black				
C13T763800	Matte Black				
C13T763900	Light Light Black				
C13T853100	Photo Black	SC-P807			
C13T853200	Cyan				
C13T853300	Vivid Magenta				
C13T853400	Yellow				
C13T853500	Light Cyan				
C13T853600	Vivid Light Magenta				
C13T853700	Light Black				
C13T853800	Matte Black				
C13T853900	Light Light Black				
C13T824100	Epson UltraChrome HD 350ml Photo Black Pigment Ink Cartridge	SC-P6000			
C13T824200	Epson UltraChrome HD 350ml Cyan Pigment Ink Cartridge				
C13T824300	Epson UltraChrome HD 350ml Vivid Magenta Pigment Ink Cartridge				
C13T824400	Epson UltraChrome HD 350ml Yellow Pigment Ink Cartridge				
C13T824500	Epson UltraChrome HD 350ml Light Cyan Pigment Ink Cartridge				
C13T824600	Epson UltraChrome HD 350ml Vivid Light Magenta Pigment Ink Cartridge				
C13T824700	Epson UltraChrome HD 350ml Light Black Pigment Ink Cartridge				

www.epson.co.id/laserprinter

LASER PRINTER



LASER PRINTER

MENGAPA MEMILIH EPSON LASER PRINTER ?

Epson Laser printer di desain untuk memenuhi kebutuhan pertumbuhan bisnis Anda. Mulai dari biaya operasional yang sangat rendah, proses pencetakan yang cepat dan dilengkapi dengan berbagai fitur untuk mendukung volume produktifitas pencetakan yang optimal.

Kualitas Cetak Luar Biasa

Seperti bahan bakar dengan performa tinggi di dalam sebuah mesin, toner asli Epson diformulasikan khusus untuk memberikan output berkualitas tinggi dan dapat diandalkan.

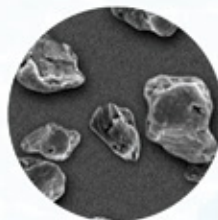

Conventional Toner

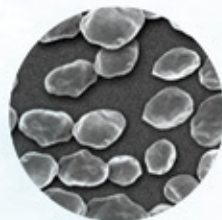

Epson's Genuine Toner

Kualitas Warna Luar Biasa

Dengan ukuran partikel yang sama dan sangat stabil sifat elektrostatis, toner ini menghasilkan bahkan dan cakupan yang stabil sehingga semua cetakan Anda jelas dan dipenuhi dengan warna-warna yang kaya dan hidup

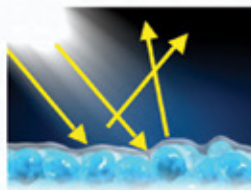

Conventional Toner

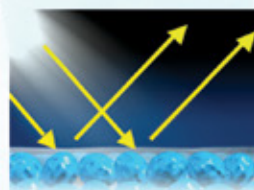

Epson's Genuine Toner

Kejelasan hingga Detail Terbaik

Ukuran partikel Epson yang kecil dan seragam toner asli menghasilkan sangat halus dan hasil akurat untuk mengeluarkan detail sarang sekalipun.



LASER PRINTER

Increase Workgroup's Productivity at Lower Running Cost



ACULASER C9500DN

Printing Technology	A3 Colour Laser Printer
Max Resolution	1,200 x 1,200 dpi
Print Speed	Up to 35 ppm (Simplex) / Up to 25 ppm (Duplex)
Paper Type	Plain Paper / Letterhead / Recycled / Colour / Preprinted / Semi-thick / Thick Paper1 / Thick Paper2 / Labels / Coated / Envelope / Special
Memory Interface	3GB USB 3.0, Network: Ethernet (1000Base-T/100Base-TX/10Base-T)
Connect	Epson iPrint, Epson Email Print, Remote Print Driver
Power Consumption	439W (Black) / 526W (Colour) Operating/ 65W Standby/43W Pre Heat/ 0.71W Sleep
Dimensions & Weight	512 x 518 x 109 mm, 5.1kg

ACULASER M310DN



Max. Resolution	Up to 1,200 x 1,200 dpi
Print Speed	Up to 35 ppm 20,000 pages / month
Monthly Duty Cycle	Standard: Up to 350 sheets Maximum: Up to 850 sheets
Input Paper Capacity	250 sheets
Standard Output Tray Capacity	A4, A5, A6, B5, LT, HLT, LGL, GLT, GLG, EXE, F4, Label, Envelope (C5, C6, DL, Com10, Monarch, ISO-B5), Custom size: from 70 - 216 mm (width) to 148 - 356 mm (length)
Paper Size	Built-in
Automatic Duplexing Interface	USB 2.0, Ethernet Interface (10Base-Te / 100Base-TX / 1000Base-T)
OS Support	Windows XP / Vista / 7 / 8 / 8.1 / 10 Windows Server 2003 / 2008 / 2012 / 2016 Mac OS X 10.6.8 or later Linux: CUPS Ver 1.1.23, Ver 2.0.2 Citrix: XenApp7.6/XenDesktop7.6
Dimensions Weight	393 x 375 x 285 mm 14 kg

LASER PRINTER

Increase Workgroup's Productivity at Lower Running Cost

ACULASER M320DN



Max. Resolution	Up to 1200 x 1200 dpi
Print Speed	Up to 40 ppm
Monthly Duty Cycle	50,000 pages / month
Input Paper Capacity	Standard: Up to 350 sheets Maximum: Up to 850 sheets
Standard Output Tray Capacity	250 sheets
Paper Size	A4, A5, A6, B5, LT, HLT, LGL, GLT, GLG, EXE, F4, Label, Envelope (C5, C6, DL, Com10, Monarch, ISO-B5), Custom size: from 70 - 216 mm (width) to 148 - 356 mm (length)
Automatic Duplexing Interface	Built-in USB 2.0, Ethernet Interface (10Base-Te / 100Base-TX / 1000Base-T) Windows XP / Vista / 7 / 8 / 8.1 / 10 Windows Server 2003 / 2008 / 2012 / 2016
OS Support	Mac OS X 10.6.8 or later Linux: Cups Ver 1.1.23, Ver 2.0.2 Citrix: XenApp7.6/XenDesktop7.6
Dimensions	393 x 375 x 285 mm
Weight	14 kg

Compact and Reliable Mono Printer for Print & Cost Efficiency

ACULASER M400DN



Max. Resolution	1,200 x 1,200 dpi
Print Speed	45 ppm
Monthly Duty Cycle	207,000 sheets
Input Paper Capacity	Standard: 700 sheets Maximum: 2,350 sheets
Standard Output Tray Capacity	250 sheets
Paper Size	A4, A5, A6, B5, LT, HLT, LGL, GLT, GLG, EXE, F4, Label, Envelope (C5, C6, DL, Com10, Monarch, ISO-B5), Custom size: from 70 - 216mm (width) to 148 - 356mm (length)
Automatic Duplexing Interface	Built-in Ethernet (100Base-TX/10Base-T) interface, High-speed USB 2.0 interface
OS Support	Windows® 2000, XP (32bit/64bit) / Vista (32bit/64bit) / Server 2003 (32bit/64bit) / Server 2008 (32bit/64bit), Mac OS 10.4.11 / Mac OS 10.5.8
Dimensions	393 x 426 x 324mm
Weight	14 kg

LASER PRINTER

Monochrome that Suits Diversity & Versatility

ACULASER M8100DN



Max. Resolution	1,200 x 1,200 dpi
Print Speed	Up to 40 ppm
Monthly Duty Cycle	Up to 220,000 pages per month
Input Paper Capacity	Standard: 600 sheets Maximum: 2,600 sheets
Standard Output Tray Capacity	Up to 500 sheets / Up to 750 sheets with Face-Up Tray
Paper Size	A3, A4, A5, A6, B4, B5, LT, HLT, GLT, GLG, EXE, F4, B. Envelopes: Monarch, DL, C6, C5, B5 Custom size : 70 x 148 mm - 297 x 450 mm
Automatic Duplexing Interface	Standard Hi-Speed USB 2.0, Ethernet (10Base-T/100BASE-TX/1000BASE-T)
OS Support	Windows XP, Vista, 7, 8, 8.1. Windows Server 2003, Server 2008, Server 2008R2, Server 2012, Server 2012R2, Mac OS X 10.6.8 or later, Linux Cups ver 1.1.23, ver 1.2.4
Dimensions	490 x 410 x 320 mm
Weight	21 kg

Laser Printer Consumable

Order Code	Descriptions	Yield Character	Product
TONER EPSON ACULASER MONO			
C13S050439	High Cap Toner	2,200	M2010
C13S050440	Standard Cap Toner	1,000	
C13S051170	Imaging Cartridge	20,000	
C13S053038	Fuser Unit (220-240V)	200,000	
C13S051170	Imaging Cartridge	20,000	M4000N
C13S053038	Fuser Unit (220-240V)	200,000	
C13S050520	Dev Cart	1,500	M1200
C13S050521	Dev Cart	3,000	
C13S050586	High Capacity Toner Cartridge (Bk)	8,000	M2410DN
C13S050587	Standard Capacity Toner Cartridge (Bk)	3,000	
C13S050650	High Cap Toner	2,200	M1400
C13S050652	Standard Cap Toner	1,000	
C13S051221	Imaging Cartridge	15,000	M7000N
C13S050709	Toner Cartridge	2,500	M200DN
C13S050710	Toner Cartridge (Double Pack)	2 x 2,500	
C13S050697	High Capacity Toner Cartridge	23,700	M400DN
C13S050698	Standard Capacity Toner Cartridge	12,000	
C13S051230	Photoconductor Unit	100,000	
C13S053057	Maintenance Unit	200,000	
C13S050689	High Capacity Toner Cartridge	10,000	M300D/
C13S050690	Standard Capacity Toner Cartridge	2,700	M300DN

Order Code	Descriptions	Yield Character	Product
TONER EPSON ACULASER COLOR			
C13S050245	Black Toner Cartridge	10,000	C4200DN
C13S050242	Yellow Toner Cartridge	8,500	
C13S050243	Magenta Toner Cartridge	8,500	
C13S050244	Cyan Toner Cartridge	8,500	
C13S051109	Photoconductor Unit	35,000	
C13S053021	Fuser Unit	100,000	
C13S053022	Transfer Unit	35,000	
C13S051127	High Cap Toner Cartridge Black	9,500	C3800
C13S051126	High Cap Toner Cartridge Cyan	9,000	
C13S051125	High Cap Toner Cartridge Magenta	9,000	
C13S051124	High Cap Toner Cartridge Yellow	9,000	
C13S051130	Standard Cap Toner Cartridge Cyan	5,000	
C13S051129	Standard Cap Toner Cartridge Magenta	5,000	
C13S051128	Standard Cap Toner Cartridge Yellow	5,000	
C13S053024	Transfer Unit	100,000	C3800 /
C13S053025	Fuser Unit	100,000	C2800

Order Code	Descriptions	Yield Character	Product
TONER EPSON ACULASER COLOR			
C13S051158	Toner Cartridge High Cap Yellow	6,000	C2800
C13S051159	Toner Cartridge High Cap Magenta	6,000	
C13S051160	Toner Cartridge High Cap Cyan	6,000	
C13S051161	Toner Cartridge High Cap Black	8,000	
C13S050474	Toner Cartridge (Yellow)	14,000	C9200N
C13S050475	Toner Cartridge (Magenta)	14,000	
C13S050476	Toner Cartridge (Cyan)	14,000	
C13S050477	Toner Cartridge (Black)	17,000	
C13S050478	Waste Toner Collector	18,000	
C13S051175	Photoconductor Unit (Yellow)	30,000	
C13S051176	Photoconductor Unit (Magenta)	30,000	
C13S051177	Photoconductor Unit (Cyan)	30,000	
C13S051178	Photoconductor Unit (Black)	30,000	
C13S050590	Toner Cartridge (Yellow)	6,000	C3900DN
C13S050591	Toner Cartridge (Magenta)	6,000	
C13S050592	Toner Cartridge (Cyan)	6,000	
C13S050593	Toner Cartridge (Black)	6,000	
C13S050595	Waste Toner Bottle	100,000	
C13S051201	Photoconductor Unit (Yellow)	30,000	
C13S051202	Photoconductor Unit (Magenta)	30,000	
C13S051203	Photoconductor Unit (Cyan)	30,000	
C13S051204	Photoconductor Unit (Black)	30,000	
C13S051201	Fuser Unit	100,000	
C13S050611	High Cap Toner Cartridge Yellow	1,400	C1700
C13S050612	High Cap Toner Cartridge Magenta	1,400	
C13S050613	High Cap Toner Cartridge Cyan	1,400	
C13S050614	High Cap Toner Cartridge Black	2,000	
C13S050627	Standard Cap Toner (Yellow)	2,500	C2900N
C13S050628	Standard Cap Toner (Magenta)	2,500	
C13S050629	Standard Cap Toner (Cyan)	2,500	
C13S050630	Standard Cap Toner (Black)	3,000	
C13S050631	Double Cap Toner (Black)	2 x 3,000	
C13S051211	Drum Cartridge	36,000	
C13S053043	Fuser Unit (220-240V)	50,000	
C13S050602	Toner Cartridge (Yellow)	7,500	
C13S050603	Toner Cartridge (Magenta)	7,500	
C13S050604	Toner Cartridge (Cyan)	7,500	
C13S050605	Toner Cartridge (Black)	6,500	
C13S050606	Toner Cartridge Yellow (DP)	15,000	C9300N
C13S050607	Toner Cartridge Magenta (DP)	15,000	
C13S050608	Toner Cartridge Cyan (DP)	15,000	
C13S050609	Toner Cartridge Black (DP)	13,000	
C13S050610	Waste Toner Collector	24,000	
C13S051209	Photoconductor Unit (Color)	24,000	
C13S051210	Photoconductor Unit (Black)	24,000	

LASER PRINTER

Laser Printer Consumable

Order Code	Descriptions	Yield Character	Product	Order Code	Descriptions	Yield Character	Product
TONER EPSON ACULASER MONO				TONER EPSON ACULASER MONO			
C13S050459	High Cap Toner Cartridge Black	13,700	C500DN	C13S050097	Yellow Developer Cartridge for AcuLaser	4,500	C1900/ C900
C13S050456	High Cap Toner Cartridge Yellow	13,700		C13S050098	Magenta Developer Cartridge for AcuLaser	11,250/ 45,000	
C13S050457	High Cap Toner Cartridge Magenta	13,700		C13S050099	Cyan Developer Cartridge for AcuLaser	52,500/ 210,000	
C13S050458	High Cap Toner Cartridge Cyan	13,700		C13S051083	PhotoConductor Unit for AcuLaser	6,250/ 25,000	
C13S050643	Standard Cap Toner Cartridge Black	10,500		C13S053009	Transfer Unit for AcuLaser	1,500	
C13S050640	Standard Cap Toner Cartridge Yellow	7,500		C13S050101	Waste Toner Collector for AcuLaser	1,500	
C13S050641	Standard Cap Toner Cartridge Magenta	7,500		C13S050155	Yellow Developer Cartridge for AcuLaser	1,500	
C13S050642	Standard Cap Toner Cartridge Cyan	7,500		C13S050156	Magenta Developer Cartridge for AcuLaser	1,500	
C13S051227	Photoconductor Unit Black	50,000		C13S050157	Cyan Developer Cartridge for AcuLaser	8,500	
C13S051224	Photoconductor Unit Yellow	50,000		C13S050091	Toner Cartridge Black for AcuLaser	6,000	C4000
C13S051225	Photoconductor Unit Magenta	50,000	C13S050088	Toner Cartridge Yellow for AcuLaser	6,000		
C13S051226	Photoconductor Unit Cyan	50,000	C13S050089	Toner Cartridge Magenta for AcuLaser	6,000		
C13S050664	Waste Toner Collector	25,000	C13S050090	Toner Cartridge Cyan for AcuLaser	30,000		
C13S050402	Staple Cartridge	5,000	C13S051081	PhotoConductor Unit for AcuLaser	25,000		
C13S053048	Transfer Unit	150,000	C13S053006	Transfer Unit for AcuLaser	100,000		
C13S051020	Imaging Cartridge	4,500	C13S053007	Fuser Unit 220 for AcuLaser	10,000	C4000/ C4100/ C3000N	
C13S050005	Developer Cartridge	3,000	C13S050149	Toner Cartridge Black	8,000		
C13S051029	Photoconductor Unit	20,000	C13S050148	Toner Cartridge Yellow	8,000	AL-C4100	
C13S050010	Toner Cartridge	6,000	C13S050147	Toner Cartridge Magenta	8,000		
C13S051055	Photoconductor Unit	20,000	C13S050146	Toner Cartridge Cyan	30,000	EPL-C8000 /C8200	
C13S050087	Developer Cartridge	6,000	C13S051093	Photoconductor Unit	30,000		
C13S050095	Developer Cartridge [3K]	3,000	C13S053012	Fuser Unit 220	100,000		
C13S050167	Developer Cartridge	3,000	C13S050078	Toner Cartridge Black	4,500	EPL-C8000/ C8200/ C8500/ C8600	
C13S051099	Photoconductor Unit	20,000	C13S050075	Toner Cartridge Yellow	6,000		
C13S050166	Developer Cartridge	6,000	C13S050076	Toner Cartridge Magenta	6,000		
C13S051056	Imaging Cartridge	8,500	C13S050077	Toner Cartridge Cyan	6,000		
C13S051069	Imaging Cartridge	7,600	C13S051061	PhotoConductor Unit	6,000		
C13S051070	Imaging Cartridge	15,000	C13S052002	Fuser Oil Roll	20,000		
C13S051111	Imaging Cartridge	17,000	C13S050020	Waste Toner Collector	20,000		
C13S053017	Fuser Unit	200,000	C13S050079	Toner Cartridge for AcuLaser (Yellow)	6,000		
C13S051077	Imaging Cartridge	10,000	C13S050080	Toner Cartridge for AcuLaser (Magenta)	6,000		
C13S051091	Imaging Cartridge	10,000	C13S050081	Toner Cartridge for AcuLaser (Cyan)	6,000		
C13S051035	Imaging Cartridge	10,000	C13S050082	Toner Cartridge for AcuLaser (Black)	5,500		
C13S051060	Imaging Cartridge	23,000	C13S051073	Photo Conductor for AcuLaser	12,500/ 50,000		
C13S050033	Toner Cartridge for AcuLaser (Black)	6,000	C13S051082	PhotoConductor for AcuLaser	12,500/ 50,000		
C13S050034	Toner Cartridge for AcuLaser (Yellow)	6,000	C13S050213	Toner Cartridge Black	4,500	AL-C3000N	
C13S050035	Toner Cartridge for AcuLaser (Magenta)	6,000	C13S050210	Toner Cartridge Yellow	3,500		
C13S050036	Toner Cartridge for AcuLaser (Cyan)	21,000	C13S050211	Toner Cartridge Magenta	3,500		
C13S052003	Fuser Oil Roll for AcuLaser	7,500/ 30,000	C13S050212	Toner Cartridge Cyan	3,500		
C13S050037	Waste Toner Collector for AcuLaser	7,500/ 30,000	C13S050198	Toner Cartridge Black	15,000		
C13S051072	PhotoConductor Kit for AcuLaser	30,000/ 130,000	C13S050197	Toner Cartridge Cyan	12,000		
C13S053001	Transfer Belt Unit AcuLaser	100,000	C13S050196	Toner Cartridge Magenta	12,000		
C13S053003	Fuser Kit (220V) AcuLaser	4,500	C13S050195	Toner Cartridge Yellow	12,000		
C13S050100	Black Developer Cartridge for AcuLaser	4,500	C13S051105	Photoconductor Unit	30,000		
			C13S050194	Waste Toner Collector	24,000		
			C13S050190	Toner Cartridge Black	4,000		
			C13S050189	Toner Cartridge Cyan	4,000		
			C13S050188	Toner Cartridge Magenta	4,000		
			C13S050187	Toner Cartridge Yellow	4,000		
			C13S050193	Toner Cartridge Cyan	1,500		
			C13S050192	Toner Cartridge Magenta	1,500		
			C13S050191	Toner Cartridge Yellow	1,500		
			C13S051104	Photoconductor Unit	14,000		
			C13S050287	Color Economy Pack	3 x 1,500		

BUSINESS & PHOTO SCANNER

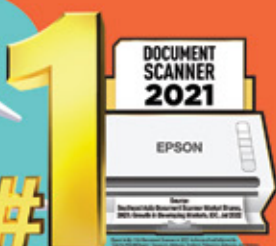

BUSINESS & PHOTO SCANNER

MENGAPA MEMILIH EPSON SCANNER ?

Dapatkan kecepatan dan kualitas terbaik dengan berbagai pilihan scanner terbaru dari Epson yang mampu menangkap semua detail untuk memenuhi kebutuhan bisnis Anda. Dengan fitur dan teknologi canggih milik Epson, Scanner ini memberi Anda lebih banyak daya, volume lebih tinggi, dan kecepatan lebih cepat untuk produktivitas lebih baik.

CCD System

Pemindai memanfaatkan Charge-Coupled Device (CCD) scanning system, memantulkan dokumen yang diterangi dari serangkaian cermin melalui lensa ke sensor

kelebihan dari Teknologi CCD

- Kecepatan pemindaian lebih tinggi
- lebih jelas dan lebih detail untuk pemindaian film
- Kedalaman bidang yang lebih besar saat memindai dokumen atau objek 3D yang tidak rata pada kaca pemindai
- Kepadatan optik lebih tinggi



CIS Scanner

Text on "contactless" area is not clear



CCD Scanner

Text on "contactless" area is clear

ReadyScan LED Technology

Dengan Teknologi ReadyScan LED, pemindaian dimulai secara instan tanpa memerlukan waktu pemanasan. Teknologi ini ramah lingkungan karena bebas merkuri, disipasi panas rendah dan membutuhkan konsumsi daya yang lebih rendah.



BUSINESS & PHOTO SCANNER

A4 Portable Sheet-Fed Scanner

WORKFORCE ES-50/ES-60W



red dot award 2019
winner

Scanner Type	A4 Sheet-fed colour scanner
Sensor Type	Contact Image Sensor (CIS)
Light Source	RGB LED
Optical Resolution	600 x 600 dpi
Scan Area	A4 (support F4)
Document Size (Min)	50.8 x 50.8 mm
(Max)	216 x 1,828.8 mm
Supported Paper Weight	35 - 270 g/m2
ADF Capacity	1 sheet
Scanning Speed	5.5 sec, 4.0 sec [Battery] / 5.5 sec [USB Bus Powered] [ES-50W/60W]
Operating System	Windows 7 / 8 / 8.1 / 10 / Server 2003 / 2008 / 2012 / 2016 Mac OS X 10.6.8 or later
Interface	USB 2.0 (Micro-B), Wi-Fi [ES-60W]
Dimensions	272 x 47 x 33.8 mm
Weight	270g [ES-50], 300g [ES-60W]

WORKFORCE DS-C330



Scanner Type	A4 sheet-fed, one-pass duplex scanner
Sensor Type	Contact Image Scanner (CIS) x 2
Light Source	RGB LED x 2
Optical Resolution	600 x 600 dpi
Scan Area	A4 (support F4)
Document Size (Min)	50.8 x 50.8 mm
(Max)	215.9 x 3,048 mm
Supported Paper Weight	40-127 g/m2 [Postcard: 40-413 g/m2]
ADF Capacity	20 sheets (80 g/m2)
Scanning Speed	
Resolution (Colour/Monochrome)	Simplex / Duplex
	30 ppm / 60 ipm
	5 ppm / 10 ipm
Operating System	Windows XP/ Vista / 7 / 8 / 8.1 / 10 Mac OS X 10.6.8 or later
Interface	USB 2.0
Dimensions	296 x 104 x 125 mm
Weight	1,8 kg

BUSINESS & PHOTO SCANNER

WORKFORCE DS-360W



Scanner Type	A4 sheet-fed, one-pass duplex scanner
Sensor Type	Contact Image Scanner (CIS)
Light Source	RGB LED
Optical Resolution	600 x 600 dpi
Scan Area	A4 (support F4)
Document Size (Min)	50.8 x 70 mm
(Max)	216 x 1.117 mm
Supported Paper Weight	51.8-128 g/m ² (Postcard: 128-230 g/m ²)
ADF Capacity	20 sheets (80 g/m ²)
Scanning Speed	25 ppm/50 ipm (AC Adapter/Built-in Battery3), 5.0 ppm/10 ipm (USB 3.0 Bus Power)
Operating System	Windows XP/ Vista / 7 / 8 / 8.1 / 10 Mac OS X 10.6.8 or later
Interface	USB 3.0, Wi-Fi, Wi-Fi Direct
Dimensions	288 x 88.5 x 67 mm
Weight	1,3 kg

A4 Sheet-Fed Scanners

WORKFORCE DS-410



Scanner Type	A4 Sheet-fed, one-pass duplex colour scanner
Sensor Type	Contact Image Sensor (CIS) x 2
Light Source	RGB LED
Optical Resolution	600 x 600 dpi
Scan Area	A4 (support F4)
Document Size (Min)	50.8 x 50.8 mm
(Max)	215.9 x 3,048 mm
Supported Paper Weight	50 - 209 g/m ² (A8 or less : 127 - 209 g/m ²)
ADF Capacity	50 sheets (80g/m ²)
Scanning Speed	26 ppm / 52 ipm (Monochrome, Colour)
Operating System	Windows XP / Vista / 7 / 8 / 8.1 / 10 / Server 2003 / 2008 / 2012 / 2016, Mac OS X 10.6.8 or later
Interface	USB2.0
Dimensions	297 x 152 x 154 mm
Weight	2,5kg

BUSINESS & PHOTO SCANNER

A4 Sheet-Fed Scanners



WORKFORCE DS-530II



Scan up to A3*



Scan from 279mm to 413mm



One Pass Duplex Scanning

Scanner Type	A4 Sheet-fed, one-pass duplex colour scanner
Sensor Type	Contact Image Scanner (CIS)
Light Source	RGB LED
Optical Resolution	600 x 600 dpi
Document Size (Min)	50.8 x 50.8 mm
(Max)	215.9 x 6096 mm
Supported Paper Weight	27 - 413 g/m ² (A8 or less 127 - 413 g/m ²)
ADF Capacity	50 sheets (80g/m ²)
Scanning Speed	
Resolution (Colour/Grayscale/Mono)	Simplex / Duplex
	35 ppm / 70 ipm
	12 ppm / 24 ipm
Operating System	Windows XP / Vista / 7 / 8 / 8.1 / 10 / Server 2003 / Server 2008 / Server 2012 / Server 2016
	Mac OS X 10.6.8 or later
Interface	USB 3.2 Gen 1
Dimensions	296 x 169 x 176 mm
Weight	3.7 kg



WORKFORCE DS-570WII



Scan up to A4



Scan from 279mm to 413mm



One Pass Duplex Scanning



Wi-Fi*



Epson Smart Panel*

Scanner Type	A4 Sheet-fed, one-pass duplex colour scanner
Sensor Type	Contact Image Scanner (CIS)
Light Source	RGB LED
Optical Resolution	600 x 600 dpi
Document Size (Min)	50.8 x 50.8 mm
(Max)	215.9 x 6096 mm
Supported Paper Weight	27 - 413 g/m ² (A8 or less : 127 - 413 g/m ²)
ADF Capacity	50 sheets (80g/m ²)
Scanning Speed	
Resolution (Colour/Grayscale/Mono)	Simplex / Duplex
	35 ppm / 70 ipm
	12 ppm / 24 ipm
Operating System	Windows XP / Vista / 7 / 8 / 8.1 / 10 / Server 2003 / Server 2008 / Server 2012 / Server 2016
	Mac OS X 10.6.8 or later
Interface	USB 3.2 Gen 1, Wi-Fi (802.11 b/g/n)
Dimensions	296 x 169 x 176 mm
Weight	3.7 kg

BUSINESS & PHOTO SCANNER



WORKFORCE ES-580W



Scanner Type	A4 Sheet-fed, one pass duplex colour scanner
Sensor Type	Colour Contact Image Sensor (CIS)
Light Source	RGB LED
Optical Resolution	600 x 600 dpi
Document Size (Min)	50.8 x 50.8 mm
(Max)	215.9 x 6096 mm
Supported Paper Weight	27 - 413 g/m ²
ADF Capacity	100 sheets (80 g/m ²)
Scanning Speed	
Resolution (A4, Colour/Monochrome)	300 dpi 35 ppm / 70 ipm 600 dpi 12 ppm / 24 ipm
Operating System	Windows 7 / 8 / 8.1 / 10 / Server 2003 / Server 2008 / Server 2012 / Server 2016 / Server 2019 Mac OS X 10.6.8 or later
Interface	USB 3.2 Gen 1, Wi-Fi (802.11 b/g/n), Wi-Fi Direct (max 8 connections)
Dimensions	296 x 169 x 167 mm
Weight	3.7kg



WORKFORCE DS-730N



Scanner Type	Sheet-fed, one pass duplex colour scanner
Sensor Type	Colour Contact Image Sensor (CIS)
Light Source	RGB LED
Optical Resolution	600 x 600 dpi
Document Size (Min)	50.8 x 50.8 mm
(Max)	215.9 x 6096 mm
Supported Paper Weight	27 - 413 g/m ²
ADF Capacity	100 sheets (80 g/m ²)
Scanning Speed	
Resolution (A4, Colour/Monochrome)	300 dpi 40 ppm / 80 ipm 600 dpi 12 ppm / 24 ipm
Operating System	Windows XP SP3 / Vista / 7 / 8 / 8.1 / 10 / Server 2003 / Server 2008 / Server 2012 / Server 2016 / Server 2019, Mac OS X 10.6.8 or later
Interface	USB2.0 and Ethernet (1000BASE-T/100BASE-TX/10BASE-T)
Dimensions	296 x 169 x 167 mm
Weight	3.6kg

BUSINESS & PHOTO SCANNER

A4 Sheet-Fed Scanners



WORKFORCE DS-770II



Scan up to A3*

Scan from 21gsm to 413gsm

One Pass Duplex Scanning

Scanner Type	A4 Sheet-fed, one pass duplex colour scanner
Sensor Type	Contact Image Sensor (CIS)
Light Source	RGB LED
Optical Resolution	600 x 600 dpi
Document Size (Min)	50.8 x 50.8 mm
(Max)	215.9 x 6096 mm
Supported Paper Weight	27 - 413 g/m ² (A8 or less 127 - 413 g/m ²)
ADF Capacity	100 sheets (80g/m ²)
Scanning Speed	
Resolution (Colour/Grayscale/Mono)	Simplex / Duplex
200/300 dpi	45 ppm / 90 ipm
600 dpi	12 ppm / 24 ipm
Operating System	Windows XP / Vista / 7 / 8 / 8.1 / 10 / Server 2003 / Server 2008 / Server 2012 / Server 2016
Interface	USB 3.2 Gen 1
Dimensions	296 x 169 x 176 mm
Weight	3.7 kg

WORKFORCE DS-790WN



Scan up to A3*

Scan 600 dpi

USB 3.0 iVo-powered

RGB LED Lighting

NEW PRODUCT



Scanner Type	A4 sheet-fed, one-pass duplex colour scanner
Sensor Type	Colour Contact Image Sensor (CIS) x 2
Light Source	RGB LED x 2
Optical Resolution	600 x 600 dpi
Document Size (Min)	50.8 x 50.8 mm
(Max)	215.9 x 6096 mm
Supported Paper Weight	27 - 413 g/m ² (A8 or less 127 - 413 g/m ²)
ADF Capacity	100 sheets (80 g/m ²)
Scanning Speed	
Resolution (Colour/Grayscale/Mono)	Simplex / Duplex
200/300 dpi	45 ppm / 90 ipm
600 dpi	12 ppm / 24 ipm
Operating System	Windows XP / Vista / 7 / 8 / 8.1 / 10 / 11, Server 2003 / 2008 / 2012 / 2019 / 2022 Mac OS X 10.6.8 or later
Interface	USB 3.2 Gen 1, Ethernet [1000BASE-T/100BASE-TX/10BASE-T], Wi-Fi (IEEE 802.11 b/g/n), Wi-Fi Direct (max 8 connections), USB 2.0 Host
Dimensions	296 x 169 x 167 mm
Weight	3,7kg

BUSINESS & PHOTO SCANNER



WORKFORCE DS-870



Scanner Type	A4 Sheet-fed, one pass duplex colour scanner
Sensor Type	Contact Image Sensor (CIS)
Light Source	RGB LED
Optical Resolution	600 x 600 dpi
Document Size (Min)	50.8 x 50.8 mm
(Max)	215.9 x 6096 mm
Supported Paper Weight	27 - 413 g/m ² [A8 or less 127 - 413 g/m ²]
ADF Capacity	100 sheets [80 g/m ²]
Scanning Speed	
Resolution (Colour/Greyscale/Mono)	Simplex / Duplex
	200/300 dpi
	600 dpi
Operating System	Windows XP / Vista / 7 / 8 / 8.1 / 10 Mac OS X 10.6.8 or later
Interface	USB 3.0
Dimensions	296 x 169 x 167 mm
Weight	3,6kg



WORKFORCE DS-970



Scanner Type	A4 Sheet-fed, one pass duplex colour scanner
Sensor Type	Contact Image Sensor (CIS)
Light Source	RGB LED
Optical Resolution	600 x 600 dpi
Scan Area	A4 [support F4]
Document Size (Min)	50.8 x 50.8 mm
(Max)	215.9 x 6096 mm
Supported Paper Weight	27 - 413 g/m ² [A8 or less 127 - 413 g/m ²]
ADF Capacity	100 sheets [80 g/m ²]
Scanning Speed	
Resolution (Colour/Greyscale/Mono)	Simplex / Duplex
	300 dpi
	600 dpi
Operating System	Windows XP / Vista / 7 / 8 / 8.1 / 10 Mac OS X 10.6.8 or later
Interface	USB 3.0
Dimensions	296 x 169 x 167 mm
Weight	3,6kg

BUSINESS & PHOTO SCANNER

A3 Sheet-Fed Scanners

WORKFORCE DS-30000



Scan up to
A3



Scan
600 dpi



USB 3.0
Bus-powered



White LED
Lighting



Scanner Type

A3 sheet-fed, one-pass duplex colour scanner

Sensor Type

Colour Contact Image Sensor (CIS)

Light Source

White LED

Optical Resolution

600 x 600 dpi

Document Size (Min)

50.8 x 69 mm

(Max)

304.8 x 5.588 mm

Supported Paper Weight

27-413 g/m²

ADF Capacity

A4 : 120 sheets, A3 : 60 sheets (80 g/m²)

Scanning Speed

Simplex / Duplex

70 ppm / 140 ipm

22 ppm / 44 ipm

Operating System

Windows XP SP3 / Vista / 7 / 8 / 8.1 / 10

Windows Server 2003 / 2008 / 2012 / 2016 /

2019, Mac OS X 10.6.8 or later

Interface

USB 3.0

Dimensions

371 x 208 x 219 mm

Weight

5.8 kg



Scan up to
A3



Scan
600 dpi



USB 3.0
Bus-powered



White LED
Lighting



WORKFORCE DS-32000

Scanner Type

A3 sheet-fed, one-pass duplex colour scanner

Sensor Type

Colour Contact Image Sensor (CIS)

Light Source

White LED

Optical Resolution

600 x 600 dpi

Document Size (Min)

50.8 x 69 mm

(Max)

304.8 x 5.588 mm

Supported Paper Weight

20 - 413 (80 g/m²)

ADF Capacity

A4 120 sheets, A3 : 60 sheets

Delicate Feed Mode : 20 sheets (A4),
10 sheets (A3)

Scanning Speed

Simplex / Duplex

90 ppm / 180 ipm

26 ppm / 52 ipm

Operating System

Windows XP SP3 / Vista / 7 / 8 / 8.1 / 10

Windows Server 2003 / 2008 / 2012 / 2016 /

2019, Mac OS X 10.6.8 or later

Interface

USB 3.0

Dimensions

371 x 167 x 245mm

Weight

6.9 kg

BUSINESS & PHOTO SCANNER

A4 Flatbed Business Scanner

WORKFORCE DS-1630



Scan up to A4



Scan 1200 dpi



RGB LED Lighting



USB 2.0 Bus-powered



Scanner Type	Flatbed colour image scanner with ADF
Sensor Type	Colour Contact Image Sensor (CIS)
Light Source	RGB LED
Optical Resolution	1200 dpi x 1200 dpi
Document Size (Min)	89 x 127 mm (ADF Simplex), 89 x 170 mm (ADF Duplex)
(Max)	216 x 297 mm (Flatbed), 215.9 x 3048 mm (ADF Simplex)
Supported Paper Weight	50 - 120 g/m ²
ADF Capacity	50 sheets (80g/m ²)
Scanning Speed	Colour
Flatbed	200-300 dpi approx. 7.0 sec, 1.4 msec/line 600 dpi approx. 26 sec, 3.2 msec/line
ADF	200-300 dpi 25 ppm / 10 ipm 600 dpi 9.0 ppm / 6.0 ipm
Operating System	Windows XP SP3 / Vista / 7 / 8 / 8.1 / 10 Windows Server 2003 / 2008 / 2012 / 2016 / 2019, Mac OS X 10.6.8 or later
Interface	USB 3.0
Dimensions	450x318x121mm
Weight	4.1kg

WORKFORCE DS-6500



Scan up to A4



Scan 1200 dpi



USB 3.0 Bus-powered



White LED Lighting



Scanner Type	A4 Flatbed colour image scanner with duplex ADF
Sensor Type	4 Line Colour CCD
Light Source	White LED
Optical Resolution	1200 dpi x 1200 dpi
Document Size (Min)	100 mm x 148 mm (ADF)
(Max)	215.9 mm x 1016 mm (ADF)
Supported Paper Weight	50 - 128 g/m ² (<A6 60 - 190 g/m ²)
ADF Capacity	100 sheets (80 g/m ²)
Scanning Speed	Colour 24-bit
Flatbed	300 dpi approx. 8.0 sec, 0.6 msec/line 600 dpi approx. 22 sec, 1.69 msec/line
ADF	200-300 dpi 25 ppm / 50 ipm 600 dpi 4 ppm / 8 ipm
Operating System	Windows XP SP3 / Vista / 7 / 8 / 8.1 / 10 Windows Server 2003 / 2008 / 2012 / 2016 / 2019, Mac OS X 10.6.8 or later
Interface	Hi-Speed USB 2.0, Ethernet (Optional)
Dimensions	217 x 495 x 360 mm
Weight	9.8 kg

BUSINESS & PHOTO SCANNER

A4 Flatbed Business Scanner

WORKFORCE DS-7500



Scan up to A4



Scan 1200 dpi

USB 2.0
Bus-poweredWhite LED
Lighting

Scanner Type

A4 Flatbed colour image scanner with duplex ADF

Sensor Type

4 Line Colour CCD

Light Source

White LED

Optical Resolution

1200 dpi x 1200 dpi

Document Size (Min)

100 mm x 148 mm [ADF]

(Max)

215.9 mm x 1016 mm [ADF]

Supported Paper Weight

50 - 128 g/m² (<A6 60 - 190 g/m²)

ADF Capacity

100 sheets (80 g/m²)

Scanning Speed

Colour 24-bit

Flatbed

300 dpi

8.0 sec, 0.6 msec/line

600 dpi

22 sec, 1.69 msec/line

ADF

200-300 dpi

40 ppm / 80 ipm

600 dpi

8 ppm / 13 ipm

Operating System

Windows XP SP3 / Vista / 7 / 8 / 8.1 / 10
Windows Server 2003 / 2008 / 2012 / 2016 /
2019, Mac OS X 10.6.8 or later

Interface

Hi-Speed USB 2.0, Ethernet (Optional)

Dimensions

217 x 495 x 360 mm

Weight

9.8 kg

A3 Flatbed Business Scanner

WORKFORCE DS-50000



Scan up to A3



Scan 600 dpi

USB 2.0
Bus-powered

Scanner Type

A3 Flatbed colour image scanner

Sensor Type

4 Line Colour CCD

Light Source

White LED

Optical Resolution

600 dpi x 600 dpi

Document Size (Max)

A3 (11.7" x 17")

Scanning Speed

Colour 24-bit

Flatbed

300 dpi

approx. 4.0 sec, 0.351 msec/line

600 dpi

approx. 10 sec, 0.702 msec/line

Operating System

Windows XP SP3 / Vista / 7 / 8 / 8.1 / 10
Windows Server 2003 / 2008 / 2012 / 2016 /
2019, Mac OS X 10.6.8 or later

Interface

Hi-Speed USB 2.0, Ethernet (Optional)

Dimensions

640x468x156mm

Weight

14.8 kg

BUSINESS & PHOTO SCANNER

WORKFORCE DS-60000



Scan up to A3



Scan 600 dpi



USB 2.0 Bus-powered



White LED Lighting



Scanner Type	A3 Flatbed colour image scanner with ADF
Sensor Type	4 Line Colour CCD
Light Source	White LED
Optical Resolution	600 dpi x 600 dpi
Document Size (Min)	68 mm x 120 mm
(Max)	297 mm x 2540 mm
Supported Paper Weight	35 - 128 g/m ² (<A6 60 - 190 g/m ²)
ADF Capacity	200 sheets (80 g/m ²)
Scanning Speed	Colour 24-bit
Flatbed	approx. 4.0 sec, 0.351 msec/line
ADF	approx. 10 sec, 0.702 msec/line
200-300 dpi	40 ppm / 80 ipm
600 dpi	7.5 ppm / 15 ipm
Operating System	Windows XP SP3 / Vista / 7 / 8 / 8.1 / 10 Windows Server 2003 / 2008 / 2012 / 2016 / 2019, Mac OS X 10.6.8 or later
Interface	Hi-Speed USB 2.0, Ethernet (Optional)
Dimensions	640x552x289mm
Weight	26.9 kg

WORKFORCE DS-70000



Scan up to A3



Scan 600 dpi



USB 2.0 Bus-powered



White LED Lighting



Scanner Type	A3 Flatbed colour image scanner with ADF
Sensor Type	4 Line Colour CCD
Light Source	White LED
Optical Resolution	600 dpi x 600 dpi
Document Size (Min)	68 mm x 120 mm
(Max)	297 mm x 2540 mm
Supported Paper Weight	35 - 128 g/m ² (<A6 60 - 190 g/m ²)
ADF Capacity	200 sheets (80 g/m ²)
Scanning Speed	Colour 24-bit
Flatbed	approx. 4.0 sec, 0.351 msec/line
ADF	approx. 10 sec, 0.702 msec/line
200-300 dpi	70 ppm / 140 ipm
600 dpi	12 ppm / 24 ipm
Operating System	Windows XP SP3 / Vista / 7 / 8 / 8.1 / 10 Windows Server 2003 / 2008 / 2012 / 2016 / 2019, Mac OS X 10.6.8 or later
Interface	Hi-Speed USB 2.0, Ethernet (Optional)
Dimensions	289 x 640 x 552 mm
Weight	26.9 kg

BUSINESS & PHOTO SCANNER

A4 Photo Scanners

PERFECTION V3911



Scan up to A4



Scan 4800 x 4800 dpi



RGB LED Lighting



USB 2.0 Bus-powered



Scanner Type	A4 Flatbed Colour Image Scanner	
Light Source	RGB LED	
Optical Resolution	4,800 x 4,800 dpi	
Output Resolution	50 – 4,800 dpi (in 1 dpi increments), 7,200 dpi, 9,600 dpi	
Document Size	216 x 297 mm	
Scanning Speed	DPI	Speed
Reflective Scanning	Monochrome	
	300	10 sec
	600	12 sec
24 bit Colour	1,200	37 sec
	300	10 sec
	600	29 sec
Operating System	1,200	103 sec
	Windows 7 / 8 / 8.1 / 10 / 11, Server 2003 / 2008 / 2012 / 2016 / 2019	
	Mac OS X 10.11 or later	
Interface	USB 2.0	
Dimensions	249 x 364 x 39 mm	
Weight	1.4 kg	

PERFECTION V850



Scan up to A4



Scan 6400 x 9600 dpi



White LED Lighting



USB 2.0 Bus-powered



Scanner Type	Flatbed colour image scanner	
Light Source	White LED	
Optical Resolution	Main 6,400 dpi x Sub 9,600 dpi (Film Scanning with Film Holder)	
Output Resolution	25 to 12,800 dpi (in 1 dpi increments)	
Document Size	Up to 216 x 297 mm	
Reflective Scanning	Transparency	
	Up to 203 x 254 mm, 35mm x 18 frames strip film, 35mm x 12 frames mounted film, [6 x 20cm] x 1 frame Medium format, [4" x 5"] x 1 frame, Up to 8" x 10" (with film area guide)	
	DPI	Speed
Scanning Speed	300	6 sec
	300	12 sec
	300	12 sec
Operating System	Microsoft Windows XP / Vista / 7 / 8 / 8.1 / 10	
	Mac OS X 10.6.8 or later	
	USB 2.0	
Interface	USB 2.0	
Dimensions	308 x 503 x 152.5 mm	
Weight	6.6 kg	

BUSINESS & PHOTO SCANNER

A3 Flatbed Business Scanner

EXPRESSION 13000XL



Scanner Type	A3 Flatbed Colour Image Scanner
Sensor Type	6-line Colour CCD
Light Source	White LED
Optical Resolution	2400 x 4800 dpi
Output Resolution	50 - 6400 dpi (1 dpi increments)
Document Size (Max)	310 x 437 mm [12.2 x 17.2"] (Flatbed) 309 x 420 mm [12.2 x 16.5"] (TPU)
Film Capacity	35 mm film x 48 Frames (Strip Film Holder) 35 mm film x 30 Frames (Mounted Film Holder)
Scanning Speed	A4 300 dpi Colour/BW 12 sec
Operating System	Windows XP / Vista / 7 / 8 / 8.1 / 10 / Server 2003/2008/2012, Mac OS X 10.6.8 or later
Interface	USB 2.0
Dimensions	656 x 458 x 158 mm
Weight	14.3 kg

Manage your Documents/Photos Effortlessly

Epson ScanSmart*

Photo

Large originals can be scanned and stitched into a single image with Epson ScanSmart. This software can also perform automatic enhancements to photos and save your files into a variety of formats.

*Only applicable to V30 and V850



Document

Simplify your workflow with Epson ScanSmart. Review and edit your scans to rotate, delete, reorder or remove unnecessary pages. Save with automatic file and folder name by OCR detection for increased productivity.

*Only applicable to ES-60 and ES-60W

Epson DocumentScan App



Scan documents with your mobile devices and share it via email, through other apps or save it to selected cloud services such as Box, DropBox, Evernote®, Google® Drive™ and Microsoft® OneDrive®.

Easy Photo Scan

Through a simple user interface, users can easily scan, view, edit, save and transfer scanned documents via Easy Photo Scan. 8 simple photo editing functions such as Rotation, Auto and Manual Enhance, Soft Focus and Red Eye Correction are also available for users to enhance and correct their photos as desired. The preview mode and thumbnail mode allow users to easily choose, edit and preview photos within the application.

Post-scan destinations, including local folder, Web Folder, email, Facebook, Picasa™, Evernote® and SugarSync®, are easily accessible through the software.

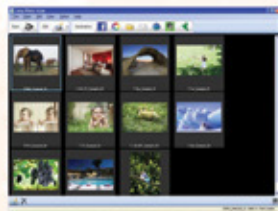

Document Capture Pro**



Document Capture Pro

Easily scan, view, edit, save and transfer scanned documents. The software recognises barcodes, characters and blank pages in scanned documents for batch separation. It allows you to create up to 30 customised job settings, with the option to assign shortcuts of the scan jobs to the scanner's operation panel to simplify scan workflow. With the built-in OCR capability, searchable PDF files can be created and documents can be saved into editable Microsoft Office formats. In addition, device and documents can be secured through password protection, by locating and tracking documents using the Advanced Log function.

**Limited functionality for Mac version of Document Capture software.

Document Capture Pro Server***



Document Capture Pro Server

Document Capture Pro Server helps to centralise your scanning and manage your fleet of scanners without the need to install drivers on individual computers.

Document Capture Pro Server - Authentication Edition secures your scanner by limiting usage based on user list. Link the scanner to your directory services for automatic syncing of the user list and the Email server to enable Scan to Email, alerts, and reporting functions.

***Only for Windows Server OS.

InstantMark OMR Software

An affordable Optical Mark Recognition (OMR) solution that provides fast and accurate detection of data from optical answer sheets used for tests, assessments, surveys and other questionnaires. It allows users to create or use existing form templates for their projects too.

Presto! Bizcard 5

A business card management solution that keeps a digital database of your business contacts. Information is extracted from the business cards by OCR.

BUSINESS & PHOTO SCANNER

Scanner Functions

Photo

Photo Enhancement

Inject new life into faded films and photos. Restore original colours of faded photos to make them look as good as new with colour restoration.



Before Colour Restoration



After Colour Restoration

Built-in Transparency Unit with Film Holder

Selected Epson photo scanners feature a built-in transparency unit with film holder which allows users to conveniently digitise precious and fragile photo films and slides.



Document

Text Enhancement

Improves text recognition when scanning text documents, whether in colour, greyscale or black-and-white. Removes background for better clarity, which is especially useful for double-sided printed documents.



Text Enhancement OFF

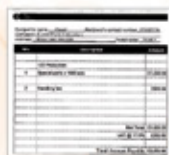

Text Enhancement ON

Document Skew Correction

Automatically adjusts and straightens scanned images.

Colour Enhancement & Colour Dropout

Remove or enhance the visibility of ink signatures such as "Confidential" and "Urgent" stamps. Users can pick one of the preset colours, all colours except black), or use the customised settings to dropout or enhance up to 5 colours of your choice with a single scan. Up to 10 preset colours can be saved for reuse.



Automatic Feeding Mode

The Automatic Feeding Mode enables large volumes of documents to be scanned continuously. In addition, this mode allows you to scan documents one at a time without needing to arrange them by size and they will be saved into a single PDF.



Double Feed Detection Skip Function

Activate the Double Feed Detection Skip function to scan documents with stickers and labels.



Book Spine Correction

Scans are corrected for shadow and curvature around book spines for better readability and clarity of texts and images.



Paper Protection Function

Upon detection of abnormal paper feeding or stapled/folded paper, the paper feed will be stopped immediately, which prevents damage to your important documents.



Epson OCR Feature

This OCR add-on allows users to create searchable PDF files and automatically straighten and orientate documents based on character recognition.

PDF Security

Advanced PDF Security features are bundled with document scanners to prevent confidential documents from being accessed, edited or printed by unauthorised users. Passwords can be used to secure the PDF files.

Auto Area Segmentation (AAS)

This feature is useful when user is performing a black-&-white scan on documents with pictures and graphs. AAS segments a scanned document which has both text and image into "Text Area" and "Image Area". The "Text Area" is scanned in black-&-white and "Image Area" is scanned in halftone.

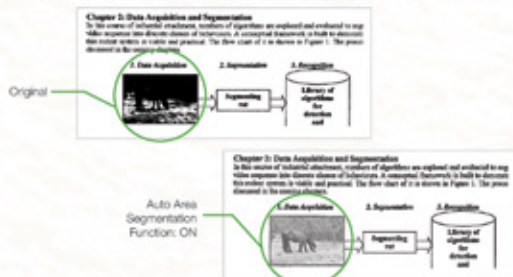

EPSON

SPEED UP YOUR BUSINESS WITH RELIABILITY YOU CAN TRUST.

Epson's latest scanner range delivers the speed and reliability for every business need. Equipped with advanced technology exclusive to Epson, these scanners enhance your business productivity, higher volume and faster speed, exceeding expectations.



3LCD PROJECTOR



3LCD PROJECTOR

MENGAPA MEMILIH 3LCD PROJECTOR ?

Projektor Epson 3LCD menghadirkan warna-warna menakjubkan dengan tingkat kecerahan yang seimbang, realistis, dan hasil gambar yang lebih hidup. Tidak heran jika proyektor Epson adalah pilihan utama masyarakat.



EPSON 3LCD TECHNOLOGY UNTUK WARNA CERAH & LEBIH NYATA

3LCD projectors offer brighter and more accurate as they produce different shades and hues by filtering, then mixing beams of the three primary colours (red, green and blue).

In a 3LCD projector, white light is first split into the three beams of primary colours. Each beam is then filtered through its own LCD that will give each individual pixel of the image its exact brightness for each colour. The colour beams are then perfectly recombined in a prism before being projected out as a complete image.

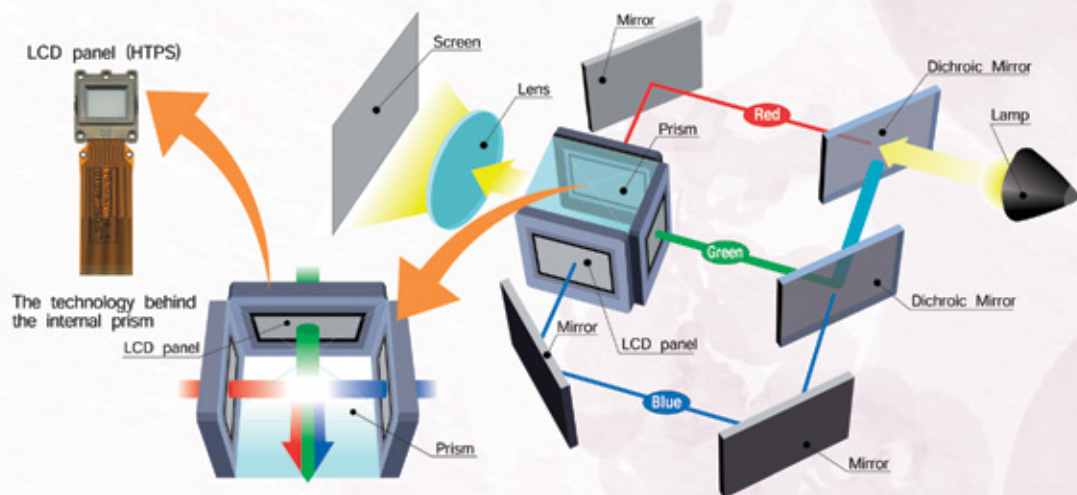

3LCD PROJECTOR

Small Sized Rooms

3LCD PROJECTOR

EB-E01



Brightness 3,300 lm	Resolution XGA	Contrast 15,000:1
Light Source Life 6,000/12,000 hrs	Keystone ±30° (V) / ±30° (H)	Connectivity USB Type-B x 1, VGA x 1, HDMI x 1
Network N/A	Power Consumption 327W / 225W	Weight 2.4 kg



12,000 Hours
Lamp Life in Eco Mode



Split Screen

EB-X06



Brightness 3,600 lm	Resolution XGA	Contrast 16,000:1
Light Source Life 6,000/12,000 hrs	Keystone ±30° (V) / ±30° (H)	Connectivity USB Type-B x 1, VGA x 1, HDMI x 1
Network Optional [ELPAP11]	Power Consumption 327W / 225W	Weight 2.5 kg



12,000 Hours
Lamp Life in Eco Mode



Split Screen



Auto Vertical
Keystone



Horizontal
Keystone Adjuster



Wireless
iProjection

3LCD PROJECTOR

EB-E10



Brightness 3,600 lm	Resolution XGA	Contrast 15,000:1
Light Source Life 6,000/12,000 hrs	Keystone $\pm 30^\circ$ [V] / $\pm 30^\circ$ [H]	Connectivity USB Type-B x 1, VGA x 1, HDMI x 1
Network N/A	Power Consumption 327W / 225W	Weight 2.4 kg



12,000 Hours
Lamp Life in Eco Mode



Split Screen

EB-E500



Brightness 3,300 lm	Resolution XGA	Contrast 15,000:1
Light Source Life 6,000/12,000 hrs	Keystone $\pm 30^\circ$ [V] / $\pm 30^\circ$ [H]	Connectivity USB Type-B x 1, VGA x 1, HDMI x 1
Network N/A	Power Consumption 327W / 225W	Weight 2.4 kg



12,000 Hours
Lamp Life in Eco Mode



Split Screen

3LCD PROJECTOR

Small Sized Rooms

EB-X500



Brightness 3,600 lm	Resolution XGA	Contrast 16,000:1
Light Source Life 6,000/12,000 hrs	Keystone ±30° (V) / ±30° (H)	Connectivity USB Type-A & Bx1 VGA x1, HDMI x1,
Network Optional (ELPAP11)	Power Consumption 327W / 225W	Weight 2.5 kg



12,000 Hours
Lamp Life in Eco Mode



Split Screen



Auto Vertical
Keystone



Horizontal Keystone
Adjuster*



Wireless
iProjection

EB-X51



Brightness 3,800 lm	Resolution XGA	Contrast 16,000:1
Light Source Life 6,000/12,000 hrs	Keystone ±30° (V) / ±30° (H)	Connectivity HDMI in x1, VGA in x1 RCA x1, 2RCA x1 USB Type-A & Bx1
Network Optional (ELPAP11)	Power Consumption 327W / 225W	Weight 2.5 kg



12,000 Hours
Lamp Life in Eco Mode



Split Screen



Auto Vertical
Keystone



Horizontal Keystone
Adjuster*



Wireless
iProjection

3LCD PROJECTOR

EB-W51



Brightness 4,000 lm	Resolution WXGA	Contrast 16,000:1
Light Source Life 6,000/12,000 hrs	Keystone ±30° [V] / ±30° [H]	Connectivity HDMI in x1, VGA in x1 RCA x1, 2RCA x1 USB Type-A & Bx1
Network Optional (ELPAP11)	Power Consumption 327W / 225W	Weight 2.5 kg



12,000 Hours
Lamp Life in Eco Mode



Split Screen



Auto Vertical
Keystone



Horizontal Keystone
Adjuster*



Wireless
iProjection

EB-FH52



Brightness 4,000 lm	Resolution 1080p	Contrast 16,000:1
Light Source Life 5,500/12,000 hrs	Keystone ±30° [V] / ±30° [H]	Connectivity HDMI in x2, VGA in x1 RCA x1, 2RCA x1 USB Type-A & Bx1
Network Built-in Support Screen Mirroring	Power Consumption 327W / 225W	Weight 3.1 kg



12,000 Hours
Lamp Life in Eco Mode



Split Screen



Auto Vertical
Keystone



Horizontal Keystone
Slider



Wireless iProjection
/ Screen Mirroring



Full HD
Resolution

3LCD PROJECTOR

Small Sized Rooms

EB-972



Brightness 4,100 lm	Resolution XGA	Contrast 16,000:1
Light Source Life 6,500/17,000 hrs	Keystone $\pm 30^\circ$ (V) / $\pm 30^\circ$ (H)	Connectivity HDMI in x2, VGA in x1, VGA out x1, RCA in x1, 2RCA x1 Stereo Mini Jack in x2 Stereo Mini Jack out x1 USB Type-A & Bx1
Network Optional (ELPAP11)	Power Consumption 327W / 225W	Weight 3.1 kg



17,000 Hours
Lamp Life in Eco Mode



Split Screen



Auto Vertical
Keystone



Horizontal Keystone
Slider



Wireless
iProjection

EB-982W



Brightness 4,200 lm	Resolution WXGA	Contrast 16,000:1
Light Source Life 6,500/17,000 hrs	Keystone $\pm 30^\circ$ (V) / $\pm 30^\circ$ (H)	Connectivity HDMI in x2, VGA in x1, VGA out x1, RCA in x1, 2RCA x1 Stereo Mini Jack in x2 Stereo Mini Jack out x1 USB Type-A & Bx1
Network Optional (ELPAP11)	Power Consumption 327W / 225W	Weight 3.1 kg



17,000 Hours
Lamp Life in Eco Mode



Split Screen

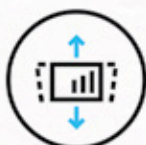

Auto Vertical
Keystone



Horizontal Keystone
Slider



Wireless
iProjection

3LCD PROJECTOR

Ultra Portable Projectors

EB-1785W Gesture Presenter



Brightness 3,200lm	Resolution WXGA	Contrast 10,000:1
Light Source Life 4,000 / 7,000 hrs	Keystone $\pm 45^\circ$ (V) / $\pm 30^\circ$ (H)	Connectivity VGA in x1, HDMI in x1 [Support MHL] Stereo Mini Jack in x1 USB Type-A & Bx1
Network Built-in Support Screen Mirroring	Power Consumption 295W / 208W	Weight 1.81 kg



Gesture
Presenter



NFC



Wireless
Projection



Real-Time Auto V/H
Keystone Correction



Split Screen



reddot design award

EB-1795F Gesture Presenter



Brightness 3,200lm	Resolution 1080p	Contrast 10,000:1
Light Source Life 4,000 / 7,000 hrs	Keystone $\pm 45^\circ$ (V) / $\pm 30^\circ$ (H)	Connectivity HDMI in x1 [Support MHL] VGA in x1, RCA x1 Stereo Mini Jack in x1 USB Type-A & Bx1
Network Built-in Support Screen Mirroring	Power Consumption 295W / 208W	Weight 1.83 kg



Gesture
Presenter



NFC



Wireless
Projection



Real-Time Auto V/H
Keystone Correction



Split Screen



Full HD

3LCD PROJECTOR

Mid Size Rooms Projectors

3LCD PROJECTOR

EB-2265U Gesture Presenter



Brightness 5,500lm	Resolution WUXGA	Contrast 15,000:1
Light Source Life 5,000 / 10,000 hrs	Keystone $\pm 30^\circ(V) / \pm 30^\circ(H)$	Connectivity HDBaset x1, HDMI in x2 (1 Support MHL) VGA in x2, VGA out x1 Stereo Mini Jack in x2 Stereo Mini Jack out x1 2RCA x1, RCA x1, RS-232C x1, RJ45 x1 USB Type-A & Bx1
Network Optional [ELPAP10]	Power Consumption 425W / 323W	Weight 4.7 kg



Gesture
Presenter



Multi-PC
Projection



Wireless
Projection



Split Screen

EB-2155W



Brightness 5,000lm	Resolution WXGA	Contrast 15,000:1
Light Source Life 5,000 / 10,000 hrs	Keystone $\pm 30^\circ(V) / \pm 30^\circ(H)$	Connectivity HDMI in x2 (1 Support MHL) VGA in x2, VGA out x1 Stereo Mini Jack in x2 Stereo Mini Jack out x1 2RCA x1, RCA x1, RS-232C x1, RJ45 x1 USB Type-A & Bx1
Network Optional [ELPAP10]	Power Consumption 405W / 323W	Weight 4.3 kg



Gesture
Presenter



Multi-PC
Projection



Wireless
Projection



Split Screen

3LCD PROJECTOR



EB-L630U/EB-L730U



Wireless Projection



Flexible 360 degree installation



WUXGA Resolution



Edge Blending Technology

EB-L630U

Brightness 6,200 lm	Resolution WUXGA (16:10)	Contrast over 2,500,000 : 1
Light Source Life 20,000 hours	Keystone ±30°(V) / ±30°(H)	Connectivity D-Sub 15Pin IN x 2, HDMI In x 2, HDBaseT RJ45 In x 1, D-Sub 15Pin Out x 1, Stereo Mini Jack In x 2, Stereo Mini Jack Out x 1, USB Type A x 1, USB Type B x 1, RS-232C D-Sub 15Pin x 1, Wired Lan RJ45 x 1, HDMI Out x1
Network Built-In	Power Consumption 345W / 258W	Weight Approx 8.4 Kg

EB-L730U

Brightness 7,000 lm	Resolution WUXGA (16:10)	Contrast over 2,500,000 : 1
Light Source Life 20,000 hours	Keystone ±30°(V) / ±30°(H)	Connectivity D-Sub 15Pin IN x 2, HDMI In x 2, HDBaseT RJ45 In x 1, D-Sub 15Pin Out x 1, Stereo Mini Jack In x 2, Stereo Mini Jack Out x 1, USB Type A x 1, USB Type B x 1, RS-232C D-Sub 15Pin x 1, Wired Lan RJ45 x 1, HDMI Out x1
Network Built-In	Power Consumption 345W / 258W	Weight Approx 8.4 Kg

3LCD PROJECTOR

Mid Size Rooms Projectors

3LCD PROJECTOR



EB-L570U/EB-L770U



Wireless Projection



Flexible 360 degree installation



Edge Blending Technology

EB-L570U

Brightness 6,200 lm	Resolution WUXGA [4K Enhancement]	Contrast over 2,500,000 : 1
Light Source Life 20,000 hours	Keystone $\pm 30^\circ[V] / \pm 30^\circ[H]$	Connectivity HDMI In x 2, HDBaseT RJ45 In x 1, D-Sub 15Pin Out x 1, Stereo Mini Jack In x 2, Stereo Mini Jack Out x 1, USB Type A x 1, USB Type B x 1, RS-232C D-Sub 15Pin x 1, Wired Lan RJ45 x 1, HDMI Out x1
Network Optional [ELPAP11]	Power Consumption 312W/234W	Weight Approx 8.4 Kg

EB-L770U

Brightness 7,000 lm	Resolution WUXGA [16:10]	Contrast over 2,500,000 : 1
Light Source Life 20,000 hours	Keystone $\pm 30^\circ[V] / \pm 30^\circ[H]$	Connectivity D-Sub 15Pin IN x 2, HDMI In x 2, HDBaseT RJ45 In x 1, D-Sub 15Pin Out x 1, Stereo Mini Jack In x 2, Stereo Mini Jack Out x 1, USB Type A x 1, USB Type B x 1, RS-232C D-Sub 15Pin x 1, Wired Lan RJ45 x 1, HDMI Out x1
Network Built-In	Power Consumption 366W/268W	Weight Approx 8.4 Kg

EPSON

ULTRA VERSATILE

Shine bright with Epson Business and Education Projectors

The Epson Projectors for Business and Education are designed to offer full flexibility and whole new possibilities. Whether you're delivering life-changing lessons or deal-clinching presentations, the big screen experience will make sure you get the impact you need. There are options to fit a wide range of space sizes and layouts, with high lumens, projected content remains brilliant even in well-lit environments.

Explore the full Epson Business and Education Projector range at epson.com.sg/corporate-education



IT'S IN THE DETAILS.

Laser Light Source is applicable to selected models only.

3LCD PROJECTOR

Ultra Portable Projectors

EB-2065



Brightness 5,500lm	Resolution XGA	Contrast 15,000:1
Light Source Life 5,000 / 10,000 hrs	Keystone ±30°[V] / ±30°[H]	Connectivity HDMI in x2 (1 Support MHL) VGA in x2, VGA out x1 2RCA x1, RCA x1, RS-232C x1, RJ45 x1 Stereo Mini Jack in x2 Stereo Mini Jack out x1 USB Type-A & Bx1
Network Optional (ELPAP10)	Power Consumption 425W / 323W	Weight 4.4 kg



Gesture
Presenter



Multi-PC
Projection



Wireless
Projection



Split Screen

EB-L520U



Brightness 5,200lm	Resolution WUXGA (1920 x 1200)	Contrast over 2,500,000 : 1
Light Source Life 20,000 hours	Keystone ±30°[V] / ±30°[H]	Connectivity D-Sub 15Pin IN x 2, HDMI In x 2, HDbaseT RJ45 In x 1, D-Sub 15Pin Out x 1, Stereo Mini Jack In x 2, Stereo Mini Jack Out x 1, USB Type A x 1, USB Type B x 1, RS-232C D-Sub 9Pin x 1, Wired Lan RJ45 x 1,
Network Optional (ELPAP11)	Power Consumption 293W/233W	Weight Approx 7.7 Kg



Split Screen



Flexible
360 degree
installation

3LCD PROJECTOR

Business Projector

EB-L210W



Brightness 4,500lm / 3,100lm	Resolution WXGA (1280 x 800)	Contrast Over 2,500,000 : 1
Light Source Life 20,000 / 30,000 hrs	Keystone $\pm 30^\circ$ [V] / $\pm 30^\circ$ [H]	Connectivity <ul style="list-style-type: none">-HDMI 2 (HDCP 2.3)-D-Sub 15Pin (1 [Black] lin common with Computer 2)-RCA 2 (White, Red)-Stereo Mini Jack (2)-USB Type A & B
Network <ul style="list-style-type: none">-Wired LAN : RJ45 x 1 (100Mbps)-Wireless : Built-in*2 and Optional (Using ELPAP11)	Power Consumption <ul style="list-style-type: none">-Lamp On [Normal / Extended] : 260W / 191W- Standby [Network On / Off] : 2.0W / 0.5W	Weight Approx. 4.2kg



30,000 Hours
Lamp Life in Eco Mode



Split Screen

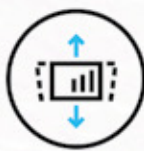

Auto Vertical
Keystone



Horizontal
Keystone Adjuster



Wi-Fi
Connection



EB-L260F



Brightness 4,600lm / 3,200lm	Resolution Full HD (1080p)	Contrast Over 2,500,000 : 1
Light Source Life 20,000 / 30,000 hrs	Keystone $\pm 30^\circ$ [V] / $\pm 30^\circ$ [H]	Connectivity <ul style="list-style-type: none">-HDMI 2 (HDCP 2.3)-D-Sub 15Pin (1 [Black] lin common with Computer 2)-RCA 2 (White, Red)-Stereo Mini Jack (2)-USB Type A & B
Network <ul style="list-style-type: none">-Wired LAN : RJ45 x 1 (100Mbps)-Wireless : Built-in*2 and Optional (Using ELPAP11)	Power Consumption <ul style="list-style-type: none">-Lamp On [Normal / Extended] : 260W / 191W- Standby [Network On / Off] : 2.0W / 0.5W	Weight Approx. 4.2kg



30,000 Hours
Lamp Life in Eco Mode



Split Screen



Auto Vertical
Keystone



Horizontal
Keystone Adjuster



Wi-Fi
Connection



3LCD PROJECTOR

Short Throw Projectors



EB-L210SW

Brightness 4,000lm / 2,800lm	Resolution WXGA (1280 x 800)	Contrast over 2,500,000 : 1
Light Source Life Type : Laser Diode Life [Normal / Quiet / Extended] : 20,000 / 20,000 / 30,000 hrs	Keystone ±15°(V) / ±15°(H)	Connectivity HDMI 2 (HDCP 2.3) D Sub 15 Pin RCA Stereo Mini Jack USB Type A & B
Network Wired LAN : RJ45 x 1 (100Mbps) Wireless : Built-in*2 and Optional wireless (using ELPAP11)	Power Consumption Lamp On [Normal / Extended] 260W / 191W Standby [Network On / Off] 2.0W / 0.5W	Weight Approx 4.6 Kg



Short Throw



30,000
Light Hours



Wi-Fi
Connection



Multi-PC
Projection



EB-L210SF

Brightness 4,000lm / 2,800lm	Resolution Full HD (1080p)	Contrast over 2,500,000 : 1
Light Source Life Type : Laser Diode Life [Normal / Quiet / Extended] : 20,000 / 20,000 / 30,000 hrs	Keystone ±15°(V) / ±15°(H)	Connectivity HDMI 2 (HDCP 2.3) D Sub 15 Pin RCA Stereo Mini Jack USB Type A & B
Network Wired LAN : RJ45 x 1 (100Mbps) Wireless : Built-in*2 and Optional wireless (using ELPAP11)	Power Consumption Lamp On [Normal / Extended] 260W / 191W Standby [Network On / Off] 2.0W / 0.5W	Weight Approx 4.6 Kg



Short Throw



30,000
Light Hours



Wi-Fi
Connection



Multi-PC
Projection

3LCD PROJECTOR

EB-L630SU



Brightness 6,000 lm	Resolution WUXGA (16:10)	Contrast over 2,500,000 : 1
Light Source Life 20,000 hours	Keystone $\pm 30^\circ$ [V] / $\pm 30^\circ$ [H]	Connectivity D-Sub 15Pin IN x 2, HDMI In x 2, HDbaseT RJ45 In x 1, D-Sub 15Pin Out x 1, Stereo Mini Jack In x 2, Stereo Mini Jack Out x 1, USB Type A x 1, USB Type B x 1, RS-232C D-Sub 15Pin x 1, Wired Lan RJ45 x 1, HDMI Out x1
Network Built-In	Power Consumption 345W / 258W	Weight Approx 8.4 Kg



Wireless Projection

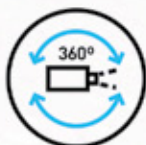

Flexible 360 degree installation



WUXGA Resolution



Edge Blending Technology



Lightning Scene

EB-W50



Brightness 3,800 lm	Resolution WXGA (1280 x 800)	Contrast 16,000:1
Light Source Life 10,000 hours [Normal], 17,000 hours [Eco]	Keystone $\pm 30^\circ$ [V] / $\pm 30^\circ$ [H]	Connectivity D-Sub 15 Pin In x 2, HDMI In x 2, D-Sub 15Pin Out x 1, Stereo Mini Jack In x 2, Stereo Mini Jack Out x 1, USB Type A x 1, USB Type B x 1, RS-232C D-Sub 9pin x 1, Wired LAN RJ45 x 1
Network Wireless ELPAP10 (Optional)	Power Consumption 285 W / 218 W	Weight 3.1 kg



17,000 Hours Lamp Life in Eco Mode



Split Screen



Auto Vertical Keystone



Dust Resistance Design



USB Direct Playback

3LCD PROJECTOR

Lighting Scene



EB-U50

Brightness 3,700 lm	Resolution WUXGA	Contrast 16,000:1
Light Source Life 10,000/17,000 hrs	Keystone ±30° (V) / ±30° (H)	Connectivity HDMI in x2, VGA in x2 VGA out x1, RJ45 x1 Stereo Mini Jack in x2 Stereo Mini Jack out x1 USB Type-A & Bx1
Network Built-in	Power Consumption 285W / 218W	Weight 3.1 kg



17,000 Hours
Lamp Life in Eco Mode



Split Screen



Auto Vertical
Keystone



Dust Resistance
Design



USB Direct
Playback

EV-110/EV-115



EV-110 (White)

EV-115 (Black)

Brightness 2,200lm	Resolution WXGA	Contrast >2,500,000:1
Laser Light Source 20,000 hrs	Keystone ±45°(V) / ±40°(H)	Connectivity HDMI in x1 SD Card x1, RJ45 x1 Stereo Mini Jack out x1 USB Type-A & Bx1
Network Built-in	Power Consumption 149W / 112W	Weight 6.9 kg (Exclude Direct Mount)

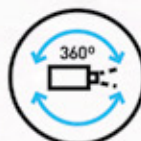

Flexible
Installation



Sleek Spotlight
Design

3LCD PROJECTOR



EB-800F / 805F

Brightness 5,000 lm	Resolution 1080p	Contrast over 2,500,000 : 1
Light Source Life 20,000 hours (Normal), 30,000 hours (Extended)	Keystone ±3° [V] / ±3° [H]	Connectivity D-Sub 15Pin In x 2, Composite In RCA x 1 (Yellow), HDMI In x 3 (HDCP2.3), HDBaseT x 1 (HDCP2.3), D-Sub 15Pin Out x 1, HDMI Out x 1, Stereo Mini Jack In x 3, Stereo Mini Jack Out x 1, RS-232C D-Sub 9Pin x 1, USB Type A x 2, USB Type B x 1, Wired Lan RJ45 x 1
Network Wireless Lan x 1 USB Type A	Power Consumption 366 W / 262 W	Weight Approx 9.4 Kg



Full HD Resolution



Ultra short-throw
130 inch @80,3 cm



Multi-PC Projection



PC free
USB memory

Ultra Short Throw Lamp Projectors

EB-685W



Brightness 3,500 lm	Resolution WXGA	Contrast 14,000:1
Light Source Life 5,000/10,000 hrs	Keystone ±3° [V] / ±3° [H]	Connectivity HDMI in x3, RCA x1 VGA in x2, VGA out x1 RS-232C x1, RJ45 x1 Stereo Mini Jack out x1 Stereo Mini Jack in x3 USB Type-A & Bx1 Microphone x1
Network Optional (ELPAP10)	Power Consumption 354W / 309W	Weight 5.7 kg



Ultra-Short
Throw



10,000 Hours
Lamp Life in Eco Mode



Multi-PC
Projection

3LCD PROJECTOR

Ultra Short Throw Lamp Projectors



NEW
PRODUCT

EB-760W

Brightness 4,100lm / 2,800lm	Resolution WXGA (1280 x 800)	Contrast over 2,500,000 : 1
Light Source Life Type : Laser Diode Life (Normal / Quiet / Extended) : 20,000 / 20,000 / 30,000 hrs	Keystone $\pm 3^\circ$ (V) / $\pm 3^\circ$ (H)	Connectivity HDMI Stereo Mini Jack USB Type A & B
Network Wired LAN RJ45 x 1 (100Mbps) Wireless Built-in and Optional (using ELPAP11)	Power Consumption Lamp On (Normal / Extended) 263W / 199W Standby (Network On / Off) 2.0W / 0.5W	Weight Approx 5.9 Kg



Ultra-Short
Throw



20,000 Light
Hours



Wireless
Connection



Multi-PC
Projection

EB-770F



NEW
PRODUCT

Brightness 4,100lm / 2,800lm	Resolution Full HD (1080p)	Contrast over 2,500,000 : 1
Light Source Life Type : Laser Diode Life (Normal / Quiet / Extended) : 20,000 / 20,000 / 30,000 hrs	Keystone $\pm 3^\circ$ (V) / $\pm 3^\circ$ (H)	Connectivity HDMI Stereo Mini Jack USB Type A & B
Network Wired LAN RJ45 x 1 (100Mbps) Wireless Built-in and Optional (using ELPAP11)	Power Consumption Lamp On (Normal / Extended) 263W / 199W Standby (Network On / Off) 2.0W / 0.5W	Weight Approx 5.9 Kg



Ultra-Short
Throw



20,000 Light
Hours



Wireless
Connection



Multi-PC
Projection



Full HD

3LCD PROJECTOR

EB-760Wi



NEW
PRODUCT

Brightness 4,100lm / 2,800lm	Resolution WXGA (1280 x 800)	Contrast over 2,500,000 : 1
Light Source Life Type : Laser Diode Life (Normal / Quiet / Extended) : 20,000 / 20,000 / 30,000 hrs	Keystone ±3°(V) / ±3°(H)	Connectivity HDMI Stereo Mini Jack USB Type A & B
Network Wired LAN RJ45 x 1 (100Mbps) Wireless Built-in and Optional (using ELPAP11)	Power Consumption Lamp On (Normal / Extended) 263W / 199W Standby (Network On / Off) 2.0W / 0.5W	Weight Approx 6.0 Kg



Ultra-Short
Throw



20,000 Light
Hours



Wireless
Connection



Multi-PC
Projection



Optional Finger
Touch Interactive

EB-770Fi



NEW
PRODUCT

Brightness 4,100lm / 2,800lm	Resolution Full HD (1080p)	Contrast over 2,500,000 : 1
Light Source Life Type : Laser Diode Life (Normal / Quiet / Extended) : 20,000 / 20,000 / 30,000 hrs	Keystone ±3°(V) / ±3°(H)	Connectivity HDMI Stereo Mini Jack USB Type A & B
Network Wired LAN RJ45 x 1 (100Mbps) Wireless Built-in and Optional (using ELPAP11)	Power Consumption Lamp On (Normal / Extended) 263W / 199W Standby (Network On / Off) 2.0W / 0.5W	Weight Approx 6.0 Kg



Ultra-Short
Throw



20,000 Light
Hours



Wireless
Connection



Multi-PC
Projection



Full HD



Finger Touch
Interactive

3LCD PROJECTOR

Ultra Short Throw Lamp Projectors

EB-695Wi Touch Interactive



Brightness 3,500 lm	Resolution WXGA	Contrast 14,000:1
Light Source Life 5,000/10,000 hrs	Keystone ±3° (V) / ±3° (H)	Connectivity HDMI in x3, RCA x1 VGA in x2, VGA out x1 RS-232C x1, RJ45 x1 Stereo Mini Jack out x1 Stereo Mini Jack in x3 Interactive Sync x1 USB Type-A & Bx1 Microphone x1
Network Optional (ELPAP10)	Power Consumption 354W / 309W	Weight 5.8 kg



Ultra-Short
Throw



10,000 Hours
Lamp Life in Eco Mode



Finger Touch
Interactive



Multi-PC
Projection

EB-1485Fi Touch Interactive



Brightness 5,000lm	Resolution 1080p	Contrast >2,500,000:1
Laser Light Source 20,000 hrs	Keystone ±3°(V) / ±3°(H)	Connectivity HDMI in x3 (HDCP2.3) HDBaseT x1 (HDCP2.3) HDMI out x1, RJ45 x1 VGA in x2, VGA out x1 Stereo Mini Jack in x3 Stereo Mini Jack out x1 RCA x1, RS-232C x1 Interactive Sync x1 Microphone x1, USB Type-A & Bx1
Network Built-in Support Screen Mirroring	Power Consumption 366W / 262W	Weight 9.3 kg



Ultra-Short
Throw



20,000 Light
Hours



Wireless
Connection



Multi-PC
Projection



Finger Touch
Interactive



Full HD

3LCD PROJECTOR

Large Venues

EB-PU1006W/ EB-PU1007W



Brightness 6.000 lm (PU1006W) 7.000 lm (PU1007W)	Resolution WUXGA	Contrast >2,500,000:1
Laser Source Life 20,000 hrs	Keystone ±45°[V] / ±30°[H]	Connectivity D-Sub 15Pin in x1, HDMI in x1, DVI-D in x1, HDBaseT, USB Type A x2 USB Type B x1, RS-232C x1, Stereo Mini Out x1, RJ45
Network Wireless Optional (ELPAP11)	Power Consumption 367W (PU1006W) 431W (PU1007W)	Weight 15.4 kg (PU1006W) 16.3 kg (PU1007W)



HDBaseT



Edge
Blending



Flexible
Installation



NFC

EB-PU1008B/ EB-PU2010B



Brightness 8,500 lm (PU1008B) 10,000 lm (PU2010B)	Resolution WUXGA	Contrast >2,500,000:1
Laser Source Life 20,000 hrs	Keystone ±45°[V] / ±30°[H]	Connectivity D-Sub 15Pin in x1, HDMI in x1, DVI-D in x1, HDBaseT, USB Type A x2 USB Type B x1, RS-232C x1, Stereo Mini Out x1, RJ45, SDI x1 (for PU2010B)
Network Wireless Optional (ELPAP11)	Power Consumption 535W	Weight 16.3 kg (PU1008B) 16.8 kg (PU2010B)



HDBaseT



Edge
Blending



Flexible
Installation



NFC

3LCD PROJECTOR

Large Venues



EB-PU2213B

Brightness 13,000lm	Resolution WUXGA	Contrast >2,500,000:1
Laser Source Life 20,000 hrs	Keystone ±45°(V) / ±30°(H)	Connectivity HDMI in x1, SDI x1 HDBaseT x1 VGA in x1, VGA out x1 5BNC x1, DVI-D x1 RS-232C x1, RJ45 x1 Stereo Mini Jack in x3 Stereo Mini Jack out x1 USB Type-A & Bx1
Network Wireless optional (ELPAP10)	Power Consumption 908W / 597W	Weight 21.9 kg

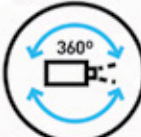

HDBaseT

Flexible Installation

Edge Blending

EB-PU2216B



Brightness 16,000lm	Resolution WUXGA	Contrast >2,500,000:1
Laser Source Life 20,000 hrs	Keystone ±45°(V) / ±30°(H)	Connectivity HDMI in x1 HDBaseT x1 VGA in x1, VGA out x1 5BNC x1, DVI-D x1 RS-232C x1, RJ45 x1 Stereo Mini Jack in x3 Stereo Mini Jack out x1 USB Type-A & Bx1
Network Wireless optional (ELPAP10)	Power Consumption 1024W / 647W	Weight 22.3 kg



HDBaseT

Edge Blending

Flexible Installation

3LCD PROJECTOR

EB-PU2220B



Brightness 20,000lm	Resolution WUXGA	Contrast >2,500,000:1
Laser Source Life 20,000 hrs	Keystone $\pm 44^\circ(V) / \pm 30^\circ(H)$	Connectivity HDBaseT x1, RS-232C x1 VGA in x1, VGA out x1 BNC in x1, SDI in x1 Expansion Board ELPIF01 (HDMI in x1, DVI-D x1, DC-Out x1) Expansion Board ELPIF03 (Display port in x2) BNC out x1 RJ-45 x1 (etherCON) USB Type-A & B x1
Network Built-in	Power Consumption 1860W / 1123W	Weight 49.6 kg

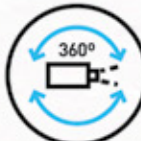

HDBaseT

Flexible
Installation

Edge
Blending

EB-L30000UNL



Brightness 30,000lm	Resolution WUXGA	Contrast >2,500,000:1
Laser Source Life 20,000 hrs	Keystone $\pm 45^\circ(V) / \pm 30^\circ(H)$	Connectivity HDBaseT x1 (HDCP 2.2) VGA in x1, VGA out x1 SDI in x1, 5BNC x1 DVI-D x1 (Single link, HDCP 1.4) HDMI in x1 (HDCP 2.2) SDI out x1, RS-232C x1 Remote x1, RJ45 x1 USB Type-A & B x1
Network Optional	Power Consumption 2325W / 1511W	Weight 69.9 kg

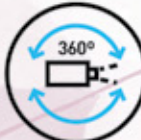

HDBaseT

Flexible
Installation

Edge
Blending

3LCD PROJECTOR

Home Entertainment Projectors



EpiqVision EF-11

Brightness 1,000lm	Resolution Full HD (1080p)	Contrast > 2,500,000:1
Weight Approx 1.2 kg	Keystone ±34° (V) / ±40° (H)	Connectivity HDMI x1 (HDCP 1.4) Stereo Mini Jack Out x1 USB Type-A & Type-B x1



Auto Vertical Keystone



Miracast

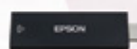

Android TV™ Dongle (ELPAP12)
sudah ada di dalam unit nya



EpiqVision EF-12

Brightness 1,000lm	Resolution Full HD (1080p)	Contrast > 2,500,000:1
Weight Approx 2.1 kg	Keystone ±34° (V) / ±40° (H)	Connectivity HDMI x1 (HDCP 1.4) Stereo Mini Jack Out x1 USB Type-A & Type-B x1



AndroidTV



Miracast

sound by YAMAHA

3LCD PROJECTOR

EH-TW6250



NEW
PRODUCT

Brightness 2,800lm / 1,900lm	Resolution Full HD (1080P)	Contrast 35,000 : 1
Light Source Life Type Lamp: 200W UHE Lamp Life*1 Normal: 4,500 / Eco: 7,500 hours	Keystone ±30°(V) / ±30°(H)	Connectivity HDMI USB Type B
Network -	Power Consumption Lamp On (Normal / Quiet, Extended) 301W / 231W Energy Saving 0.3W	Weight Approx 4.1 Kg

4K PRO-UHD



Auto Vertical Keystone



AndroidTV

EH-LS800B



NEW
PRODUCT

Brightness 4,000lm / 2,000lm	Resolution 4K	Contrast Over 2,500,000:1
Light Source Life 20,000 hours (Normal / Eco)	Keystone -	Connectivity HDMI USB Type A
Network -	Power Consumption Lamp On (Normal / Quiet, Extended) 335W / 210W Standby (Network On / Off) 2.0W / 0.4 W	Weight Approx 7.2 Kg



AndroidTV

sound by **YAMAHA**

Chromecast built-in

3LCD PROJECTOR

Home Entertainment

EpiqVision Ultra EH-LS300B

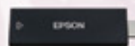

Android TV™ Dongle (ELPAP12)
sudah ada di dalam unit nya



Brightness 3,600lm	Resolution Full HD (1080p)	Contrast > 2,500,000:1
Laser Light Source 20,000 hrs	Keystone 8 point arc correction	Connectivity HDMI x2 (SMF, HDMI2=ARC) Audio Out (Bluetooth & Optical Out) USB Type-A x 1 USB Type-B Mini x1
Wireless Built-in	Power Consumption 278 W	Weight & Dimension Approx. 7.2 kg 400x467x133 mm



sound by **YAMAHA**

Chromecast built-in

EH-LS12000B



Brightness 2,700lm	Resolution 4K	Contrast > 2,500,000:1
Laser Light Source 20,000 hrs	Keystone ±30° (V) / ±30° (H)	Connectivity HDMI x 2 USB Type-A x 2 USB Type-B x 1 Stereo Mini Jack Out x 1
Network N/A	Power Consumption 302W/198W	Dimension Approx. 12.7kg 447 x 520 x 169 mm



4K



Lens Shift

3LCD PROJECTOR

EH-TW7000



Brightness 3,000lm	Resolution Full HD (1080p)	Contrast 40,000:1
Light Source Life 3,500 hrs / 5,000 hrs	Keystone ±30° (V) / ±30° (H)	Connectivity HDMI x 2 (HDCP 2.2) Stereo Mini Jack Out x 1 USB Type-A x 2 Type-B Mini x 1 Wireless ELPAP10 (Optional)
Max Screen Size 500 inch	Power Consumption 368W/280W	Weight & Dimension Approx 6.6 kg 410 x 310 x 157 mm

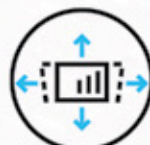

Vertical & Horizontal
Keystone Adjuster

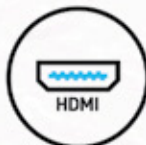

HDMI



EH-TW9400



Brightness 2,600lm	Resolution Full HD (1080p)	Contrast 1,200,000:1
Light Source Life 3,500 hrs / 5,000 hrs	Keystone ±30° (V)	Connectivity HDMI x 2 (HDCP 2.2) Stereo Mini Jack Out x 1 USB Type-A x 2 Type-B Mini x 1 Wireless ELPAP10 (Optional)
Max Screen Size 300 inch	Power Consumption 355W / 271W	Weight & Dimension Approx. 11.2 kg 520 x 170 x 450 mm

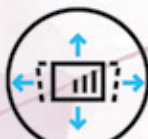

Lens Shift

3LCD PROJECTOR

Cross Over

3LCD PROJECTOR



CO-FH01

Brightness 3,000lm / 2,000lm	Resolution Full HD (1080P)	Contrast -
Light Source Life -	Keystone $\pm 30^\circ$ (V) / $\pm 30^\circ$ (H)	Connectivity HDMI USB Type A & B
Network Wireless (Optional)	Power Consumption 270W / 214W	Weight Approx 2.4 Kg

Full HD
1080p

CO-FH02



Brightness 3,000lm / 2,000lm	Resolution Full HD (1080P)	Contrast -
Light Source Life Type Lamp (Fixed), 188 W UHE Life (Normal/ Extended) 6,000 / 12,000 hours (Normal / ECO)	Keystone $\pm 30^\circ$ (V) / $\pm 30^\circ$ (H)	Connectivity USB Type A & B
Network -	Power Consumption 270W / 214W	Weight Approx 2.6 Kg

Full HD
1080p



Chromecast built-in

3LCD PROJECTOR

Wireless Presenter



ELPWP10

Ideal for small-group presentation, Selected Epson projectors offers an affordable and versatile wireless presentation system for offices.

[Contents: Wireless Dongle x2, ELPAP11 x1, Tray x1]



ELPWP20

- Cable-free collaboration Wireless presentation system for maximum ease of use
- Instant multi-screen sharing Display up to four devices simultaneously
- Display-agnostic Compatible with all displays with a HDMI input
- Compatibility with all major OSs Works with Windows, Mac, Android, iOS and Chromebooks
- Miracast built in For simple sharing on compatible devices

[Contents: Wireless Dongle x2, Base Station x1, Tray x1, IR Remote x1]



ELPWT01

- Power Consumption 5 VDC / 0.5 A
- Operating Temperature 0 to +40°C (Humidity of 20 to 80%, No condensation)
- Storage Temperature -20 to +70°C (Humidity of 0 to 95%, No condensation)
- Operating Altitude 0 to 3,000 m
- Dimensions Width 63.5 x Height 11 x Depth 175 mm (excluding USB conversion adapter)
- Weight Approx. 53 g

[Contents: Wireless Dongle x1]

TM PRINTER



TM PRINTER

TM-M30II

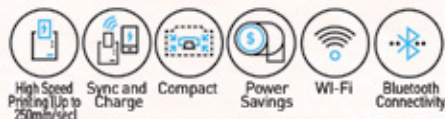
**NEW
PRODUCT**

Print Method	Thermal Line Printing
Print Speed	250 mm/sec
Interface	USB + Ethernet/ USB + Ethernet + Bluetooth/ 3.0 EDR
Paper Dimension	Roll Paper: 57.5 ± 0.5 (w) x Ø 40.4 mm
Operating System	Mobile IOS, Android and Windows, (security LEVELWEP, WPA, WPA2-Personal/Enterprise)
Power Consumption	32.4 W
Overall Dimension	127 x 127 x 135 mm
Weight	1.3 Kg

EU-M30



Print Method	Thermal Line Printing
Print Speed	250 mm/sec
Interface	USB 2.0 Type B, RS-232C
Paper Size	58 mm - 80 mm (Width)
Paper size roll paper	57.50 ± 0.50 (W) mm x dia 18.00 mm, 57.50 ± 0.50 (W) mm x dia 83.00 mm, 79.50 ± 0.50 (W) mm x dia 18.00 mm, 79.50 ± 0.50 (W) mm x dia 83.00 mm
Operating System	Mobile IOS, Android and Windows, (security LEVELWEP, WPA, WPA2-Personal/Enterprise)
Power Supply	AC adapter, C, EURO AC cable
Overall Dimension	127 x 131 x 127 mm
Weight	1.3 kg



TM PRINTER

Mobile (Portable) Receipt Printer

TM-P20II Mobile



Mobility



Print



Power Savings



Print Method
Print Speed
Character Size

Thermal Line Printing
100 mm/sec (Receipt Version)
font A: 1.5 x 3.0 mm;
font B: 1.12 x 3.0 mm;
font C: 1.12 x 2.1 mm;
font D: 1.25 x 3.0 mm;
font E: 1.0 x 2.0 mm

Paper Dimension
Operating System

Roll Paper: 57.5 ± 0.5 (w) x Ø 40.4 mm
Mobile iOS, Android and Windows, (security LEVELWEP, WPA, WPA2-Personal/Enterprise

Power Consumption

Wi-Fi: 9 hours (energy saving mode): 16 hours |
Bluetooth: 26 hours

Overall Dimension
Option

79.0 x 119.8 x 43.6 mm
Single Printer Charger/Cradle (OT-SC20),
Battery Pack (OT-BY20), Padded Case (OT-PC20),
Battery Spacer (OT-BS20)

TM-P80II



Mobility



Print



Power Savings



Print Method
Print Speed
Character Size

Thermal Line Printing
100 mm/sec (Receipt Version)
font A: 1.5 x 3.0 mm;
font B: 1.12 x 3.0 mm;
font C: 1.12 x 2.1 mm;
font D: 1.25 x 3.0 mm;
font E: 1.0 x 2.0 mm

Paper Dimension
Operating System

Roll Paper: 57.5 ± 0.5 (w) x Ø 40.4 mm
Mobile iOS, Android and Windows, (security LEVELWEP, WPA, WPA2-Personal/Enterprise

Power Consumption

Wi-Fi: 9 hours (energy saving mode): 16 hours |
Bluetooth: 26 hours

Overall Dimension
Option

79.0 x 119.8 x 43.6 mm
Single Printer Charger/Cradle (OT-SC20),
Battery Pack (OT-BY20), Padded Case (OT-PC20),
Battery Spacer (OT-BS20)

TM PRINTER

Receipt Printers

TM-M10

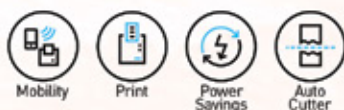

FOR PROJECT ONLY



Print Method	Thermal Line Printing
Print Speed	150 mm/sec
Character Size	Font A: 1.25 x 3.00 mm Font B: 1.13 x 3.00 mm Font C: 0.88 x 2.13 mm
Paper Dimension	Roll Paper: 79.5 ± 0.5 (W) x Ø 83; 57.5 ± 0.5 (W) x Ø 83
Operating System	Windows (APD, OPOS, epos SDK); Mac Drivers Linux Cup Drivers; iOS/Android/Web (epos SDK)
Power Consumption	Approx. 1.5 A (mean)
Overall Dimension	127 x 127 x 127 mm
Option	External Buzzer [OT-BZ20]; Wall Hanging Bracket [OT-WH30]

TM-M30II-SL

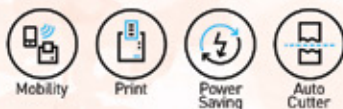

Print Method	Thermal line printing
Print Speed	200 mm/sec (Receipt Version)
Character Size	ANK Font A: 1.25 x 3 mm (Default); ANK Font B: 1.13 x 3 mm; Kanji Font: 3 x 3 mm
Paper Dimension	Roll paper: 79.5 ± 0.5 (W) x Ø 83, 57.5 ± 0.5 (W) x Ø 83
Interface	Built-in USB + Ethernet 10/100Base-T/TX [Ethernet Model]
Power Consumption	Approx. 1.5 A (mean)
Overall Dimension	127 x 127 x 127 mm
Option	External Buzzer [OT-BZ20]; Wall Hanging Bracket [OT-WH30]

TM PRINTER

Receipt Printers

TM-U220



Print



Power Saving



Print Method 9-pin, serial impact dot matrix
Print Speed Approx. 4.7 lps (at 40 columns, 16 cpi),
6.0 lps (at 30 columns, 16 cpi)

Character Size Font A: 1.6 mm [W] x 3.1 mm [H]
Font B: 1.2 mm [W] x 3.1 mm [H]

Paper Dimension Roll Paper : 57.5 ± 0.5 [W], 69.5 ± 0.5 [W], 76.0 ± 0.5 [W] x Ø 83.0 mm

Interface RS 232, Bi-directional Parallel, USB, Ethernet
Power Consumption Operating: Approx. 38 W [Mean]
Standby: Approx. 2.2 W [Mean]

Overall Dimension Type A: 160 [W] x 286 [D] x 157.5 [H] mm
Type B: 160 [W] x 248 [D] x 138.5 [H] mm
Type B: 160 [W] x 248 [D] x 138.5 [H] mm

Option Wall hanging bracket model: WH-10
(for type B, D)

TM-T70II



Mobility



Print



Power Saving



Auto Cutter



Print Method Thermal Line Printing
Print Speed Max. 170 mm/sec (80 mm model)
Max. 200 mm/sec (58 mm model)

Dot Density 180 dpi x 180 dpi [ANK model]
203 dpi x 203 dpi [Japanese / Multi-language model]

Paper Dimension Roll Paper: 79.5 mm ± 0.5 mm [W] x Ø 83.0 mm / 57.5 mm ± 0.5 mm [W] x Ø 83.0 mm

Interface USB + RS-232, USB + Parallel,
USB + Ethernet

Power Consumption Approx. 1.8 A [mean]

Overall Dimension 125 [W] x 194 [D] x 114 [H] mm

Option External buzzer unit, Connector cover

TM PRINTER

TM-T82X



Mobility



Print



Power Saving



Auto Cutter



Also available for 58mm paper width

Print Method	Thermal Line Printing
Print Speed	Max. 200 mm/sec
Character Size	0.88 × 2.13 mm / 1.25 × 3 mm, Hanji font: 3 × 3 mm, Thai font: 0.88 × 3 mm / 1.25 × 3 mm
Paper Dimension	Width and Roll Diameter: 79.5 ± 0.5 mm
Operating System	Windows, Mac, Linux
Power Consumption	Operating: Approx. 27.8 W Standby: Approx. 0.96 W
Overall Dimension	192 × 149 × 140 mm
Option	External buzzer

TM-T82III



Mobility



Print



Power Saving



Auto Cutter



Print Method	Thermal Line Printing
Print Speed	Max. 250 mm/sec
Character Size	0.88 × 2.13 mm / 1.25 × 3 mm, Hanji font: 3 × 3 mm, Thai font: 0.88 × 3 mm / 1.25 × 3 mm
Paper Dimension	Width: 79.5 ± 0.5mm Roll: 57.5 ± 0.5 × Ø 83.0 mm
Interface	Built-in USB + UIB (Serial or Parallel interface), Ethernet interface
Power Consumption	Operating: Approx. 1.5A Standby: Approx. 0.1A
Overall Dimension	199 × 140 × 146 mm
Option	External Wi-Fi Dongle OT-WL06, External buzzer unit

TM PRINTER

Receipt Printers

T88VI - iHUB



Mobility



Print



Power Saving



Auto Cutter



Print Method	Thermal Line Printing
Print Speed	Max. 350 mm/sec
Character Size	0.99 x 2.4 mm / 1.41 x 3.39 mm
Paper Dimension	Width: 79.5 ± 0.5 mm x 83.0 / 57.5 ± 0.5 x 83.0 mm
Interface	Built-in USB, Built-in Ethernet + Serial, USB Charging Port
Power Consumption	Approx. 27.4 W
Overall Dimension	195 x 145 x 148 mm
Option	Wireless LAN: OT-WL02 [ELPAP10] Customer Display Unit: DM-D30, DM-D110 External Buzzer: OT-BZ20

TM-88VI



Mobility



Print



Power Saving



Auto Cutter



Print Method	Thermal Line Printing
Print Speed	Max. 350 mm/sec
Character Size	0.99 x 2.4 mm / 1.41 x 3.39 mm
Paper Dimension	79.5 ± 0.5 mm x 83.0 / 57.5 ± 0.5 x 83.0 mm
Interface	Built-in USB, Built-in Ethernet + UIB
Power Consumption	Approx. 27.6 W
Overall Dimension	195 x 145 x 148 mm
Option	Wireless LAN: OT-WL02 [ELPAP10] Customer Display Unit: DM-D30, DM-D110 Wall Hanging Unit: WH-10 External Buzzer: OT-BZ20

TM PRINTER

TM-U950



Mobility

Print

Power Saving

Auto Cutter



Print Method	9-pin serial impact dot matrix
Print Speed	Approx. 311 / 233 cps
Character Size	1.6 mm x 3.1 mm / 1.3 mm x 3.1 mm
Paper Dimension	69.50 ± 0.50 (W) mm x Ø 83.00 mm
Interface	RS-232, Drawer kick-out, Customer Display, Bidirectional parallel
Power Consumption	Standby: 0.3 A, Mean: 1.8 A
Overall Dimension	251 x 298 x 195 mm
Option	MICR device

TM-L90



Mobility

Print

Power Saving

Auto Cutter



Technology	Thermal line
Print Resolution	203 x 203 dpi
Type Width	Receipt: Max. 72 mm Label: Max. 70 mm
Max. Print Speed	Max. 150 mm/sec
Interface	Built-in USB + 25-pin serial, with optional parallel and ethernet interface modules
Operating System	Microsoft Windows 8 / 7 / Vista / XP / POS Ready / Server 2012 / Server 2008 / Server 2003
Power Consumption	Operating: Approx. 1.8 A (mean) Standby: Approx. 0.1 A
Overall Dimension	148 x 140 x 203 mm
Weight	Approx. 1.9 kg

PEELER & LFC MODEL ALSO AVAILABLE

TM PRINTER

Receipt Printer

TM-L100



Mobility



Print



Power Saving



Auto Cutter



NEW PRODUCT

Technology	Thermal line
Print Resolution	203 x 203 dpi
Type Width	Receipt: Max. 72 mm Label: Max. 70 mm
Max. Print Speed	Max. 150 mm/sec
Interface	Built-in USB + 25-pin serial, with optional parallel and ethernet interface modules
Operating System	Microsoft Windows 8 / 7 / Vista / XP / POS Ready / Server 2012 / Server 2008 / Server 2003
Power Consumption	Operating: Approx. 1.8 A (mean) Standby: Approx. 0.1 A
Overall Dimension	148 x 140 x 203 mm
Weight	Approx. 1.9 kg

PEELER & LFC MODEL ALSO AVAILABLE

Receipt & Slip Printer

TM-H6000V



Mobility



Print



Power Saving



Auto Cutter



Print Method	9-pin serial impact dot matrix
Print Speed	350 mm/sec
Character Size	1.41 mm [W] x 3.39 mm [H] / 0.99 mm [W] x 2.4 mm [H]
Paper Dimension	79.50 ± 0.50 [W] mm x Ø 83.00 mm; 57.50 ± 0.50 [W] mm x Ø 83.00 mm
Interface	RS-232, USB 2.0 Type B, Drawer kick-out, Customer Display
Power Consumption	Approx. 22W
Overall Dimension	186 x 278 x 181 mm
Option	Endorsement printer (E/P), MICR device, Validation

TM PRINTER

Slip Printers

TM-U590



Mobility



Print



Power Saving



Auto Cutter



Print Method
Print Speed
Character Size
Paper Dimension

9-pin serial impact dot matrix
Approx. 233 / 311 cps
1.6 mm x 3.1 mm / 1.3 mm x 3.1 mm
Roll Paper (Receipt / Journal): 69.5 ± 0.5 (W) x Ø
83.0 mm; Slip: 70 (W) x 70 mm (L) - 210 (W) x
297 mm (L)

Interface
Power Consumption

RS-232, Drawer kick-out, Customer Display
Approx. 1.8 A (mean)

MCBF: 29,000,000 lines

Autocutter: -

Overall Dimension
Option

252 x 205 x 185 mm
USB, Ethernet

TM-U295



Mobility



Print



Power Saving



Auto Cutter



Print Method
Print Speed
Character Size

7-pin, Shuttle Impact Dot Matrix
Approx. 1.9 - 2.3 lps
1.6 (W) x 2.9 (H) / 1.3 (W) x 2.9 (H) mm
Thai Font Size: 1.6 (W) x 8.7 (H) /
1.9 (W) x 8.7 (H) mm

Paper Dimension

80(W) x 69(L) to 182 (W) x 257 (L) mm

Interface
Power Consumption
Reliability

RS-232 / Bi-directional Parallel

Approx. 600 mA (mean)

MCBF: 7,000,000 lines

Autocutter: -

Overall Dimension

180 x 290.5 x 101.5 mm

TM PRINTER

Airline (Ticketing) Printer

TM-L500A



Mobility



Print



Power Saving



Auto Cutter

FOR PROJECT ONLY



Print Method Print Speed

Thermal Line Printing
Max 250 mm/sec with optional roll paper holder*1; Boarding Pass: 150 mm/sec (depending on media quality); Baggage Tag: 200 mm/sec (depending on media quality)

Dot Density Paper Dimension

16.7 cpi / 12.5 cpi
Fanfold paper width: 54.0 ± 0.5 mm, 79.5 ± 0.5 mm, 82.5 ± 0.5 mm
Roll paper width & diameter: 54.0 ± 0.5 mm × Ø 184.2 mm, 79.5 ± 0.5 mm × Ø 184.2 mm, 82.5 ± 0.5 mm × Ø 184.2mm

Interface

USB + RS232 (9-Pin Serial), RS232 (25-pin Serial), Ethernet

Power Consumption

Boarding Pass: Approx. 20.3W [at 230V] / Approx. 20.5W [at 115V]; Baggage Tag: Approx. 34.4W [at 230V] / Approx. 35.8W [at 115V]

Overall Dimension Option

236 x 156 x 148 mm
Roll Paper Holder: SU-RPL500 (for roll paper with 76.2 mm inner diameter core), SU-RPL500B (for roll paper with 76.2 mm and 31.75 mm inner diameter core)

TM Printer Consumable

POSC		
Material Code	Description	Product
C43S015350	ERC-03(B) RIBBON CASSETTE	M-204 / 210V / 210V (C) / 220 Series / 240
C43S015352	ERC-05(B) RIBBON CASSETTE	M-150II
C43S015354	ERC-09(B) RIBBON CASSETTE	M-160/180/190
C43S015356	ERC-09(B) RIBBON CASSETTE	
C43S015358	ERC-18(B) RIBBON CASSETTE	M-2630 Series / 2640 Series / 2660 Series
C43S015360	ERC-22(B) RIBBON CASSETTE	M-180 / 190 / 190G
C43S015366	ERC-27(B) RIBBON CASSETTE	TM-290/U295 M-290
C43S015369	ERC-31(B) RIBBON CASSETTE	TM-H5000II / 5200 / U950 / U925 / U590 / M-930
C43S015371	ERC-32(B) RIBBON CASSETTE	TM-H6000II / U675 / RP-U420 / M-U-420 / 820 Series
C43S015374	ERC-38(B) RIBBON CASSETTE	TM-U220 / U210 / U230 / U325 / U375 / 210AR / U300
C43S015376	ERC-38(B/R) RIBBON CASSETTE	TM-U220 / U210 / U230 / U325 / U375 / 210AR / U300

NEXT-GENERATION POS SOLUTIONS FOR YOUR BUSINESS.



Thermal
Desktop Printers



Portable
Thermal Printers



Thermal
Label Printers



Dot Matrix
Printers



Hybrid
Printers



IT'S IN THE DETAILS.

EPSON

www.epson.co.id/labelprintersandpresses

LABEL INKJET PRINTER

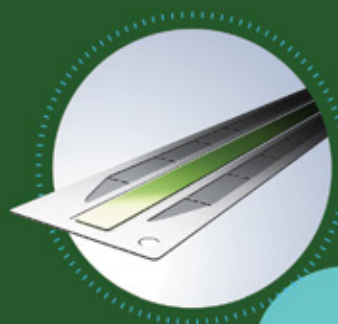

LABEL INKJET PRINTER

MENGAPA MEMILIH LABEL INKJET PRINTER ?

Epson Label Inkjet Printer menghadirkan label warna berkualitas tinggi sesuai kebutuhan untuk meningkatkan efisiensi dan mengurangi biaya pelabelan. Dengan cetakan tinggi kecepatan hingga 103mm per detik, resolusi dan keandalan yang sangat baik, printer ini adalah pilihan yang sempurna untuk industri, kimia, pergudangan, aplikasi pelabelan medis dan lainnya.

Superior Print Quality

Memastikan hasil cetak gambar yang tajam di setiap label. Epson MicroPiezo® inkjet technology dengan tinta pigmen kami memastikan label yang jernih, teks yang jelas, mudah dibaca, barcode dan grafik yang dinamis yang tahan lama, cepat kering dan tahan luntur. Hasil cetak tahan terhadap noda dan air, bahkan di atas kertas.

Epson pigment ink

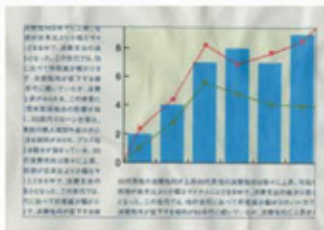

Dye-based ink

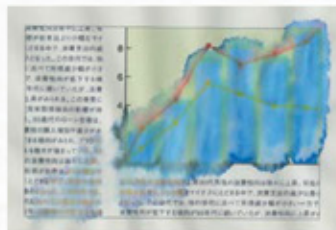

Berbagai Macam Media

Cetak pada berbagai bahan dan nikmati label warna sesuai kebutuhan. Mulai dari polos, sintetis, matte ke glossy, Printer label Epson memastikan label dengan kualitas cetak superior, memberi Anda gambar yang tajam. Printer label ini juga dapat mencetak pada bahan gulungan, lipatan, die cut atau bahan label bersambung.



Premium matte Ticket



Premium matte label



PE matte label

LABEL INKJET PRINTER

ColourWorks Label Inkjet Printers

CW-C4050

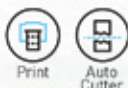

Print

Auto
Cutter



Print Technology	Serial Inkjet PrecisionCore TFP® with Nozzle Verification Technology
Print Resolution	Up to 1,200 x 1,200 dp
Colour	CMYK + Matte Black
Printing Width	Max. 108 mm
Printing Speed	Max. Speed (300x600dpi): 100mm/sec Max. Speed for Glossy Media (600x600dpi): 48mm/sec when printing 101.6mm Width
Interfaces	Hi-Speed USB 2.0 and Ethernet (100BASE-TX /10BASE-T) [Use of Optional product OT-WL06]
Media Type	Plain, Matte, Textured, Synthetic, Glossy, High glossy, Wristband
External Roll Diameter	Max. 101.6 mm
Power Consumption	Printing: Approx. 28.2W [mean] Standby: Approx. 2.6W [mean]
Dimensions	283 x 310 x 285 mm
Weight	Approx. 13.0 kg

CW-C6550P



Print

Batch
Printing

High
Capacity

Auto
Peeler



Print Technology	Serial Inkjet PrecisionCore TFP® with Nozzle Verification Technology
Print Resolution	1200 x 1200 dpi (max.)
Colour	CMYK
Printing Width	Max. 211.9mm [A4 Size]
Printing Speed	Max speed (300x600dpi): 85 mm/sec. Max speed for Glossy media (600x600dpi): 34 mm/sec. *When printing 203.2 mm width
Interfaces	US 2.0 High-Speed, Ethernet 10/100 BASE-T Extended: Dsub-25 pin
Media Type	Matte, synthetic, glossy, high glossy
External Roll Diameter	Max. 152.4 mm
Power Consumption	Printing: Approx. 38.7W Standby: 5.82W
Dimensions	515 x 444 x 326 mm
Weight	Approx. 26.3 kg

LABEL INKJET PRINTER

ColourWorks Label Inkjet Printers

CW-C7510G



Print

Batch
Printing

High
Capacity

Auto
Cutter



Print Technology PrecisionCore TFP® with Nozzle Verification Technology

Print Resolution 1,200 x 600 dpi

Colour CMYK

Printing Width 4.1" (104mm) max.

Printing Speed 300 mm/sec.

Interfaces USB 2.0 High-Speed, Ethernet 10/100 BASE-T

Extended: Dsub-15 pin

Media Type Plain, matte, synthetic, glossy

External Roll Diameter Max. 203.2 mm

Power Consumption Printing: Approx. 84W

Standby: Approx. 5.1W

Dimensions 392 x 598 x 395 mm

Weight Approx. 37.0 kg

LABEL INKJET PRINTER

ColourWorks Label Inkjet Printers

CW-C6050A



Print Technology	Serial Inkjet PrecisionCore TFP® with Nozzle Verification Technology
Print Resolution	1,200 x 1,200 dpi (Max.)
Colour	CMYK
Printing Width	Max. 108 mm
Printing Speed	Max speed (300x600dpi): 119 mm/sec. Max speed for Glossy media (600x600dpi): 48 mm/sec; *When printing 101.6 mm width
Interfaces	USB 2.0 High-Speed, Ethernet 10/100 BASE-T Extended: Dsub-25 pin
Media Type	Matte, synthetic, glossy, high glossy
External Roll Diameter	Max. 203.2 mm
Power Consumption	Printing: Approx. 39.4W Standby: Approx. 7.51W
Dimensions	565 x 340 x 326 mm
Weight	Approx. 22.5 kg

CW-C6050P



Print Technology	Serial Inkjet PrecisionCore TFP® with Nozzle Verification Technology
Print Resolution	1,200 x 1,200 dpi (Max.)
Colour	CMYK
Printing Width	Max. 108 mm
Printing Speed	Max speed (300x600dpi): 119mm/sec. Max speed for Glossy media (600x600dpi): 48 mm/sec. *When printing 101.6 mm width
Interfaces	US 2.0 High-Speed, Ethernet 10/100 BASE-T Extended: Dsub-25 pin
Media Type	Matte, synthetic, glossy, high glossy
External Roll Diameter	Max. 203.2 mm
Power Consumption	Printing: Approx. 39.4W Standby: Approx. 7.51W
Dimensions	565 x 340 x 326 mm
Weight	Approx. 22.8 kg

LABEL INKJET PRINTER

ColourWorks Label Inkjet Printers

CW-C6550A



Print

Batch
Printing

High
Capacity

Auto
Cutter



Print Technology Serial Inkjet PrecisionCore TFP® with Nozzle Verification Technology

Print Resolution 1,200 x 1,200 dpi (max.)

Colour CMYK

Printing Width Max. 211.9mm (A4 Size)

Printing Speed Max speed (300x600dpi): 85 mm/sec. Max speed for Glossy media (600x600dpi): 34 mm/sec. *When printing 203.2 mm width

Interfaces US 2.0 High-Speed, Ethernet 10/100 BASE-T Extended: Dsub-25 pin

Media Type Matte, synthetic, glossy, high glossy

External Roll Diameter Max. 152.4 mm

Power Consumption Printing: Approx. 38.7W

Standby: 5.82W

Dimensions 515 x 444 x 326 mm

Weight Approx. 25.5 kg

LABEL INKJET PRINTER

ColorWorks Labeljet Printer Consumable

Material Code	Description	Compatibility
ColorWorks Label InkJet Printer Consumable		
C33S020464	SJIC15P-464	TM-C3400
C33S020490	SJIC20P(K)-490: Ink Cartridge for TM-C3400BK	TM-C3400 BK
C33S020580	SJMB3500: Maintenance Box	TM-C3510
C33S020578	SJIC23P(K): Ink Cartridge for TM-C3510	
C33S020584	SJIC23P(C): Ink Cartridge for TM-C3510	
C33S020585	SJIC23P(M): Ink Cartridge for TM-C3510	
C33S020586	SJIC23P(Y): Ink Cartridge for TM-C3510	
C13S020559	GJIC4(K) Ink BK for Liatris-II	GP-C 830 / GP-M 830
C13S020560	GJIC4(C) Ink C for Liatris-II	GP-C 830
C13S020561	GJIC4(M) Ink M for Liatris-II	
C13S020562	GJIC4(Y) Ink Y for Liatris-II	
C33S020464	SJIC15P: 3-Colour for TM-C3400, Pigment Ink	TM-C3400
C33S020643	SJIC31P(K): Ink Cartridge	TM-C7510G
C33S020644	SJIC31P(C): Ink Cartridge	
C33S020645	SJIC31P(M): Ink Cartridge	
C33S020646	SJIC31P(Y): Ink Cartridge	
C33S020596	SJMB7500: MAINTENANCE BOX (C7500 Series)	
C13T44G100	SJIC40P-K: Ink Cartridge 70ml	CW-C6050/C6550
C13T44G200	SJIC40P-C: Ink Cartridge 70ml	
C13T44G300	SJIC40P-M: Ink Cartridge 70ml	
C13T44G400	SJIC40P-Y: Ink Cartridge 70ml	
C33S021501	SJMB6000: MAINT. BOX FOR CW-C6050/C6550	CW-C6050/C6550
C13T52R100	SJIC46P-BK ink	CW-C4050
C13T52R200	SJIC46P-C ink	
C13T52R300	SJIC46P-M ink	
C13T52R400	SJIC46P-Y ink	
C13T52R500	SJIC46P-MK ink	
C33S021601	SJMB4000	

www.epson.co.id/labelprinter

LABEL PRINTER



LABEL PRINTER

MENGAPA MEMILIH EPSON LABEL PRINTER ?

Dari organisasi rumah dan kantor yang sederhana hingga penandaan sistematis aset untuk sekolah, pabrik, rumah sakit, dan lainnya, Printer Epson LabelWorks menawarkan solusi profesional yang mudah digunakan untuk setiap kebutuhan pelabelan. Berbagai pilihan media label Epson mulai dari ukuran lebar, pola, warna dan gaya untuk membuat kualitas tinggi, label profesional dengan limbah minimal dan penghematan yang maksimum.



Weather
Resistant



Abrasion
Resistant



Temperature
Resistant



Water
Resistant



Chemical
Resistant

Penghematan biaya

Semua printer LabelWorks dirancang untuk efisiensi biaya yang lebih besar. Melalui penggunaan sisi signifikan margin yang lebih kecil, sehingga pemborosan berkurang. Dengan panjang pita lebih panjang yang ditawarkan Epson, hemat lebih banyak biaya operasional pencetakan.

Lead margins

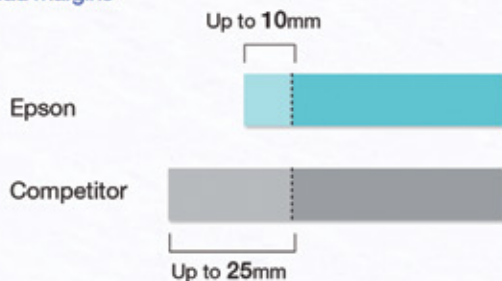

Tape savings

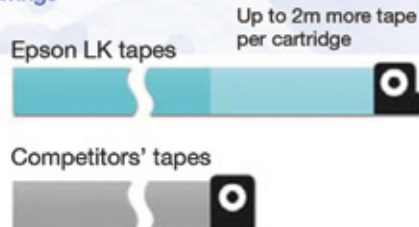



COMPREHENSIVE LABELLING SOLUTION FOR ADDED CREATIVITY & CONVENIENCE.

LabelWork Printer

IT'S IN THE DETAILS.

LABEL PRINTER

Compact and Efficient Helper



LW-K400



Low Cost
Per Print



Temperature
Resistant
Labels

Technology	Thermal Transfer
Print Resolution	180 dpi / 64 dot
Print Speed	Up to 6 mm/sec
Type Width	6, 9, 12, 18 mm
Display Size	130 x 48 dot
Keyboard Type	QWERTY / 61
Power Consumption	Battery 6 pcs AA (optional)
Overall Dimension	110 x 170 x 56 mm
Weight	0.41 kg

LW-700



Auto
Cutter



Low Cost
Per Print



Temperature
Resistant
Labels



Technology	Thermal Transfer
Print Resolution	180 dpi / 128 dot
Print Speed	Up to 25 mm/sec
Type Width	6, 9, 12, 18, 24 mm
Display Size	128 x 64 dot
Keyboard Type	QWERTY / 61
Operating System	Win7, Vista, XP (32/64 Bit), Mac OS
Overall Dimension	235 x 180 x 80 mm
Weight	0.77 kg

LABEL PRINTER

Professional Labelling



LW-C410



Auto
Cutter



Low Cost
Per Print



Temperature
Resistant
Labels

Technology	Thermal Transfer
Print Resolution	180 dpi / 96 dots
Tape Width	6, 9, 12, 18 mm
Max. Print Speed	9 mm / sec
Cartridge Type	LK Tape Cartridge
Max. Print Width	13.5 mm
Interface	Bluetooth
Batteries	6 pcs AA
Dimension	54 x 134 x 145 mm
Weight	0.41 kg

LW-600P



Auto
Cutter



Low Cost
Per Print



Temperature
Resistant
Labels



Technology	Thermal Transfer
Print Resolution	180 dpi / 128 dot
Tape Width	6, 9, 12, 18, 24 mm
Display Size	N/A
Keyboard Type	Dependent on user's PC
Operating System	Windows, Mac OS, Android & iOS
Power Consumption	Battery 6 pcs AA
Overall Dimension	55 x 132 x 146 mm
Weight	0.44 kg

LABEL PRINTER



LW-Z900FK

Auto
CutterLow Cost
Per PrintTemperature
Resistant
Labels

Technology	Thermal Transfer
Print Resolution	360 dpi / 384 dot
Print Speed	Up to 35 mm/sec
Type Width	6 - 36 mm
Display Size	N/A
Keyboard Type	QWERTY
Operating System	Windows XP, Vista, 7 - 10, MAC - OS
Power Consumption	Li-ion Battery (bundled) / 6AA (optional)
Overall Dimension	136 x 295 x 97 mm
Weight	1.25 kg



LW-Z700FK

Auto
CutterLow Cost
Per PrintTemperature
Resistant
Labels

Technology	Thermal Transfer
Print Resolution	180 dpi / 128 dot
Print Speed	Up to 30 mm/sec
Type Width	6 - 24 mm
Keyboard Size	QWERTY
Max. Print Speed	Up to 30 mm/sec
Operating System	Windows XP, Vista, 7, 8, 9, 10
Power Consumption	Li-ion Battery (Bundled) / 6AA (Optional)
Overall Dimension	136 x 298 x 90 mm
Weight	1.11 kg



LW-1000P

Auto
CutterLow Cost
Per PrintTemperature
Resistant
Labels

Technology	Thermal Transfer & Direct Thermal
Print Resolution	360 dpi / 384 dot
Type Width	6, 9, 12, 18, 24, 36 mm
Display Size	N/A
Keyboard Type	Dependent on user's PC
Operating System	Win7, Vista, XP (32/64 Bit), Mac OS
Interface	USB, Wi-Fi, LAN
Power Consumption	AC adapter
Overall Dimension	123 x 153 x 139 mm
Weight	1.08 kg

LABEL PRINTER

Professional Labelling

LW-Z5000WA



Auto
Cutter



Low Cost
Per Print



Temperature
Resistant
Labels



Technology	Thermal Transfer
Print Resolution	180 dpi / 128 dot
Print Speed	Up to 30 mm/sec
Tube Width	12 - 50 mm
Max. Print Speed	Up to 30 mm/sec
Operating System	Windows XP, Vista, 7, 8, 9, 10
Power Consumption	AC adapter
Overall Dimension	136 x 298 x 90 mm
Weight	1.11 kg

LW-Z5010BA



Auto
Cutter



Low Cost
Per Print



Temperature
Resistant
Labels



Technology	Thermal Transfer & Direct Thermal
Print Resolution	360 dpi / 384 dot
Tube Width	12 - 50 mm
Display Size	4.3 inch
Keyboard Type	Dependent on user's PC
Operating System	Win7, Vista, XP (32/64 Bit), Mac OS
Interface	USB, Wi-Fi, LAN
Power Consumption	AC adapter/Battery Li-ion
Overall Dimension	123 x 153 x 139 mm
Weight	1.08 kg

LABEL PRINTER

Label Printer Consumable

Remarks	Material Code	Description	Remarks	Material Code	Description
Compatible for Epson LabelWorks			Compatible for Epson LabelWorks		
Heat Shrink Tube	C53S654903	LK-4WBA3 - Black On White HT Shrink dia. 3mm	Consumable	C13S090009	Clean Stick A
	C53S654905	LK-4YBA3 - Black On Yellow HT Shrink dia. 3mm		C13S090011	Clean Stick B
	C53S654904	LK-4WBA5 - Black On White HT Shrink dia. 5mm		C13T639000	L-4033A Overprint Ink Cartridge (700ml)
	C53S654906	LK-4YBA5 - Black On Yellow HT Shrink dia. 5mm		C13T639100	L-4033A Photo Black Ink Cartridge (700ml)
	C53S656902	LK-6WBA11 - Black On White HT Shrink dia. 11mm		C13T639200	L-4033A Cyan Ink Cartridge (700ml)
	C53S656904	LK-6YBA11 - Black On Yellow HT Shrink dia. 11mm		C13T639300	L-4033A Magenta Ink Cartridge (700ml)
	C53S656903	LK-6WBA14 - Black On White HT Shrink dia. 14mm		C13T639400	L-4033A Yellow Ink Cartridge (700ml)
	C53S656905	LK-6YBA14 - Black On Yellow HT Shrink dia. 14mm		C13T639500	L-4033A Mate Black Ink Cartridge (700ml)
	C53S657903	LK-7WBA21 - Black On White HT Shrink dia. 21mm		C13T639600	L-4033A Orange Ink Cartridge (700ml)
	C53S657904	LK-7YBA21 - Black On Yellow HT Shrink dia. 21mm		C13T639700	L-4033A Green Ink Cartridge (700ml)
Die-Cut	C53S658901	LK-8WBWAA - Die-Cut (Circle)	C13T639800	L-4033A Moisture Liquid Cartridge (350ml)	
	C53S658902	LK-8WBWAB - Die-Cut (Oval)	C13T639A00	Uncoated Black Cartridge for L-4033A	
	C53S658903	LK-8WBWAC - Die-Cut (Rectangle)	C13T639B00	White Cartridge for L-4033A	
6mm	C53S652501	LK-2WBN - 6mm Black On White Tape	C13T639C00	Storage liquid for L-4033A	
9mm	C53S653501	LK-3WBN - 9mm Black On White Tape	C13T639D00	Moisture Liquid (700ml) for L-4033A	
	C53S653504	LK-3GBP - 9mm Black On Green	C13S400063	Swab Head A	
12mm	C53S653506	LK-3YBP - 9mm Black On Yellow	Consumable	C13S090009	Clean Stick A
	C53S654501	LK-4WBN - 12mm Black On White Tape		C13S090011	Clean Stick B
	C53S654502	LK-4WRN - 12mm Red On White Tape		C13S210062	Cloth for Web Cleaner
	C53S654503	LK-4WLN - 12mm Blue On White Tape		C13T799100	L-6034 Black Ink Cartridge (3L)
	C53S654505	LK-4BWV - 12mm White On White Tape		C13T799200	L-6034 Cyan Ink Cartridge (3L)
	C53S654506	LK-4SBM - 12mm Black On Silver Tape		C13T799300	L-6034 Magenta Ink Cartridge (3L)
	C53S654507	LK-4KBM - 12mm Black On Gold Tape		C13T799400	L-6034 Yellow Ink Cartridge (3L)
	C53S654508	LK-4WBQ - 12mm Black On White Iron-On		C13T799500	L-6034 D Varnish Ink Cartridge (3L)
	C53S654509	LK-4PBQ - 12mm Black On Pink Iron-On		C13T799600	L-6034 White Ink Cartridge (2.6L)
	C53S654510	LK-4KBK - 12mm Black On Gold (Ribbon)		C13T799800	L-6034 Storage Liquid (2.6L)
	C53S654511	LK-4PBK - 12mm Black On Pink (Ribbon)		7112440	Washing liquid - EDGAC (20 Liter)
	C53S654512	LK-4EAY - 12mm Gray On Polkadot Pink Tape			
	C53S654513	LK-4CAY - 12mm Gray On Blue Check Tape			
	C53S654514	LK-4TBN - 12mm Black On Transparent Tape			
	C53S654515	LK-4YBP - 12mm Black On Yellow Tape			
	C53S654518	LK-4LBP - 12mm Black On Blue			
	18mm	C53S655501		LK-5WBN - 18mm Black On White Tape	
C53S655502		LK-5WRN - 18mm Red On White Tape			
C53S655506		LK-5SBM - 18mm Black On Silver Tape			
C53S655507		LK-5KBM - 18mm Black On Gold Tape			
C53S655512		LK-5TBN - 18mm Black On Transparent Tape			
C53S655513		LK-5ZBU - 18mm Black On Glow-In-Dark Tape			
24mm	C53S655514	LK-5YBP - 18mm Black On Yellow Tape			
	C53S655519	LK-5GBP - 18mm Black On Green			
	C53S656501	LK-6WBN - 24mm Black On White Tape			
	C53S656503	LK-6BWV - 24mm White On Black Tape			
36mm	C53S656507	LK-6YBP - 24mm Black On Yellow Tape			
	C53S656901	LK-6WBC - 24mm Black on 1/3 White 2/3 Color Tape			
	C53S657501	LK-7WBN - 36mm Black On White Tape			
	C53S657503	LK-7RBP - 36mm Black On Red Tape			
	C53S657504	LK-7YBP - 36mm Black On Yellow Tape			
	C53S657506	LK-7LWV - 36mm White On Blue Tape			
	C53S657507	LK-7TBN - 36mm Black On Transparent			
C53S657508	LK-7GBP - 36mm Black On Green				
C53S657902	LK-7WBC - 36mm Black on 1/3 White 2/3 Color Tape				

www.epson.co.id/discpublisher

DISC PUBLISHER



DISC PUBLISHER

DISC PUBLISHER
DISCPRODUCER™ PP-50II/PP-100III/PP-100N

Discproducer combines Epson's market leading expertise in advanced inkjet printing and precision robotics to offer an efficient and highly reliable integrated disc publishing solution for a wide range of industries and applications. With Discproducer, fully automated Blu-Ray, DVD and CD publishing is just a push of a button away.

Unrivalled Performance with Cost Savings

Epson's industry-leading Micro Piezo print head and ink technology ensure uniform, stable ink droplets with virtually no satellites or misting, producing brilliant and crisp disc labels at a high resolution of up to 1440 dpi x 720 dpi.

Epson's Micro Piezo™ technology also protects against striation and ink bleed, and allows ultra-fine colour graduation plus razor-sharp text – even in small font sizes.

Instead of using the traditional whole cartridges, Discproducer utilises six individual high-capacity ink cartridges that can be easily replaced quickly, thus allowing you to print more while keeping running costs low.



Convenient Total Front-Operation

Discproducer is the only system in its class that offers the ergonomic advantages of total front-operation and status reporting.

Unlike other systems that allow publishing to continue without ink, Discproducer shows ink level status using an LED for each individual colour. This allows the printing process to be manually or automatically interrupted in case of a near-empty ink cartridge, thereby eliminating damage and waste.



High Precision and Reliability

Discproducer is built to withstand hard knocks and keep dust out. The solid body provides a sturdy housing for the intricate technologies within to run processes smoothly without any interruption.



Misfed and damaged discs are a thing of the past, thanks to the patented AcuGrip robotic arm which handles one disc at a time reliably. This reduces the risk of incurring scratches on the disc, often caused by conventional sliding mechanisms and prevents interruptions during unsupervised production, caused by mechanical blockage.

AcuGrip™



DISC PUBLISHER

Disc Producer Series

PP-100III



Cost Effective



Fastest Total Throughput



Quiet Operation



- Publishing Speed** CD: 30 discs/hour
DVD: 15 discs/hour
- Printing Only** CD: 60 discs/hour, bidirectional (fast mode)
DVD: 40 discs/hour, bidirectional (fine mode)
- Print specifications** Serial Serial inkJet Dot-Matrix, Six-color (Dye ink: C, LC, M, LM, Y, Bk) / 1,440 dpi x 720 dpi (fast mode) / 1,440 dpi x 1,440 dpi (fine mode) / 720 dpi x 720 dpi (PP-100AP Level3)
- CD/DVD Drives** 2 drives
- Supported Media** CD-R, DVD-R, DVD+R, DVD-R DL
- Interface** Hi-Speed USB
- Overall Dimensions** 377 (W) x 465 (D) x 348 (H) mm
- Mass** Approx. 24.0 kg
- Software** EPSON Total Disc Maker: Installed to the user's PC to publish discs/PP-100; EPSON Total Disc Monitor: Displays the status of jobs and devices; EPSON Printer driver for PP-100 Series; EPSON Total Disc Net Administrator: The web application for product setting, user management, job history management & authorization workflow (PP-100N only); TD Bridge: System incorporation tool to use the PP-100, PP-100N, PP-50 with other companies' applications. (Included CD does not have this software).

PP-100N



Cost Effective



Fastest Total Throughput



Quiet Operation



- Publishing Speed** CD: 30 discs/hour
DVD: 15 discs/hour
- Printing Only** CD: 60 discs/hour, bidirectional (fast mode)
DVD: 40 discs/hour, bidirectional (fine mode)
- Print specifications** Serial Serial inkJet Dot-Matrix, Six-color (Dye ink: C, LC, M, LM, Y, Bk) / 1,440 dpi x 720 dpi (fast mode) / 1,440 dpi x 1,440 dpi (fine mode) / 720 dpi x 720 dpi (PP-100AP Level3)
- CD/DVD Drives** 2 drives
- Supported Media** CD-R, DVD-R, DVD+R, DVD-R DL
- Interface** Ethernet
- Overall Dimensions** 377 (W) x 514 (D) x 348 (H) mm
- Mass** Approx. 25.0 kg
- Software** EPSON Total Disc Maker: Installed to the user's PC to publish discs/PP-100; EPSON Total Disc Monitor: Displays the status of jobs and devices; EPSON Printer driver for PP-100 Series; EPSON Total Disc Net Administrator: The web application for product setting, user management, job history management & authorization workflow (PP-100N only); TD Bridge: System incorporation tool to use the PP-100, PP-100N, PP-50 with other companies' applications. (Included CD does not have this software).

DISC PUBLISHER

PP-50II



Cost Effective Fastest Total Throughput Quiet Operation



- Publishing Speed** CD: 15 discs/hour
DVD: 8 discs/hour
- Printing Only** CD: 60 discs/hour, bidirectional (fast mode)
DVD: 40 discs/hour, bidirectional (fine mode)
- Print specifications** Serial InkJet Dot-Matrix, Six-color (Dye ink: C, LC, M, LM, Y, Bk) / 1,440 dpi x 720 dpi (fast mode) / 1,440 dpi x 1,440 dpi (fine mode) / 720 dpi x 720 dpi (PP-100AP Level3)
- CD/DVD Drives** 1 drives
- Supported Media** CD-R, DVD-R, DVD+R, DVD-R DL, DVD+R DL
Stackers 1, 2: 50 discs (Publishes up to 50 discs in a single job)
- Stacker Capacity** Stackers 3: 20 discs
- Interface** Hi-Speed USB
- Power Consumption** Approx. 40 W (mean)
- Overall Dimensions** 377 (W) x 465 (D) x 324 (H) mm
- Mass** Approx. 21.0 kg
- Reliability** Product life: 15,000 discs or 5 years CD/DVD drive: 15,000 times (number of writing), 1,000 hours (writing time)
- Software** EPSON Total Disc Maker: Installed to the user's PC to publish discs/PP-100; EPSON Total Disc Monitor: Displays the status of jobs and devices; EPSON Printer driver for PP-100 Series; EPSON Total Disc Net Administrator: The web application for product setting, user management, job history management & authorization workflow (PP-100N only); TD Bridge: System incorporation tool to use the PP-100, PP-100N, PP-50 with other companies' applications. (Included CD does not have this software).

www.epson.co.id/dotmatrix

DOT MATRIX PRINTER



**QUALITY
& VALUE**
GENUINE SUPPLIES



DOT MATRIX PRINTER

MENGAPA MEMILIH PRINTER DOT MATRIX EPSON?

Printer Epson dot matrix adalah partner ideal Anda untuk pencetakan tugas berat dengan biaya rendah melalui kemampuannya untuk bekerja dengan Multi-part. Printer ini hanya membutuhkan penggantian pita sesekali karena pita tinta yang digunakan tetap berfungsi bahkan setelah penyimpanan lama, berfungsi sebagai pekerja keras yang ideal untuk bisnis Anda.

ESC / P yang dikembangkan Epson adalah kontrol untuk printer dot matrix standar dunia. Ini berarti terlepas dari platform, perangkat lunak atau jaringan yang Anda gunakan, sehingga dapat langsung menyambungkan dan menjalankan printer Anda.



Quality and Value

Pita asli Epson memastikan hasil lebih besar, kualitas lebih baik, dan umur lebih panjang



Maximise Productivity

Cetak di atas kertas bersambung dan kertas belapis untuk membuat salinan karbon yang memenuhi kebutuhan spesifik bisnis Anda



Cost-efficient

Nikmati biaya kepemilikan yang rendah dengan biaya cetak yang kompetitif per halaman melalui pita tinta yang ekonomis.



Superior Reliability

dirancang untuk bertahan dengan kualitas yang kuat dan kinerja yang konsisten.



Hassle-free

Tengan pita tinta yang tahan lama dan waktu rata-rata yang tinggi di antara kegagalan (MTBF), Anda akan mendapatkan waktu henti yang minimal.

DOT MATRIX PRINTER

SIDM 9-Pin Printers



LX-310



Print



Cost Effective



High Speed Printing

Print Method	Impact dot matrix
Number Of Pins	9 pins
Print Speed	High speed: 347 / 357 / 390 cps Draft: 260 / 312 / 223 cps NLQ: 65 / 78 / 55 / 47 / 56 cps
Reliability	Printhead life: Approx. 400 million strokes/wire MVBf: Approx. 20 million lines [Except print head] MTBF: Approx. 10,000 POH [25% Duty]
Ribbon Life	Approx. 4.0 million characters
Operating System	Microsoft® Windows® 2000 / XP / Vista / 7 / 8 / 8.1 / 10
Memory Buffer	128 KB
Interface	Bi-directional parallel [IEEE-1284 nibble mode supported], USB 2.0 Full-Speed, Serial
Power Consumption	Approx. 27W
Dimension	362 x 275 x 154 mm
Weight	Approx. 4.1 kg



FX-2190II



Print



Cost Effective



High Speed Printing

Print Method	Impact dot matrix
Number Of Pins	9 pins
Print Speed	Ultra speed: 615 / 738 cps High speed: 612 / 694 cps Draft: 463 / 555 cps
Reliability	Printhead life: 400 million strokes/wire MVBf: 52 million lines [except print head] MTBF: 25,000 Power On Hours [POH] [25% Duty]
Ribbon Life	Approx. 12 million characters
Operating System	Microsoft Windows XP / Vista / 7 / 8 / 10
Memory Buffer	128 KB
Interface	USB 2.0, Bi-directional parallel [IEEE-1284 nibble mode supported]
Power Consumption	Approx. 54W
Dimension	612 x 375 x 176.5 mm
Weight	Approx. 9.4 kg

DOT MATRIX PRINTER

SIDM 9-Pin Printers

FX-2190IIN



Print

Cost Effective

High Speed Printing



Print Method	Impact dot matrix
Number Of Pins	9 pins
Print Speed	Ultra speed: 615 / 738 cps High speed: 612 / 694 cps Draft: 463 / 555 cps
Reliability	Printhead life: 400 million strokes/wire MVBF: 52 million lines (except print head) MTBF: 25,000 Power On Hours (POH) (25% Duty)
Ribbon Life	Approx. 12 million characters
Operating System	Microsoft Windows XP / Vista / 7 / 8 / 10
Memory Buffer	128 KB
Interface	USB 2.0, Bi-directional parallel (IEEE-1284 nibble mode supported) Serial, 100base-TX wired LAN
Power Consumption	Approx. 54W
Dimension	612 x 375 x 176.5 mm
Weight	Approx. 9.4 kg

DFX-9000



Print

Cost Effective

High Speed Printing



Print Method	Impact dot matrix
Number Of Pins	36 pins
Print Speed	High speed: 1,550 / 1,450 cps Draft: 1,320 x 1,320 cps NLQ: 330 / 330 cps
Reliability	Printhead life: 200 million strokes/wire MVBF: 133 million lines (except print head) MTBF: 20,000 POH (25% duty cycle)
Ribbon Life	15 million characters
Operating System	Microsoft Windows® Me / XP / Vista® / Windows 7 / 8 / 8.1 / 10 (32/64bit)
Memory Buffer	128 KB
Interface	Bi-directional parallel interface (IEEE-1284 nibble mode supported), Serial I/F, USB 2.0 (Full Speed) I/F
Power Consumption	Approx. 185W
Dimension	700 x 378 x 363 mm
Weight	Approx. 34 kg

DOT MATRIX PRINTER

SIDM 24-Pin Printers



LQ-310



Print



Cost Effective



High Speed Printing

Print Method	Impact dot matrix
Number Of Pins	24 pins
Print Speed	High speed: 347 / 416 cps Draft: 260 / 312 / 390 cps NLQ: 86 / 103 / 129 cps
Reliability	Printhead life: Approx. 400 million strokes/wire MVBf: Approx. 20 million lines (except print head) MTBF: Approx. 10,000 POH (25% Duty)
Ribbon Life	Approx. 2.5 million characters
Operating System	Windows 95 / 98 / 2000 / Me / XP / Vista / 7 / 8 / 8.1 / 10
Memory Buffer	128 KB
Interface	Bi-directional parallel interface (IEEE-1284 nibble mode supported), USB 2.0 Full-Speed, Serial
Power Consumption	Approx. 24W
Dimension	362 x 275 x 154 mm
Weight	Approx. 4.1 kg



LQ-590II



Print



Cost Effective



High Speed Printing

Print Method	Impact dot matrix
Number Of Pins	24 pins
Print Speed	Ultra high speed: 550 cps High speed: 487 / 584 cps Draft: 366 / 439 cps
Reliability	Printhead life: 400 million strokes / wire MVBf: 50 million lines (except print head) MTBF: 25,000 Power On Hours (POH) (25% Duty)
Ribbon Life	Approx. 5 million characters
Operating System	Microsoft Windows XP / Vista / 7 / 8 / 10
Memory Buffer	128 KB
Interface	USB 2.0, Bi-directional parallel, (IEEE-1284 nibble mode supported)
Power Consumption	Approx. 49W
Dimension	414 x 320 x 176.5 mm
Weight	Approx. 7.2 kg

DOT MATRIX PRINTER

SIDM 24-Pin Printers

LQ-590IIN



Print

Cost Effective

High Speed Printing



Print Method	Impact dot matrix
Number Of Pins	24 pins
Print Speed	Ultra high speed: 550 cps High speed: 487 / 584 cps Draft: 366 / 439 cps
Reliability	Printhead life: 400 million strokes / wire MVBF: 50 million lines (except print head) MTBF: 25,000 Power On Hours (POH) (25% Duty)
Ribbon Life	Approx. 5 million characters
Operating System	Microsoft Windows XP / Vista / 7 / 8 / 10
Memory Buffer Interface	128 KB USB 2.0, Bi-directional parallel (IEEE-1284 nibble mode supported), Serial, 100base-Tx wired LAN
Power Consumption	Approx. 49W
Dimension	414 x 320 x 176.5 mm
Weight	Approx. 7.2 kg

LQ-2090II



Print

Cost Effective

High Speed Printing



Print Method	Impact dot matrix
Number Of Pins	24 pins
Print Speed	Ultra speed: 550 cps High speed: 487 / 584 cps Draft: 366 / 439 cps
Reliability	Printhead life: 400 million stroke/wire MVBF: 50 million lines (except print head) MTBF: 25,000 Power On Hours (POH) (25% Duty)
Ribbon Life	Approx. 8 million characters
Operating System	Microsoft Windows XP / Vista / 7 / 8 / 10
Memory Buffer Interface	128 KB USB 2.0, Bi-directional parallel (IEEE-1284 nibble mode supported)
Power Consumption	Approx. 49W
Dimension	612 x 375 x 176.5 mm
Weight	Approx. 9.4 kg

DOT MATRIX PRINTER

SIDM 24-Pin Printers



LQ-780



Print



Cost Effective



High Speed Printing

Print Method	Impact dot matrix
Number Of Pins	24 pins
Print Speed	High speed: 487 / 584 cps Draft: 366 / 439 / 549 cps LQ: 121 / 145 / 181 cps
Reliability	Printhead life: 400 million strokes/wire MVBF: 40 million lines (Except print head) MTBF: 20,000Hrs POH (25% duty cycle)
Ribbon Life	Approx. 10 million characters
Operating System	Microsoft Windows XP / Vista / 7 / 8 / 8.1 / 10 / 11
Memory Buffer Interface	128 KB Bi-directional Parallel (IEEE 1284 Nibble mode support), USB 2.0 (Full Speed Mode)
Power Consumption	Approx. 46W
Dimension	480 x 301.3 x 211 mm
Weight	Approx. 6.7 kg



LQ-780N



Print



Cost Effective



High Speed Printing

Print Method	Impact dot matrix
Number Of Pins	24 pins
Print Speed	High speed: 487 / 584 cps Draft: 366 / 439 / 549 cps LQ: 121 / 145 / 181 cps
Reliability	Printhead life: 400 million strokes/wire MVBF: 40 million lines (Except print head) MTBF: 20,000Hrs POH (25% duty cycle)
Ribbon Life	Approx. 10 million characters
Operating System	Microsoft Windows XP / Vista / 7 / 8 / 8.1 / 10 / 11
Memory Buffer Interface	128 KB Bi-directional Parallel (IEEE 1284 Nibble mode support), USB 2.0 (Full Speed Mode), LAN (for N models only)
Power Consumption	Approx. 46W
Dimension	480 x 301.3 x 211 mm
Weight	Approx. 6.7 kg

DOT MATRIX PRINTER

SIDM 24-Pin Printers

LQ-2090IIN



Print Method	Impact dot matrix
Number Of Pins	24 pins
Print Speed	Ultra high speed: 550 cps High speed: 487 / 584 cps Draft: 366 / 439 cps
Reliability	Printhead life: 400 million strokes / wire MVBF: 50 million lines (except print head) MTBF: 25,000 Power On Hours (POH) [25% Duty]
Ribbon Life	Approx. 8 million characters
Operating System	Microsoft Windows XP / Vista / 7 / 8 / 10
Memory Buffer	128 KB
Interface	USB 2.0, Bi-directional parallel (IEEE-1284 nibble mode supported), Serial, 100base-Tx wired LAN
Power Consumption	Operating Approx. 49W/Sleep Mode Approx. 0.8W
Dimension	612 x 375 x 176.5mm
Weight	9.4kg

LQ-2190



Print Method	Impact dot matrix
Number Of Pins	24 pins
Print Speed	High speed: 480 / 576 cps Draft: 360 / 432 / 540 cps NLQ: 120 / 144 / 180 cps
Reliability	Printhead life: Approx. 400 million strokes/wire MVBF: Approx. 40 million lines (except print head) MTBF: 20,000 Power On Hours (POH) [25% Duty]
Ribbon Life	Approx. 15 million characters
Operating System	Microsoft® Windows® 2000 / XP / Vista / 7 / 8 / 8.1 / 10
Memory Buffer	128 KB
Interface	Bi-directional Parallel Interface (IEEE-1284 nibble mode supported), USB 2.0 (Full Speed), Type B I/F Level 2 (Option)
Power Consumption	Approx. 46W
Dimension	639 x 402 x 256 mm
Weight	Approx. 13 kg

DOT MATRIX PRINTER

SIDM 48-Pin Printers

DLQ-3500IIN STD



Print Method	Impact dot matrix
Number Of Pins	24 pins x 2 (total 48 pins)
Print Speed	High speed: 550 cps Draft: 550 cps LQ: 195 cps
Reliability	MVBF: 25 million lines MTBF: 10,000 Power On Hours (POH) Printhead life: 200 million strokes / wire
Ribbon Life	Approx. 6 million characters
Operating System	Microsoft Windows® XP / Vista / 7 / 8 / 10
Memory Buffer	128 KB
Interface	USB 2.0, Bi-directional parallel (IEEE-1284 nibble mode supported), 100base-Tx wired LAN
Power Consumption	Approx. 78 W
Dimension	661 x 433 x 276 mm
Weight	18.9 kg

RELIABLE, SEAMLESS INTEGRATION MAKES ALL THE DIFFERENCE.



At Epson, we focus on the details. Epson passbook printers are a definite sleek and sound investment for your organisation. Based on Epson's experience in delivering industry-standard solutions, these printers help you run and grow your business and stay in control of your operations. With the flexible and versatile PLQ-35/50 series passbook printers, you can increase service productivity and operational efficiency while maintaining a low total cost of ownership.



Print



High Speed
Printing



Colour LED
Control Panel



Cost Effective



Power
Savings

1.44" Colour LED Control Panel

With the new feature of 1.44" colour LED control panel* for easy settings, configuration and checking printer status without wasting paper.

Fast Print Speed

Maximise productivity with faster printing speed of up to 630 cps (10 cpi).

Enhanced Reliability

Better reliability with printhead life up to 600 millions strokes/wire (in characters) and mean-time-between failure (MTBF) of up to 35,000 POH (power on hours).

DOT MATRIX PRINTER

Passbook Printers



PLQ-35



Print



High Speed Printing



Colour LED Control Panel



Cost Effective



Power Savings

Print Method
Printer Speed

24 pins Impact Dot Matrix
PR2 Emulation (10 cpi): 540 Ultra High Speed Draft/ 480 High Speed Draft/ 360 Draft/ 180 NLQ/ 120 LQ
ESC/P2, Others (10 cpi): 540 Ultra High Speed Draft/ 480 High Speed Draft/ 360 Draft/ 120 LQ
IBM 4722 (10 cpi): 360 Standard Text/ 240 NLQ

Interface

Bi-directional parallel interface (IEEE-1284 nibble mode supported), Serial I/F, High Speed USB 2.0

Power Consumption

61W Operation/ 0.7 W Sleep Mode

Dimensions

384 x 280 x 203 mm

Weight

7.8 kg



PLQ-50



Print



Cost Effective



High Speed Printing

Print Method
Number Of Pins
Print Speed

Impact dot matrix
24 pins
Ultra high speed: 630 cps
High speed: 560 cps
Draft: 420 cps

Reliability

Printhead life: 600 million strokes/wire
MVBF: 24 million lines
MTBF: 35000 POH

Ribbon Life
Operating System

Approx. 5 million characters
Microsoft Windows XP, Vista, 7, 8, 8.1, 10, Windows Server 2003, 2008, 2012, 2016

Interface

Bi-directional parallel interface (IEEE-1284 nibble mode supported), Serial I/F, High Speed USB 2.0

Power Consumption

Approx. 77W

Dimension

384 x 280 x 203 mm

Weight

Approx. 7.9 kg

DOT MATRIX PRINTER

Dot Matrix Consumable

Product Code	Ribbon Cartridges	Main Unit	Ribbon Specifications
C13S015516	Ribbon, #8750(B), Asia	LX-300 / 300+ / 300+II	3 mil character / 17.7m, 58 ft x 13mm, 0.5"
C13S015506	Ribbon, #7753(B), Asia	LQ-300 / 300+II / 580 / LQ-200	2 mil character / 10m, 32.8 ft x 13mm, 0.5"
C13S015632	Ribbon Cartridge (S015632)	LX-310	4 mil character / 18.0m, 59 ft x 13mm, 0.5"
C13S015639	Ribbon Cartridge (S015634)	LQ-310	2.5 mil character / 10m, 32.8 ft x 13mm, 0.5"
C13S015531	Ribbon, S015086(B), Asia	LQ-2070 / 2180 / 2080 / 2190 FX-2180	3 mil character / 17.79 pin - 8 mil character / 60m, 196.8 ft x 13mm, 0.5" 24 pin - 12 mil character / 70m x 13mm, 0.5" 58 ft x 13mm, 0.5"
C13S015520	Ribbon, #8755(B), Asia	LX-1050 / 1170 / 1170 II FX-1170	3 mil character / 17.7m, 58 ft x 13mm, 0.5"
C13S015511	Ribbon, #7754(B), Asia	LQ-1150 / 1150 II	2 mil character / 12.4m, 40.6 ft x 13mm, 0.5"
C13S015589	Ribbon, S015337(B), Asia	LQ-590	5 mil character / 17m, 55.7 ft x 13mm, 0.5"
C13S015584	Ribbon, S015327(B), Asia	FX-2190 / FX-2175	8 mil character / 32m, 104.9 ft x 13mm, 0.5"
C13S015586	Ribbon, S015336(B), Asia	LQ-2090	8 mil character / 32m, 104.9 ft x 13mm, 0.5"
C13S015577	Ribbon, #8766(B), Asia	DFX-5000 / 5000+ / 8000 / 8500	15 mil character / 69.6m, 227.9 ft x 13mm, 0.5"
C13S015658	Ribbon, S015630(B), Asia	LQ-780/780N	10 mil character / 32.0m, 104.9ft x 13mm, 0.5"
C13S015508	Ribbon, S015016(B), Asia	LQ-670 / 680 / 680 Pro	2 mil character / 10m, 32.8 ft x 13mm, 0.5"
C13S015582	Ribbon, S015290(B), Asia	LQ-630	2 mil character / 8m, 26.2 ft x 13mm, 0.5"
C13S015587	Ribbon, S015066(B), STD	DLQ-3000 / 3000+ / 3500	6 mil character / 16.75m, 54.9 ft x 25.5mm, 1.0"
C13S015505	Ribbon, S015384(B), STD	DFX-9000	15 mil character / 70m, 229.6 ft x 13mm, 0.5"
C13S015585	Ribbon, S015329(B), Asia	FX-890 / FX-875	7.5 mil character / 17.0m:55.7ft, 13mm, 0.5"
C13S015592	Ribbon, S015339 (B), ESP, 3PCS	PLQ-20 / M / D / DM PLQ-35/PLQ-50	5 mil character / 36m, 118 ft x 6.5mm, 0.25"
C13S010074	Fabric Ribbon Pack Refill for S015086	LQ2070 / 2180 / 2080 / 2190 FX-2180	9 pin - 8 mil character / 60m, 196.8 ft x 13mm, 0.5" 24 pin - 12 mil character / 60m x 13mm, 0.5"
C13S010066	Fabric Ribbon Pack Refill for #7753 & #7754	LQ300 / 300+II / 580 and LQ1150 / 1150 II	2 mil character / 12.4m, 40.6 ft x 13mm, 0.5"
C13S010068	Fabric Ribbon Pack Refill for #8750 & #8755	LX300 / 300+ / 300+II and LX1050 / 1170 / 1170 II, FX1170	3 mil character / 17.7m, 58 ft x 13mm, 0.5"

www.epson.co.id/industrial-robots

ROBOT SOLUTION



Epson Robot

A proven reputation for precision and reliability at the leading edge of industrial robot design

Ever since we developed our first SCARA robots for wristwatch assembly over 40 years ago, Epson has been a leader in advanced robotics technology. Today, our long experience in energy-efficient, compact, high-precision technologies enables us to offer a wide range of slim, compact, and lightweight robots. And with the addition of original Epson force sensing and image processing technologies, we are achieving even higher levels of reliability, speed, precision, and productivity in process automation. Whatever challenges you face, Epson industrial robots are continuously evolving to meet the diversifying needs of manufacturers worldwide.

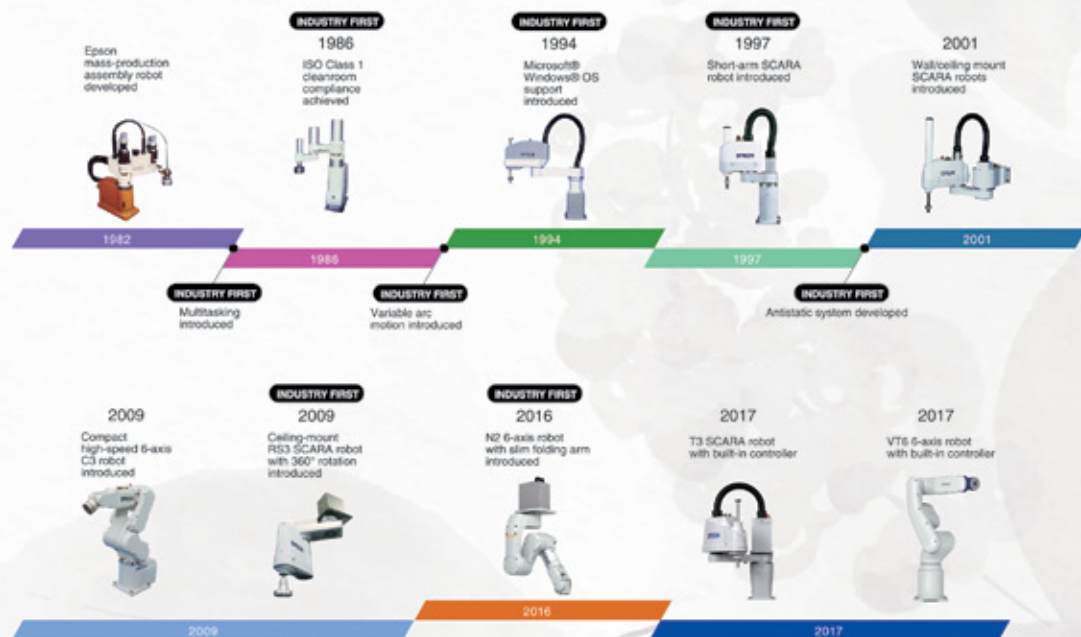

Why Epson Robots?

Epson, the global leader in robotics technology, offers you an impressive combination of high performance and operating ease. Backed by a worldwide reputation for reliability and outstanding customer support, Epson robots are bringing high-productivity automated manufacturing to an ever-expanding range of industries worldwide.



Low TCO and high reliability for the ultimate in automated productivity

High productivity

- Proprietary Epson technology reduces residual vibration to ensure high speed and precision for reduced takt time.
- Slim, lightweight body design reduces work cell space requirements while enabling higher productivity.

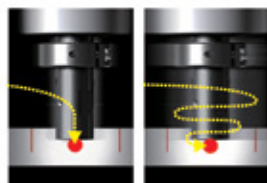

Epson robot

Conventional robot

High quality

- Extremely accurate toolhead positioning enables high-precision dispensing and cutting operations.



- Integrated machine vision systems boost setup ease and workpiece handling accuracy.

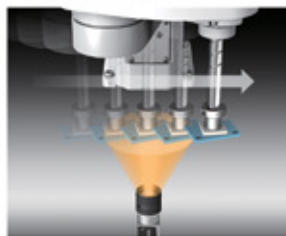

Easy operation

- Intuitive graphical interface makes programming easy even for first-time users.
- From program testing to full production, improved operating ease helps reduce cost and manpower requirements.



3D simulator for work cell layout and toolpath program testing

Software Integration



Global support

Epson supports robotics customers worldwide through an international network of sales and service offices, providing information about equipment configuration options and performing simulations of the tasks that customers want robots to perform. We are also partnered with systems integrators around the world, and can provide end-to-end turnkey solutions to meet virtually any process automation need.

ROBOT SOLUTION

Product lineup









	SCARA robots						
Epson Robot	G Series						
	Top-class speed, repeatability, and low residual vibration						
Publication page	▶P.9	▶P.11	▶P.15	▶P.17	▶P.21	▶P.23	▶P.23
Model name	G1	G3	NEW GX4	G6	NEW GX8	G10	G20
Payload (kg)	4-axis 3-axis 	Max 	Max 	Max 	Max 	Max 	Max 
Arm length (mm)							
Environmental specifications							
Installation specifications							
Compatible controller	RC700-A	RC700-A	RC700-D	RC700-A	RC700-D	RC700-A	RC700-A

ROBOT SOLUTION

SCARA robots							
LS Series				T Series		RS Series	
Proven reliability and functionality				Built-in controller for cost-efficient automation		Original space-saving design for high productivity	
▶ P.27	▶ P.29	▶ P.31	▶ P.33	▶ P.35	▶ P.37	▶ P.39	▶ P.41
LS3-B	LS6-B	LS10-B	LS20-B	NEW T3-B	NEW T6-B	RS3	RS4
							
Max 3	Max 6	Max 10	Max 20	Max 3	Max 6	Max 3	Max 4
400	500 600 700	600 700 800	800 1000	400	600	350	550
STD Class 3	STD Class 3	STD Class 3	STD Class 3	STD ²	STD ²	STD Class 3	STD Class 3
							
RC90-B	RC90-B	RC90-B	RC90-B	Built-in controller	Built-in controller	RC700-A	RC700-A



























	Standard
	Cleanroom model ISO 03 (Class 10 equiv.) ESD suppression
	Cleanroom model ISO 04 (Class 100 equiv.)
	Cleanroom model ISO 05 (Class 100 equiv.)
	Protection model IP54
	Protection model IP65
	Protection model IP67
	Table Top mount
	Wall mount
	Ceiling mount
	Wall/ceiling multi-layout mount

¹: See product page for details
²: IP20 ³: Standard model only

Controllers	
	Controllers ▶ P.59
Software	
	Software ▶ P.62
Vision systems	
	Vision systems ▶ P.67
Force-sensing systems	
	Force-sensing systems ▶ P.70
Options	
	Software options ▶ P.74
	Robot controller options ▶ P.76
	Manipulator options ▶ P.79
	Option quick-reference table ▶ P.80
	Option setup example ▶ P.81

ROBOT SOLUTION

Product lineup

	6-axis robots		
	C Series Slim, lightweight body for greater installation flexibility		
Publication page	▶ P.43	▶ P.45	▶ P.49
Model name	C4 	C8 	C12 
Payload (kg)	Max 	Max 	Max 
Arm length (mm)	 	  	
Environmental specifications		 	
Installation specifications	 	  	
Compatible controller			

ROBOT SOLUTION

6-axis robots			
N Series			VT
Original compact design for greater freedom of movement in tight quarters			Compact, easy setup, low TCO
► P.51	► P.53	► P.55	► P.57
N2	N6-A850	N6-A1000	VT6L
			
Max  2.5	Max  6	Max  6	Max  6
 450	 850	 1000	 900
	 	 	  
 		 	   
 RC700-A	 RC700-A	 RC700-A	 Built-in controller

-  **STD** Standard
 -  **Class 3** Cleanroom model ISO 03 (Class 10 equiv.) ESD suppression
 -  **Class 4** Cleanroom model ISO 04 (Class 100 equiv.)
 -  **Class 5** Cleanroom model ISO 05 (Class 100 equiv.)
 -  **IP54** Protection model IP54
 -  **IP65** Protection model IP65
 -  **IP67** Protection model IP67
 -  Table Top mount
 -  Wall mount
 -  Ceiling mount
 -  Wall/ceiling multi-layout mount
- *1: See product page for details
*2: IP20 *3: Standard model only
- Controllers**
 -  Controllers ► P.59
 - Software**
 -  Software ► P.62
 - Vision systems**
 -  Vision systems ► P.67
 - Force-sensing systems**
 -  Force-sensing systems ► P.70
 - Options**
 -  Software options ► P.74
 -  Robot controller options ► P.75
 -  Manipulator options ► P.79
 -  Option quick-reference table ► P.80
 -  Option setup example ► P.81

Vision systems

02 Vision Guide

Get advanced machine vision and image processing systems up and running fast with easy-to-use Epson Vision Guide software

- Built-in image processing engine assists vision-to-robot calibration, making it easy to align the robot's coordinate system with the camera's field of view.
- Workpiece position can be determined relative to robot coordinates without complex calculations.
- Image processing sequences can be created simply by entering a few parameters and pointing and clicking with a mouse.
- Advanced pattern matching and geometric search tools enable easy solution program development without writing a single line of code.

System configuration examples

CV-2A(HA, SA), L



PV1

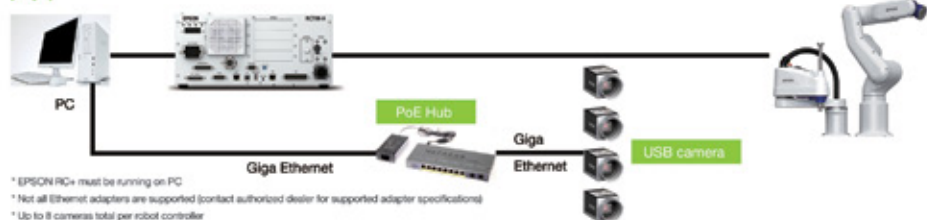

Features

Convenience

EPSON RC+ software can be used for both robot and machine vision program development.

- Other machine vision systems are more complicated to set up because different software must be used for machine vision and robot program development.

Ease of use

Easy registration of vision objects (positioning coordinates, etc.) enables rapid system setup and deployment.

- Vision objects can be registered via simple drag & drop operation.
- Intuitive interface makes operation easy even for first-time users.

● Robot & Vision Programming

- Vision & Guide Window
- Simulator
- Jog & Teach Window

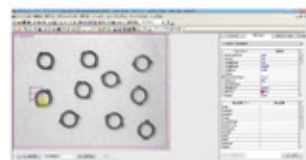

Vision simulation

Epson Vision software includes a simulator that lets you visualize robot operation and workflow before equipment is actually installed. This makes it easy to plan and configure the system for maximum productivity, and allow program development to proceed while the system is being constructed.

- Vision and process sequencing can be prepared in advance, before system is installed.
- Programs that include image processing sequences can be tested off line.
- If workpiece images are available, image processing can be tested off line.



Easy calibration

A built-in image processing engine makes it easy to align the camera's field of view with the robot's coordinate system, eliminating the need for complex programming when performing vision-to-robot calibration.

The robot automatically*1 follows the steps in the Calibration Wizard to complete the calibration.*2

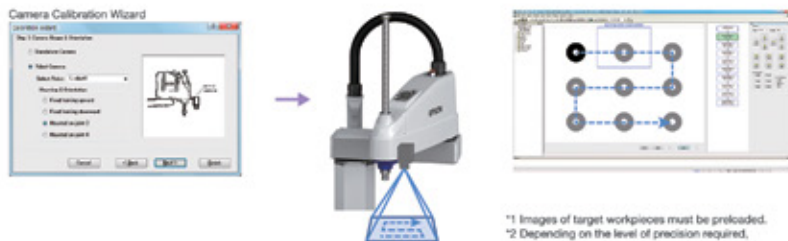

- *1 Images of target workpieces must be preloaded.
*2 Depending on the level of precision required, manual teaching may be necessary.

One-stop service

Whether you need help with initial setup or active production lines, Epson gives you one-stop service convenience for both robot and machine vision systems. With only one service call instead of two to coordinate, your production line will be back up and running in no time.

Force-sensing systems

High-rigidity, high-sensitivity S250 Series force sensors are specifically designed for use with Epson robots, enabling extremely precise force control for high-precision assembly tasks.

03 Force sensors

S250 Series force sensors incorporate exclusive Epson crystal piezoelectric technology that ensures a higher level of rigidity and sensitivity than conventional force sensors.

Advantage 1 high rigidity

S250 Series sensors are extremely rigid and resistant to deformation under heavy loads. They have a rated load of 250[N] on the X, Y, and Z axes, and a moment of force of 18[Nm] that makes them particularly sensitive to axial stress.

Advantage 2 high sensitivity

S250 Series sensors also ensure excellent sensitivity and quick response with high resolution of 0.1[N] and a low noise level of 0.035[N] on the X, Y, and Z axes.

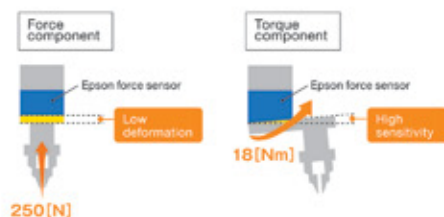

Force-sensing system applications

Robots equipped with an Epson S250 Series force sensing system can handle high-precision tasks that cannot be safely automated with teaching or machine vision systems alone. As a result, even production processes that previously required experienced workers to handle delicate and easily damaged workpieces can be fully automated.

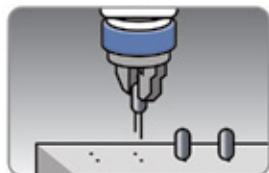

Delicate component assembly

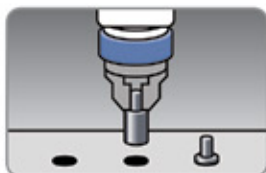

Precision mating

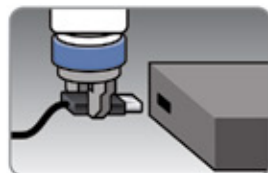

Connector insertion

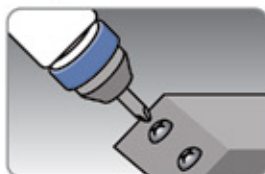

Precision screw assembly



Fine polishing

One-stop Epson support

From initial planning and procurement, to setup, adjustment, ongoing maintenance and re-pair, Epson provides one-stop support for all your force-sensing system and automation needs.



High-rigidity, high-sensitivity S250 Series force sensors are specifically designed for use with Epson robots, enabling extremely precise force control for high-precision assembly tasks.

Easy force sensing program development

The new Force Guide interface makes it easy to develop force sensor operating programs simply by dragging Force Guide object icons into a flow chart. In addition, simulator motion display and force waveform monitoring make debugging easier than ever before.



Force Guide GUI

The Force Guide interface provides a clear explanation of what each programming object does, as well as a flow chart view for easy confirmation of program sequence ordering.

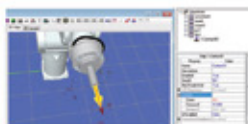

Simulator

The simulator enables quick confirmation of the direction of robot arm movement and axis coordinates.

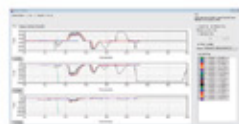

Force waveform display & recording

The force waveform display allows realtime waveforms to be compared with previously recorded waveforms, enabling users to identify operating anomalies and understand how various conditions affect performance.

Direct teaching function

6-axis robots equipped with force sensors can be taught using the Epson TP2/TP3 teaching pendant. Operators can manually move the robot arm and manipulator to the desired position and use the teaching pendant to confirm hardness/softness of the workpiece and the force to be applied.*

Touch-jog function*

In addition to the standard button-operated jog and teaching modes, the TP2 teaching pendant now has a direct teaching mode with a touch-jog function that makes 6-axis robot teaching much easier. During direct teaching operations, you can simply tap the effector to make small, incremental adjustments to the effector's position. There's no need to manually switch input modes because the system can automatically recognize the amount of force being applied to the effector.



* Supported by TP2 teaching pendant and C4, C8, N2, and N6 robots (controller firmware v7.4.5 or newer required)



Product photos

03 S250 Series force sensor



03 FS2 communication module



FS2 system requirements

Supported controller	RC700-A One FS2 module per controller (inserted in option slot)
No. of supported force sensors	One sensor per module
Power supply	Via option slot

System setup examples

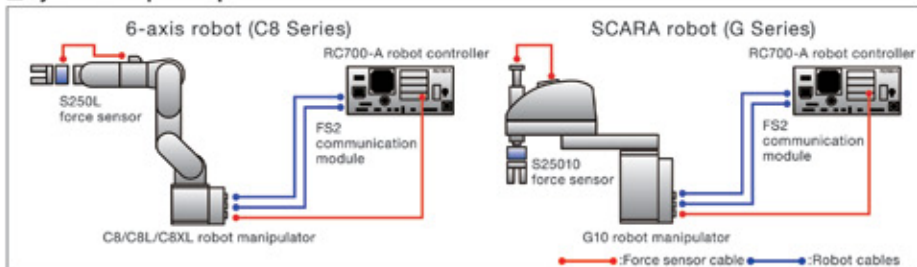

Robot controller options

A wide range of controller options are offered to expand the range of tasks and processes that can be automated.

04 Teaching Pendant (TP3)

Compatible controllers

RC090-A RC090-B T series VT series

Tablet-type teaching pendant with 10.1-inch color touchscreen for intuitive operation and fast, easy 6-axis robot teaching

Easy-to-view screen

- 10.1-inch TFT LCD (w/ LED backlight)
- 1280 x 800 resolution
- Color display



Easy operation

- Simple screen layout, fast response
- Standard RC+ program interface

Advanced features

- 3D robot graphics, programming functions and parameter settings
- High-speed test mode
- Programs can be started/stopped from operating panel

Main specifications

Dimensions (mm)	314(W) x 243(H) x 142(D)
Weight	1.5kg (including cable)
Body color	Black
Connectivity	Wired
Display	10.1-inch TFT LCD (w/ LED backlight)
	Resolution: 1280 x 800
Controls	Touchscreen controls
	Emergency stop button
	Enable switch
	Mode switch
	Control keys (Jog, EXE buttons)
	USB port
Cable length	5m (70m, 15m extension cables available)
Interface languages	English, Japanese, German, French, Chinese (simplified, traditional)
Ingress protection	IP65
Operating temperature range	0–42°C (stable temperature)
Operating humidity range	5–95% (relative humidity)
Operating environment	Low levels of dust, oil mist, salt, iron particles and other contaminants
	No flammable or caustic liquids or gases nearby

External dimensions

[Unit: mm]

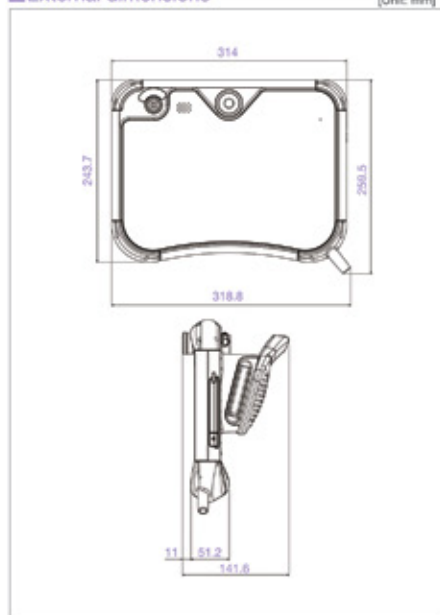

04 Teaching Pendant (TP2)

Compatible controllers
RC100-A RC30-B T series VT series

Easy-to-use pendant for teaching

- Universal design ensures ease of use for both right-handed and left-handed operators.
- Connects directly to operator unit or controller interface card.



05 Conveyor tracking

Compatible controllers
RC100-A RC30-B T series VT series

Precision tracking for high-productivity pick-and-place operation

- Enables pick-and-place handling of items on a high-speed conveyor.
- Uses machine vision/sensors to detect workpiece and effect robot handling.
- Can automate manual kitting/packaging tasks and help maintain productivity regardless of continuous/intermittent conveyor operation. Can also be used for workpiece assembly.
- Simple start/stop program execution.

*Vision Guide software required.

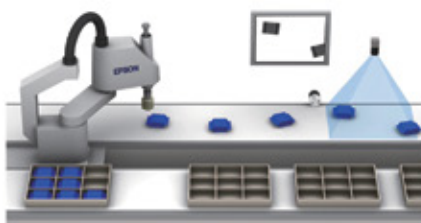

05 PG motion system

Compatible controllers
RC100-A RC30-B T series VT series

Control peripheral robots for fully integrated process automation

- EPSON RC+ software and pulse generator (PG) cards enable control of multiple third-party drives and motors.
- PG robots and standard EPSON RC+ system robots can be operated simultaneously, and controlled using the same commands.
- PG cards can be used to control X/Y tables, sliders, turrets,

and a wide range of other production/inspection line peripherals.

- Each PG card has 4 channels, and can support from 1 to 4 robots. Up to 4 cards can be mounted.

*PG motion system requires optional EPSON RC+ software and at least one optional PG output board. Drivers and motors for third-party devices are not included.

Robot controller options

06 Emergency stop switch

Compatible controllers
RC050A RC060B T-series VT-series

Helps prevent injuries and damage

- Immediately stops robot operation in emergency situations.



07 RS-232C cards

Compatible controllers
RC050A RC060B T-series VT-series

Expanded serial port connectivity

- 2-port RS-232C cards to connect serial interface devices.



08 I/O expansion cards

Compatible controllers
RC050A RC060B T-series VT-series

Expanded input/output flexibility

- 24-input/16-output expansion cards.



09 Fieldbus I/O (slave)

Compatible controllers
RC050A RC060B T-series VT-series

High-speed peripheral connectivity

- 2048-point I/O support for DeviceNet™, Ethernet/IP™, PROFIBUS®, and PROFINET® networked peripherals, and 384-point I/O support for CC-Link® networked peripherals.

10 Fieldbus I/O (master)

Compatible controllers
RC050A RC060B T-series VT-series

Bidirectional high-speed peripheral connectivity

- Support for DeviceNet™, PROFIBUS®, and Ethernet/IP™ networked peripherals (1024-point I/O).

11 Analog I/O card

Compatible controllers
RC050A RC060B T-series VT-series

For analog control of voltage and current I/O

- Analog control of input and output current and voltage allows regulation of secondary equipment such as paint sprayers to match the speed of robot arm motion. Available in 1 channel and 4 channel models.



12 EUROMAP 67 card

Compatible controllers
RC050A RC060B T-series VT-series

For use with thermoplastic injection molding machines

- EUROMAP 67 compliant electrical interface with 15-point input and 16-point output.



13 I/O cable kit

Compatible controllers
RC050A RC060B T-series VT-series

Cables and connectors for easy connectivity with no soldering required

- A wide range of I/O cables and connectors are available.



14 Hot plug kit

Compatible controllers
RC050A RC060B T-series VT-series

Easy Teach Pendant connection/disconnection

- Allows Teach Pendant to be connected or disconnected without an emergency stop.

*Conversion cable required for use with TP1 or TP2.



15 Wall mount option

Compatible controllers
RC050A RC060B T-series VT-series

Optional wall mounting box

- Allows controller to be mounted on a wall.



ROBOT SOLUTION

Option quick-reference table

Software options					
	RC700-A	RC700-D	RC90-B	T series	VT
02 Vision Guide 7.0	●	●	●	●	●
03 Force Guide 7.0	●	●	—	—	—
RC+ API 7.0	●	●	●	●	●
ECP	●	●	●	●	●
GUI Builder 7.0	●	●	●	●	●
OCR	●	●	●	●	●
VRT	●	●	●	●	●

Controller options					
	RC700-A	RC700-D	RC90-B	T series	VT
04 Teaching Pendant (TP2)	●	●	●	●	●
04 Teaching Pendant (TP3)	●	●	—	●	●
05 Conveyor tracking	●	●	●	—	—
05 PG motion system	●	●	●	—	—
06 Emergency stop switch	●	●	●	●	●
07 RS-232C cards	●	●	●	—	—
08 I/O expansion cards	●	●	●	—	—
09 Fieldbus I/O (Slave)	●	●	●	●	●
10 Fieldbus I/O (Master)	●	●	●	●	●
11 Analog I/O card	●	●	●	—	—
12 EUROMAP 67 card	●	●	●	—	—
13 I/O cable kit	●	●	●	—	—
14 Hot plug kit	●	●	—	●	●
15 Wall mount option	●	●	—	—	—

Manipulator options															
	Q1	Q3	Q1X	Q6	Q18	Q19/20	LS1/S6/LS1/S20	T3-B788	R31R54	Q4	Q8	12	N6	VT8	
16 External wiring units	—	—	—	●	●	●	—	—	—	—	—	—	—	●	
17 Internal wiring unit	—	—	—	—	—	—	—	—	●	—	—	—	—	—	
18 18 Tool adapters/ISO flanges	—	●	●	●	●	●	●	●	●	—	●	●	●	●	
20 Brake release units	—	—	—	—	—	—	—	—	—	●	●	●	●	—	
24 Power and signal cables	●	●	●	●	●	●	●	(built-in controller)	●	●	●	●	●	(built-in controller)	
Cable length (m)	3,5,10,15,20						3,5,10		3,5,10,15,20						
Cable type (Standard/High-flex)	Standard						Standard		Standard	Standard/High-flex	Standard	Standard/High-flex	Standard/High-flex		
22 Power cable connectors (Straight/L-type)	Straight/L-type						Standard		Straight/L-type						
23 Camera mounting bracket	—	●	●	●	●	●	●	●	●	●	●	●	●	●	
RC700DU-A (Drive unit)	●	●	—	●	—	●	—	—	●	●	●	—	●	—	

RC700-A controller with C series robots

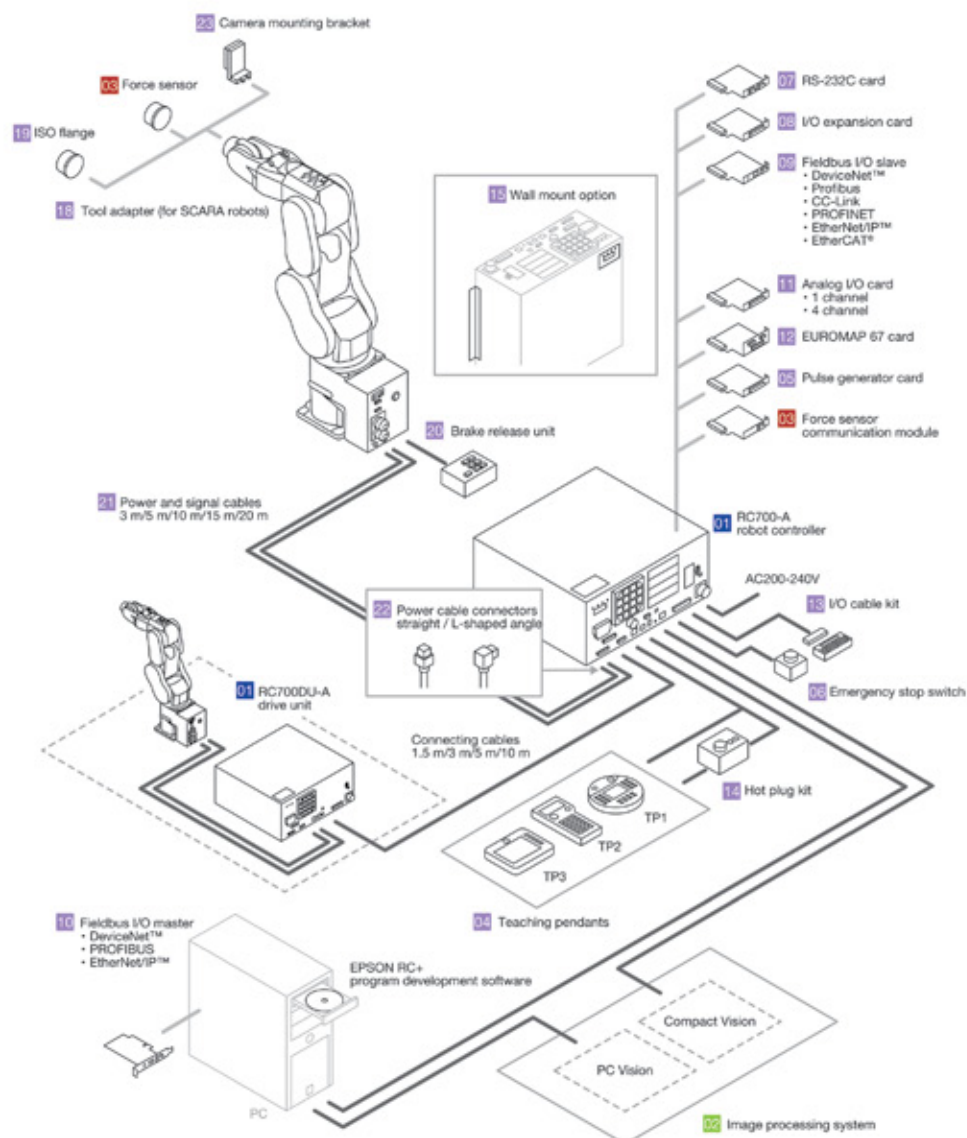

Option setup example

RC90-B controller

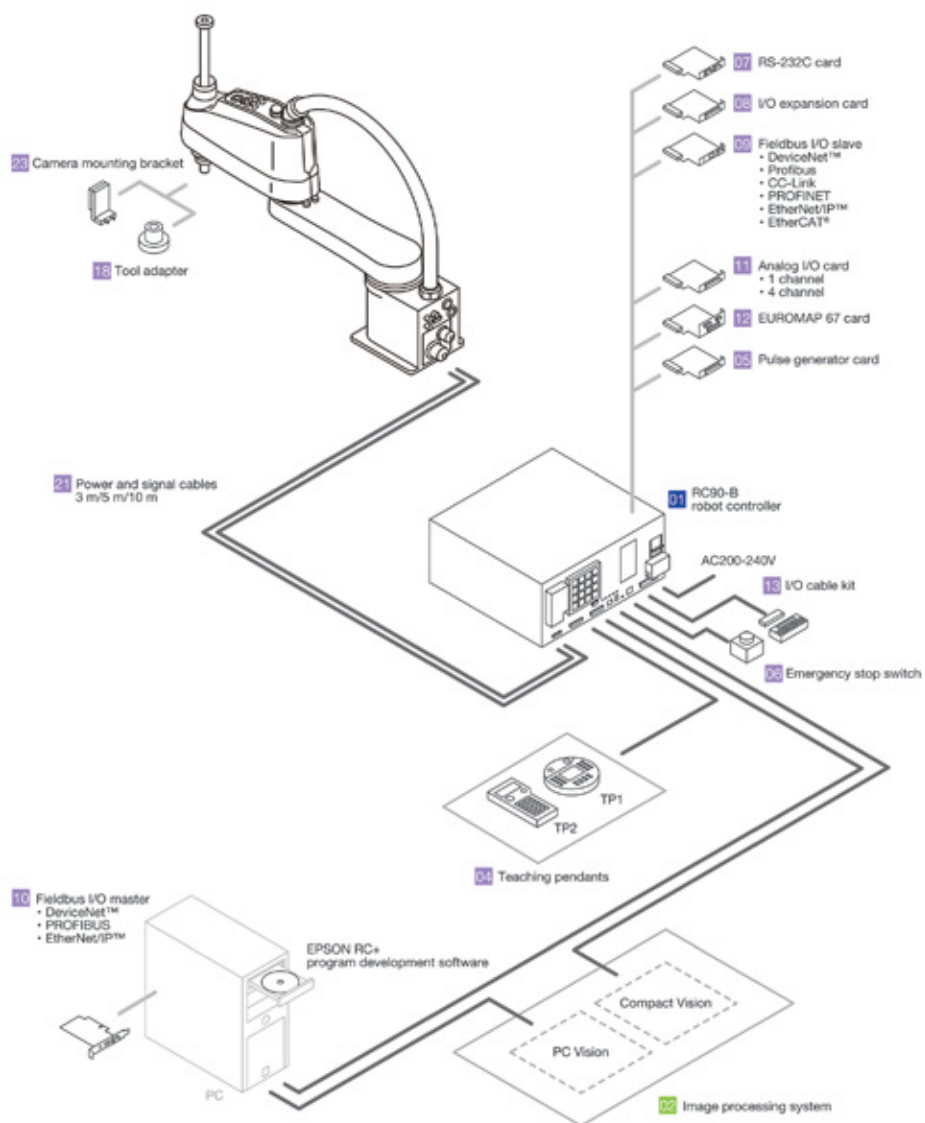

T series robot

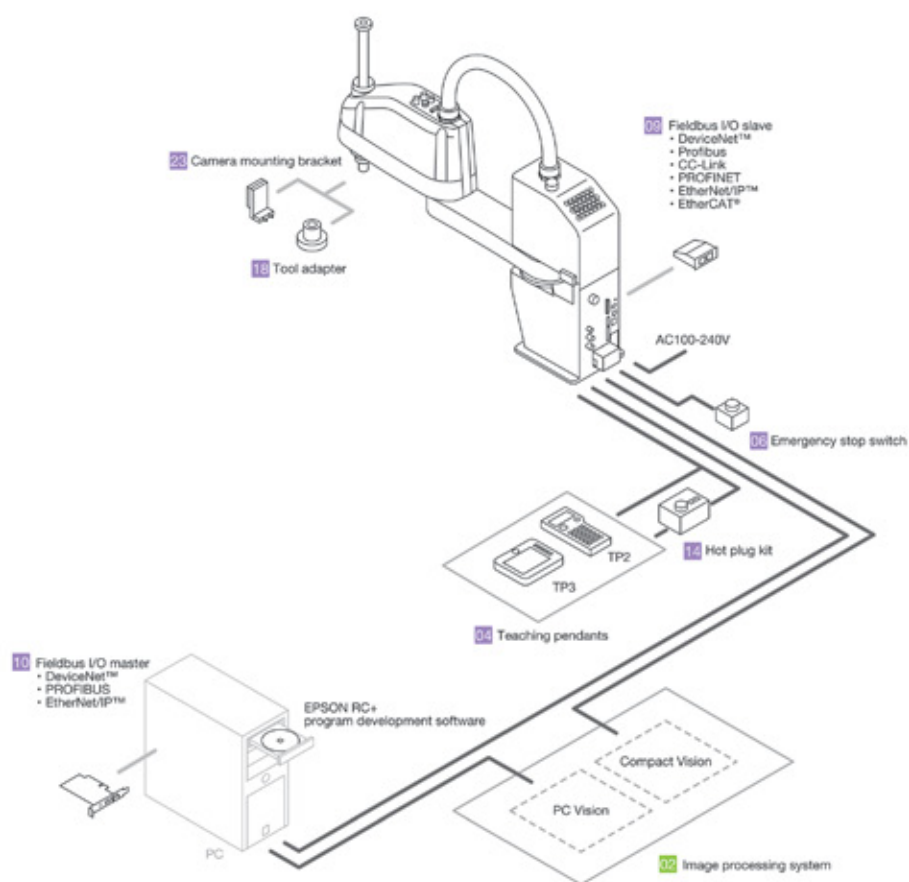

ROBOT SOLUTION

Option setup example

VT series robot

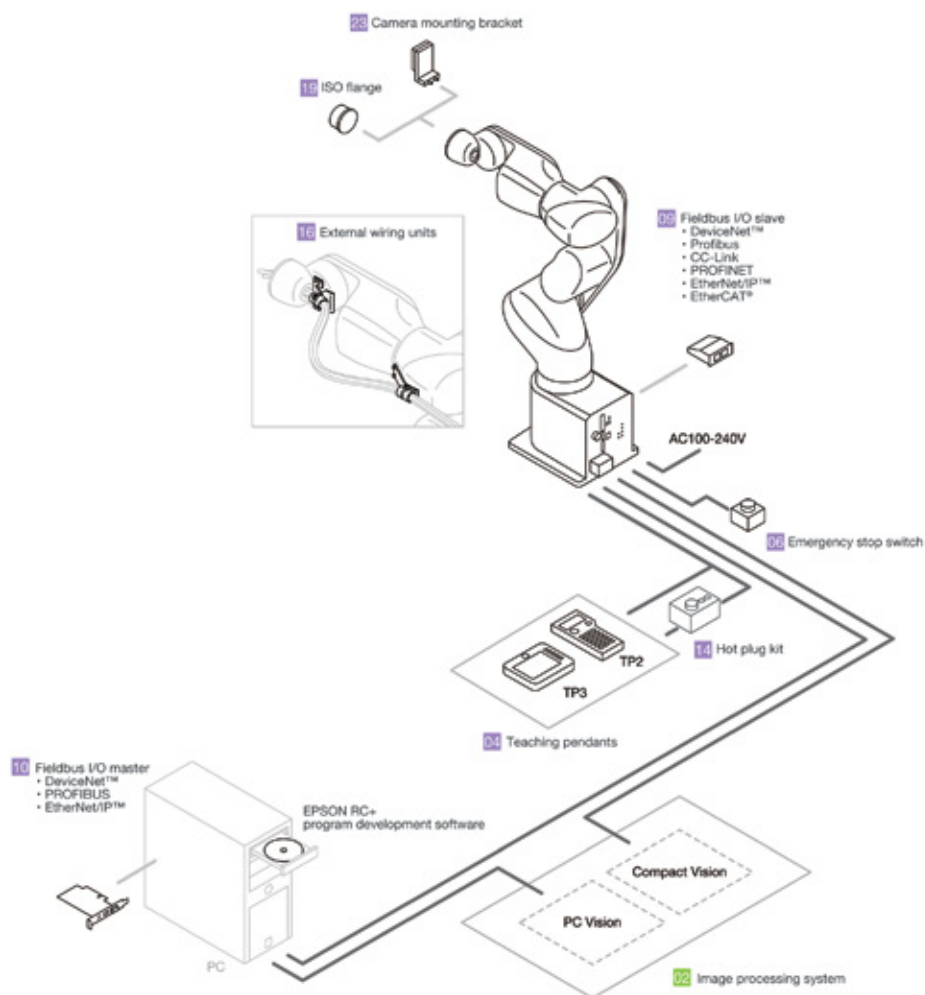

BRINGING AUTOMATION TO THE NEXT LEVEL.

ROBOT SOLUTION



Epson Robots are built for greater efficiency and precision while fusing form and function. Equipped with an optional complementary force sensor that is both sensitive and versatile, the robots are capable of executing a wide range of high precision tasks. Details make all the difference in the world of automation. Experience lower production costs, enhanced quality and increased productivity with Epson's highly reliable robots, while increasing businesses' bottom line.



IT'S IN THE DETAILS.

A global leader in precision robotics, Epson robots redefine reliability, accuracy and speed

EPSON

TRANSFORMATION. DETAILS MAKE THE DIFFERENCE.

All-in-one SCARA T3

Space-saving compact design, built-in controller for simple configuration – ensures high productivity with maximum downtime, significantly reducing total cost of ownership.

Folding-arm 6-Axis N2

All-new folding arm mechanism – a world-first 6-axis robot design – enables complex, high-precision assembly tasks to be performed in extremely limited spaces.

Compact 6-Axis C8

High performance in a slimline package, allows payloads up to 8kg while maintaining fast speeds and cycle times. Water and dust resistant. Can be wall or ceiling mounted.

Long-reach SCARA LS6

Absorbs reach and payload capacity, small footprint, proven reliability with outstanding functionality and cost-performance for pick-and-place and assembly tasks.

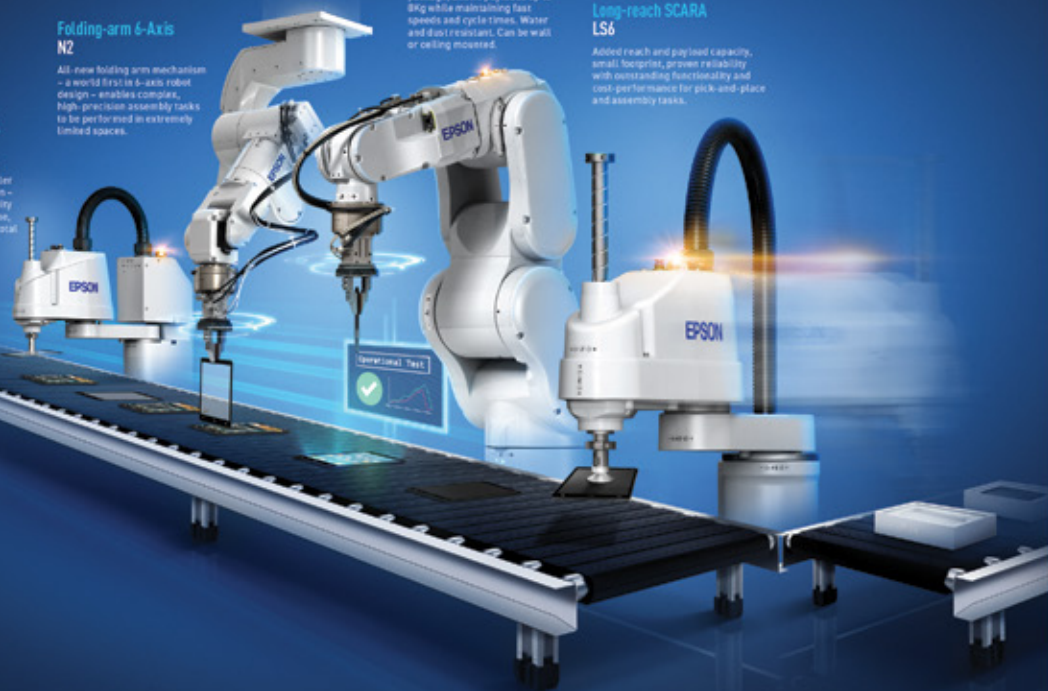

Enjoy the advantages of automation with Epson Robots.

Some manufacturing industries seek automation, but require the tools to upgrade from manual production. Others want to learn more about the possibilities and benefits of automation before progressing.

Whatever stage you're at right now, take a look at the advantages of the industry-changing technology built into Epson robots. With incredible sensitivity, our amazingly-precise, outstandingly-reliable robots complete tasks that previously defied automation. Enabling solutions that increase your productivity and enhance your reputation, while reducing your costs.

Transform your production line and your bottom line, with Epson. Remember, it's in the details. epson.co.id/industrial-robots

EPSON



20 PRODUCT 23 CATALOGUE

EPSON

PT EPSON INDONESIA

CIBIS Tower 9, 3rd Floor, Cibis Business Park
Jalan T.B. Simatupang No. 2 Jakarta 12560
Tel. [021] 808-66-766 Fax. [021] 808-66-799

 **1-500-766**

 **0812-12-37766**

HOTLINE CALL CENTER
(NATIONAL AREA)

Follow us
 **@EpsonIndonesia**
www.twitter.com/EpsonIndonesia

Become our fans
 **Epson Indonesia**
www.fb.com/EpsonIndonesia

Follow Us
 **Epson Indonesia**
www.linkedin.com/company/epson-indonesia

Follow Us
 **EpsonIndonesia**
www.instagram.com/EpsonIndonesia

Follow us
 **@epsonindonesia**
www.tiktok.com/@epsonindonesia

Visit Us
 **Epson Indonesia**
www.youtube.com/EpsonIndonesia

Visit Us
 **Epson Indonesia**
www.epson.co.id